

# The New Meccano Motor Chassis

## Fine Example of the Latest Meccano Construction

(Concluded from Last Month)

THE back axle, which really consists of a fixed hollow casing, is represented in the model by a framework of Strips, etc., that provides suitable bearings for the two axle shafts and also forms a rigid connection between the fixed portions of the rear wheel brakes (see Fig. 8).

The differential is housed in the back axle between two Wheel Flanges 26 and 26a, each of which is bolted against the inner side of a  $2\frac{1}{2} \times 1\frac{1}{2}$ " Double Angle Strip. These Angle Strips are secured rigidly together by means of 3" Strips 26b, and their centre holes form the inner bearings for the axle shafts 27 and 28. In addition, shaft 28 passes through the centre hole of a  $2\frac{1}{2} \times \frac{1}{2}$ " Double Angle Strip 29 bolted to the Wheel Flange 26a. One Washer should be placed between the Wheel Flange and the Angle Strip 29 on each of the bolts that hold the latter in position. The rear wheel brake mountings consist of two Face Plates 30 bolted rigidly to the back axle casing, one being secured to the ends of two 1" Reversed Angle Brackets and the other to the ends of two  $2\frac{1}{2} \times \frac{1}{2}$ " Double Angle Strips.

### The Torque Rods

The rear axle casing (Fig. 7) performs several important functions in addition to that of providing rigid bearings for the shafts secured to the road wheels. Besides carrying the weight of the vehicle, it must absorb the torque or twisting reaction set up by the propeller shaft, and also transmit the thrust of the road wheels to the chassis. The torque set up in the back axle will be understood more clearly by studying the action of the drive transmission between the propeller shaft and the road wheels. Suppose that this is effected by a bevel pinion on the propeller shaft driving a larger bevel gear secured to an unbroken axle carrying the two road wheels: when the engine rotates, the small bevel pinion on the propeller shaft will endeavour to rotate the bevel wheel on the back axle but since this naturally is somewhat difficult to move, the pinion will tend to travel round the bevel wheel while the latter remains stationary. This state of affairs possibly might result in a snapped propeller shaft and even broken springs, owing to the twisting movement imparted to the axle casing.

It is to counteract these stresses and strains that motor vehicles are fitted with what are known as torque rods. Many car manufacturers obtain the required results by enclosing the propeller shaft in a torque tube, which not only forms a torque reaction resistance, but also receives the forward thrust of the back axle. In the Meccano model the torque rods are shown quite separately from the propeller shaft, so that their functions may be understood more readily.

The torque rods consist of two  $5\frac{1}{2}$ " Strips 31 secured to the ends of the  $2\frac{1}{2} \times \frac{1}{2}$ " Double Angle Strip 29. These  $5\frac{1}{2}$ " Strips taper together at their other ends, where they are secured to a Collar 32 by means of an ordinary bolt inserted in place of the grub screw. Two Washers

should be placed beneath the head of this bolt to prevent its shank from binding on the  $\frac{1}{2}$ " Bolt 33, about which the Collar is free to pivot. The latter bolt, in turn, is inserted in another Collar 34 that is capable of turning about a Pivot Bolt secured to the  $5\frac{1}{2}$ " Girder 2, which forms the main cross member of the frame (see Fig. 2). A Compression Spring (part No. 120b) is placed between the Collar and the Girder to act as a shock absorber when the back axle is forced up and down by irregularities in the road surface.

It will now be seen that the torque rods 31 effectively counteract any twisting tendency in the back axle without interfering with the free vertical movement of the latter as a whole or the independent movement of one or other of the rear wheels.

The back axle casing is secured to the rear cantilever springs by an Angle Bracket 35 secured to each Face Plate 30. These Angle Brackets are bolted to the end holes of the springs, as will be seen in Fig. 2.

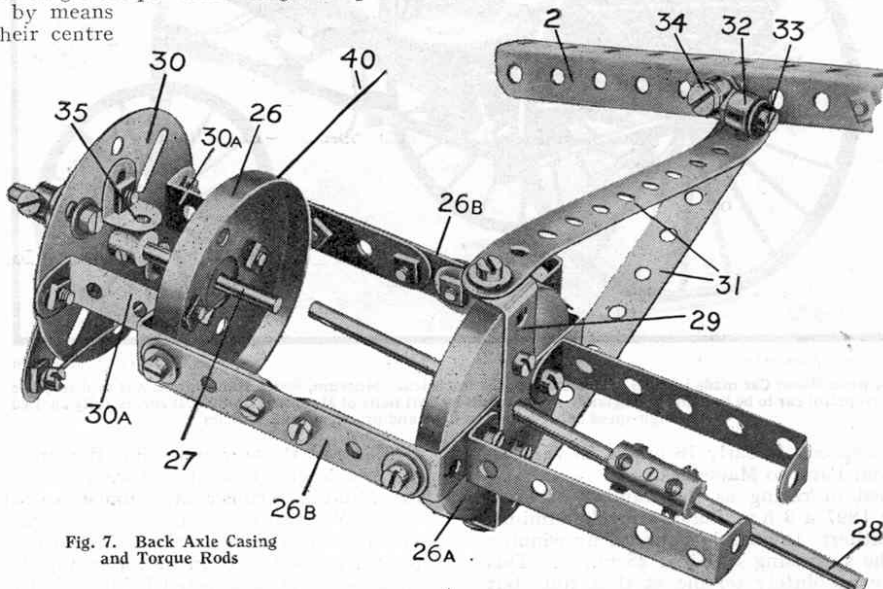

Fig. 7. Back Axle Casing and Torque Rods

### Brake Mechanism

One of the rear wheel brakes is shown in detail in Fig. 8, and it will be seen that it is of the internal expanding type. Two  $\frac{1}{2}$ " Bolts are passed through opposite slots in the Face Plate 30 and their ends, after passing through  $1\frac{1}{2}$ " Strips 36, are secured in Collars 37, which form the brake shoes. Each  $\frac{1}{2}$ " Bolt carries a Washer under its head and two on its shank between the Face Plate and the  $1\frac{1}{2}$ " Strips 36. The latter Strips are pivoted by means of bolts and lock nuts to a  $2\frac{1}{2}$ " Strip 38 that is free to turn about the axle shaft 27. When the  $2\frac{1}{2}$ " Strip is moved, the Collars are thrust outward along the slots by means of the links 36 and pressed against the inside periphery of a Wheel Flange 39 bolted to the inside of the road wheel. Three Washers should be placed on the axle 27 between the Strip 38 and the Face Plate. Care should be taken to see that the  $\frac{1}{2}$ " Bolts are able to move quite freely to and fro in the slots of the Face Plate.

The grub screws in the Collars 37 have been replaced by  $7/32$ " Meccano Bolts, and these are used to secure a short length of Spring Cord. The latter serves to withdraw the brake shoes 37 and return the brake to the "off" position when the Strip 38 is released. The road wheel should be placed on the axle 27 with the Wheel Flange 39 towards the Collars 37, care being taken to see that the latter have plenty of room to move before the road wheel is secured rigidly to the axle.

Each brake rod 40 (see Figs. 2 and 8) consists of two Meccano loom Healds bolted together (a length of cord will serve almost as well in their place if preferred). The Healds are connected pivotally at one end to the Strip 38 by means of a bolt and two nuts (see S.M. 262) and at the other end by a similar method to a

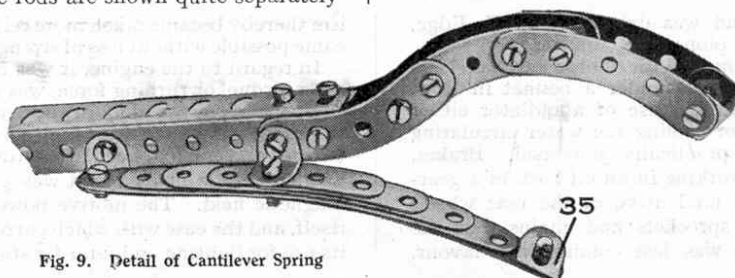

Fig. 9. Detail of Cantilever Spring

# The New Meccano Motor Chassis

## Fine Example of the Latest Meccano Construction

(Concluded from Last Month)

THE back axle, which really consists of a fixed hollow casing, is represented in the model by a framework of Strips, etc., that provides suitable bearings for the two axle shafts and also forms a rigid connection between the fixed portions of the rear wheel brakes (see Fig. 8).

The differential is housed in the back axle between two Wheel Flanges 26 and 26a, each of which is bolted against the inner side of a  $2\frac{1}{2} \times 1\frac{1}{2}$ " Double Angle Strip. These Angle Strips are secured rigidly together by means of 3" Strips 26b, and their centre holes form the inner bearings for the axle shafts 27 and 28. In addition, shaft 28 passes through the centre hole of a  $2\frac{1}{2} \times \frac{1}{2}$ " Double Angle Strip 29 bolted to the Wheel Flange 26a. One Washer should be placed between the Wheel Flange and the Angle Strip 29 on each of the bolts that hold the latter in position. The rear wheel brake mountings consist of two Face Plates 30 bolted rigidly to the back axle casing, one being secured to the ends of two 1" Reversed Angle Brackets and the other to the ends of two  $2\frac{1}{2} \times \frac{1}{2}$ " Double Angle Strips.

### The Torque Rods

The rear axle casing (Fig. 7) performs several important functions in addition to that of providing rigid bearings for the shafts secured to the road wheels. Besides carrying the weight of the vehicle, it must absorb the torque or twisting reaction set up by the propeller shaft, and also transmit the thrust of the road wheels to the chassis. The torque set up in the back axle will be understood more clearly by studying the action of the drive transmission between the propeller shaft and the road wheels. Suppose that this is effected by a bevel pinion on the propeller shaft driving a larger bevel gear secured to an unbroken axle carrying the two road wheels: when the engine rotates, the small bevel pinion on the propeller shaft will endeavour to rotate the bevel wheel on the back axle but since this naturally is somewhat difficult to move, the pinion will tend to travel round the bevel wheel while the latter remains stationary. This state of affairs possibly might result in a snapped propeller shaft and even broken springs, owing to the twisting movement imparted to the axle casing.

It is to counteract these stresses and strains that motor vehicles are fitted with what are known as torque rods. Many car manufacturers obtain the required results by enclosing the propeller shaft in a torque tube, which not only forms a torque reaction resistance, but also receives the forward thrust of the back axle. In the Meccano model the torque rods are shown quite separately from the propeller shaft, so that their functions may be understood more readily.

The torque rods consist of two  $5\frac{1}{2}$ " Strips 31 secured to the ends of the  $2\frac{1}{2} \times \frac{1}{2}$ " Double Angle Strip 29. These  $5\frac{1}{2}$ " Strips taper together at their other ends, where they are secured to a Collar 32 by means of an ordinary bolt inserted in place of the grub screw. Two Washers

should be placed beneath the head of this bolt to prevent its shank from binding on the  $\frac{1}{2}$ " Bolt 33, about which the Collar is free to pivot. The latter bolt, in turn, is inserted in another Collar 34 that is capable of turning about a Pivot Bolt secured to the  $5\frac{1}{2}$ " Girder 2, which forms the main cross member of the frame (see Fig. 2). A Compression Spring (part No. 120b) is placed between the Collar and the Girder to act as a shock absorber when the back axle is forced up and down by irregularities in the road surface.

It will now be seen that the torque rods 31 effectively counteract any twisting tendency in the back axle without interfering with the free vertical movement of the latter as a whole or the independent movement of one or other of the rear wheels.

The back axle casing is secured to the rear cantilever springs by an Angle Bracket 35 secured to each Face Plate 30. These Angle Brackets are bolted to the end holes of the springs, as will be seen in Fig. 2.

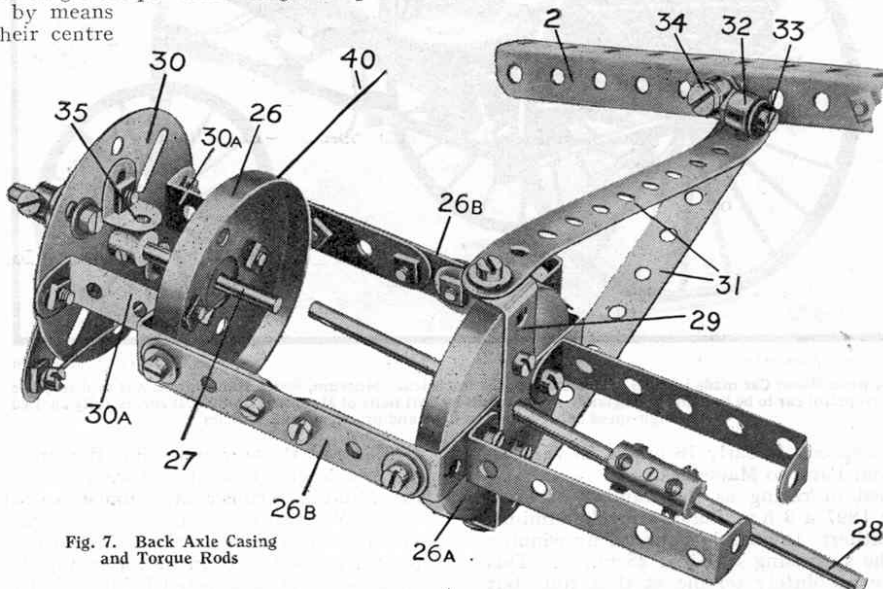

Fig. 7. Back Axle Casing and Torque Rods

### Brake Mechanism

One of the rear wheel brakes is shown in detail in Fig. 8, and it will be seen that it is of the internal expanding type. Two  $\frac{1}{2}$ " Bolts are passed through opposite slots in the Face Plate 30 and their ends, after passing through  $1\frac{1}{2}$ " Strips 36, are secured in Collars 37, which form the brake shoes. Each  $\frac{1}{2}$ " Bolt carries a Washer under its head and two on its shank between the Face Plate and the  $1\frac{1}{2}$ " Strips 36. The latter Strips are pivoted by means of bolts and lock nuts to a  $2\frac{1}{2}$ " Strip 38 that is free to turn about the axle shaft 27. When the  $2\frac{1}{2}$ " Strip is moved, the Collars are thrust outward along the slots by means of the links 36 and pressed against the inside periphery of a Wheel Flange 39 bolted to the inside of the road wheel. Three Washers should be placed on the axle 27 between the Strip 38 and the Face Plate. Care should be taken to see that the  $\frac{1}{2}$ " Bolts are able to move quite freely to and fro in the slots of the Face Plate.

The grub screws in the Collars 37 have been replaced by  $7/32$ " Meccano Bolts, and these are used to secure a short length of Spring Cord. The latter serves to withdraw the brake shoes 37 and return the brake to the "off" position when the Strip 38 is released. The road wheel should be placed on the axle 27 with the Wheel Flange 39 towards the Collars 37, care being taken to see that the latter have plenty of room to move before the road wheel is secured rigidly to the axle.

Each brake rod 40 (see Figs. 2 and 8) consists of two Meccano loom Healds bolted together (a length of cord will serve almost as well in their place if preferred). The Healds are connected pivotally at one end to the Strip 38 by means of a bolt and two nuts (see S.M. 262) and at the other end by a similar method to a

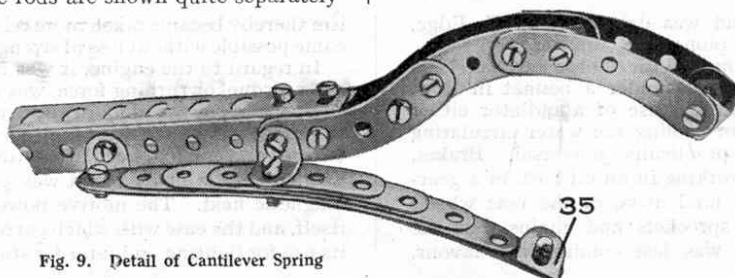

Fig. 9. Detail of Cantilever Spring



# The New Meccano Motor Chassis

## Fine Example of the Latest Meccano Construction

(Concluded from Last Month)

THE back axle, which really consists of a fixed hollow casing, is represented in the model by a framework of Strips, etc., that provides suitable bearings for the two axle shafts and also forms a rigid connection between the fixed portions of the rear wheel brakes (see Fig. 8).

The differential is housed in the back axle between two Wheel Flanges 26 and 26a, each of which is bolted against the inner side of a  $2\frac{1}{2} \times 1\frac{1}{2}$ " Double Angle Strip. These Angle Strips are secured rigidly together by means of 3" Strips 26b, and their centre holes form the inner bearings for the axle shafts 27 and 28. In addition, shaft 28 passes through the centre hole of a  $2\frac{1}{2} \times \frac{1}{2}$ " Double Angle Strip 29 bolted to the Wheel Flange 26a. One Washer should be placed between the Wheel Flange and the Angle Strip 29 on each of the bolts that hold the latter in position. The rear wheel brake mountings consist of two Face Plates 30 bolted rigidly to the back axle casing, one being secured to the ends of two 1" Reversed Angle Brackets and the other to the ends of two  $2\frac{1}{2} \times \frac{1}{2}$ " Double Angle Strips.

### The Torque Rods

The rear axle casing (Fig. 7) performs several important functions in addition to that of providing rigid bearings for the shafts secured to the road wheels. Besides carrying the weight of the vehicle, it must absorb the torque or twisting reaction set up by the propeller shaft, and also transmit the thrust of the road wheels to the chassis. The torque set up in the back axle will be understood more clearly by studying the action of the drive transmission between the propeller shaft and the road wheels. Suppose that this is effected by a bevel pinion on the propeller shaft driving a larger bevel gear secured to an unbroken axle carrying the two road wheels: when the engine rotates, the small bevel pinion on the propeller shaft will endeavour to rotate the bevel wheel on the back axle but since this naturally is somewhat difficult to move, the pinion will tend to travel round the bevel wheel while the latter remains stationary. This state of affairs possibly might result in a snapped propeller shaft and even broken springs, owing to the twisting movement imparted to the axle casing.

It is to counteract these stresses and strains that motor vehicles are fitted with what are known as torque rods. Many car manufacturers obtain the required results by enclosing the propeller shaft in a torque tube, which not only forms a torque reaction resistance, but also receives the forward thrust of the back axle. In the Meccano model the torque rods are shown quite separately from the propeller shaft, so that their functions may be understood more readily.

The torque rods consist of two  $5\frac{1}{2}$ " Strips 31 secured to the ends of the  $2\frac{1}{2} \times \frac{1}{2}$ " Double Angle Strip 29. These  $5\frac{1}{2}$ " Strips taper together at their other ends, where they are secured to a Collar 32 by means of an ordinary bolt inserted in place of the grub screw. Two Washers

should be placed beneath the head of this bolt to prevent its shank from binding on the  $\frac{1}{2}$ " Bolt 33, about which the Collar is free to pivot. The latter bolt, in turn, is inserted in another Collar 34 that is capable of turning about a Pivot Bolt secured to the  $5\frac{1}{2}$ " Girder 2, which forms the main cross member of the frame (see Fig. 2). A Compression Spring (part No. 120b) is placed between the Collar and the Girder to act as a shock absorber when the back axle is forced up and down by irregularities in the road surface.

It will now be seen that the torque rods 31 effectively counteract any twisting tendency in the back axle without interfering with the free vertical movement of the latter as a whole or the independent movement of one or other of the rear wheels.

The back axle casing is secured to the rear cantilever springs by an Angle Bracket 35 secured to each Face Plate 30. These Angle Brackets are bolted to the end holes of the springs, as will be seen in Fig. 2.

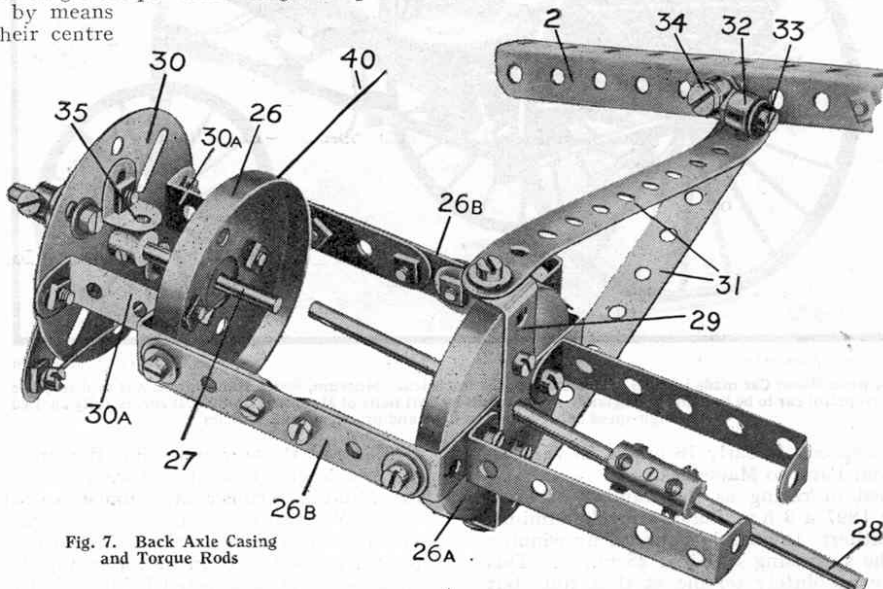

Fig. 7. Back Axle Casing and Torque Rods

### Brake Mechanism

One of the rear wheel brakes is shown in detail in Fig. 8, and it will be seen that it is of the internal expanding type. Two  $\frac{1}{2}$ " Bolts are passed through opposite slots in the Face Plate 30 and their ends, after passing through  $1\frac{1}{2}$ " Strips 36, are secured in Collars 37, which form the brake shoes. Each  $\frac{1}{2}$ " Bolt carries a Washer under its head and two on its shank between the Face Plate and the  $1\frac{1}{2}$ " Strips 36. The latter Strips are pivoted by means of bolts and lock nuts to a  $2\frac{1}{2}$ " Strip 38 that is free to turn about the axle shaft 27. When the  $2\frac{1}{2}$ " Strip is moved, the Collars are thrust outward along the slots by means of the links 36 and pressed against the inside periphery of a Wheel Flange 39 bolted to the inside of the road wheel. Three Washers should be placed on the axle 27 between the Strip 38 and the Face Plate. Care should be taken to see that the  $\frac{1}{2}$ " Bolts are able to move quite freely to and fro in the slots of the Face Plate.

The grub screws in the Collars 37 have been replaced by  $7/32$ " Meccano Bolts, and these are used to secure a short length of Spring Cord. The latter serves to withdraw the brake shoes 37 and return the brake to the "off" position when the Strip 38 is released. The road wheel should be placed on the axle 27 with the Wheel Flange 39 towards the Collars 37, care being taken to see that the latter have plenty of room to move before the road wheel is secured rigidly to the axle.

Each brake rod 40 (see Figs. 2 and 8) consists of two Meccano loom Healds bolted together (a length of cord will serve almost as well in their place if preferred). The Healds are connected pivotally at one end to the Strip 38 by means of a bolt and two nuts (see S.M. 262) and at the other end by a similar method to a

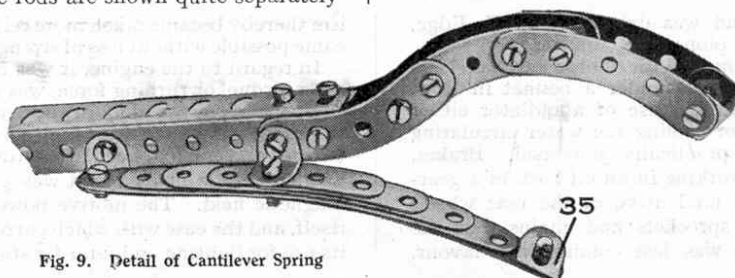

Fig. 9. Detail of Cantilever Spring

# The New Meccano Motor Chassis

## Fine Example of the Latest Meccano Construction

(Concluded from Last Month)

THE back axle, which really consists of a fixed hollow casing, is represented in the model by a framework of Strips, etc., that provides suitable bearings for the two axle shafts and also forms a rigid connection between the fixed portions of the rear wheel brakes (see Fig. 8).

The differential is housed in the back axle between two Wheel Flanges 26 and 26a, each of which is bolted against the inner side of a  $2\frac{1}{2} \times 1\frac{1}{2}$ " Double Angle Strip. These Angle Strips are secured rigidly together by means of 3" Strips 26b, and their centre holes form the inner bearings for the axle shafts 27 and 28. In addition, shaft 28 passes through the centre hole of a  $2\frac{1}{2} \times \frac{1}{2}$ " Double Angle Strip 29 bolted to the Wheel Flange 26a. One Washer should be placed between the Wheel Flange and the Angle Strip 29 on each of the bolts that hold the latter in position. The rear wheel brake mountings consist of two Face Plates 30 bolted rigidly to the back axle casing, one being secured to the ends of two 1" Reversed Angle Brackets and the other to the ends of two  $2\frac{1}{2} \times \frac{1}{2}$ " Double Angle Strips.

### The Torque Rods

The rear axle casing (Fig. 7) performs several important functions in addition to that of providing rigid bearings for the shafts secured to the road wheels. Besides carrying the weight of the vehicle, it must absorb the torque or twisting reaction set up by the propeller shaft, and also transmit the thrust of the road wheels to the chassis. The torque set up in the back axle will be understood more clearly by studying the action of the drive transmission between the propeller shaft and the road wheels. Suppose that this is effected by a bevel pinion on the propeller shaft driving a larger bevel gear secured to an unbroken axle carrying the two road wheels: when the engine rotates, the small bevel pinion on the propeller shaft will endeavour to rotate the bevel wheel on the back axle but since this naturally is somewhat difficult to move, the pinion will tend to travel round the bevel wheel while the latter remains stationary. This state of affairs possibly might result in a snapped propeller shaft and even broken springs, owing to the twisting movement imparted to the axle casing.

It is to counteract these stresses and strains that motor vehicles are fitted with what are known as torque rods. Many car manufacturers obtain the required results by enclosing the propeller shaft in a torque tube, which not only forms a torque reaction resistance, but also receives the forward thrust of the back axle. In the Meccano model the torque rods are shown quite separately from the propeller shaft, so that their functions may be understood more readily.

The torque rods consist of two  $5\frac{1}{2}$ " Strips 31 secured to the ends of the  $2\frac{1}{2} \times \frac{1}{2}$ " Double Angle Strip 29. These  $5\frac{1}{2}$ " Strips taper together at their other ends, where they are secured to a Collar 32 by means of an ordinary bolt inserted in place of the grub screw. Two Washers

should be placed beneath the head of this bolt to prevent its shank from binding on the  $\frac{1}{2}$ " Bolt 33, about which the Collar is free to pivot. The latter bolt, in turn, is inserted in another Collar 34 that is capable of turning about a Pivot Bolt secured to the  $5\frac{1}{2}$ " Girder 2, which forms the main cross member of the frame (see Fig. 2). A Compression Spring (part No. 120b) is placed between the Collar and the Girder to act as a shock absorber when the back axle is forced up and down by irregularities in the road surface.

It will now be seen that the torque rods 31 effectively counteract any twisting tendency in the back axle without interfering with the free vertical movement of the latter as a whole or the independent movement of one or other of the rear wheels.

The back axle casing is secured to the rear cantilever springs by an Angle Bracket 35 secured to each Face Plate 30. These Angle Brackets are bolted to the end holes of the springs, as will be seen in Fig. 2.

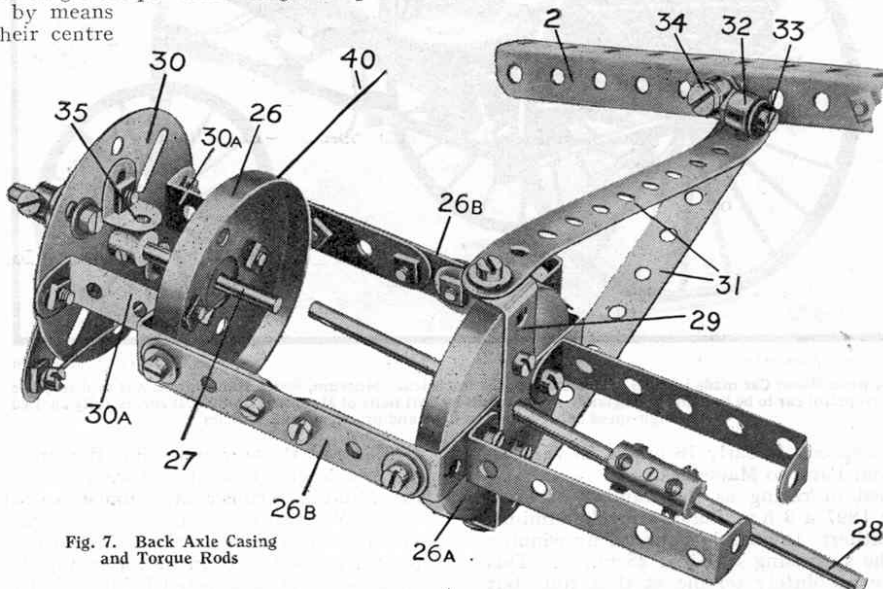

Fig. 7. Back Axle Casing and Torque Rods

### Brake Mechanism

One of the rear wheel brakes is shown in detail in Fig. 8, and it will be seen that it is of the internal expanding type. Two  $\frac{1}{2}$ " Bolts are passed through opposite slots in the Face Plate 30 and their ends, after passing through  $1\frac{1}{2}$ " Strips 36, are secured in Collars 37, which form the brake shoes. Each  $\frac{1}{2}$ " Bolt carries a Washer under its head and two on its shank between the Face Plate and the  $1\frac{1}{2}$ " Strips 36. The latter Strips are pivoted by means of bolts and lock nuts to a  $2\frac{1}{2}$ " Strip 38 that is free to turn about the axle shaft 27. When the  $2\frac{1}{2}$ " Strip is moved, the Collars are thrust outward along the slots by means of the links 36 and pressed against the inside periphery of a Wheel Flange 39 bolted to the inside of the road wheel. Three Washers should be placed on the axle 27 between the Strip 38 and the Face Plate. Care should be taken to see that the  $\frac{1}{2}$ " Bolts are able to move quite freely to and fro in the slots of the Face Plate.

The grub screws in the Collars 37 have been replaced by  $7/32$ " Meccano Bolts, and these are used to secure a short length of Spring Cord. The latter serves to withdraw the brake shoes 37 and return the brake to the "off" position when the Strip 38 is released. The road wheel should be placed on the axle 27 with the Wheel Flange 39 towards the Collars 37, care being taken to see that the latter have plenty of room to move before the road wheel is secured rigidly to the axle.

Each brake rod 40 (see Figs. 2 and 8) consists of two Meccano loom Healds bolted together (a length of cord will serve almost as well in their place if preferred). The Healds are connected pivotally at one end to the Strip 38 by means of a bolt and two nuts (see S.M. 262) and at the other end by a similar method to a

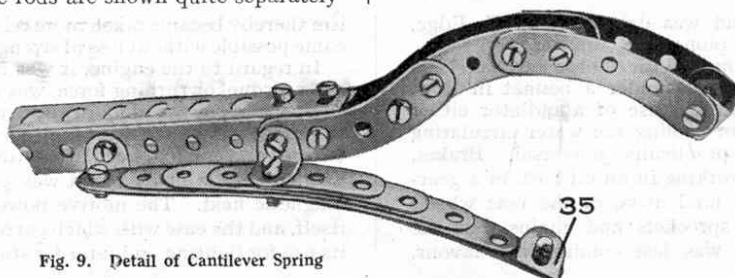

Fig. 9. Detail of Cantilever Spring



# The New Meccano Motor Chassis

## Fine Example of the Latest Meccano Construction

(Concluded from Last Month)

THE back axle, which really consists of a fixed hollow casing, is represented in the model by a framework of Strips, etc., that provides suitable bearings for the two axle shafts and also forms a rigid connection between the fixed portions of the rear wheel brakes (see Fig. 8).

The differential is housed in the back axle between two Wheel Flanges 26 and 26a, each of which is bolted against the inner side of a  $2\frac{1}{2} \times 1\frac{1}{2}$ " Double Angle Strip. These Angle Strips are secured rigidly together by means of 3" Strips 26b, and their centre holes form the inner bearings for the axle shafts 27 and 28. In addition, shaft 28 passes through the centre hole of a  $2\frac{1}{2} \times \frac{1}{2}$ " Double Angle Strip 29 bolted to the Wheel Flange 26a. One Washer should be placed between the Wheel Flange and the Angle Strip 29 on each of the bolts that hold the latter in position. The rear wheel brake mountings consist of two Face Plates 30 bolted rigidly to the back axle casing, one being secured to the ends of two 1" Reversed Angle Brackets and the other to the ends of two  $2\frac{1}{2} \times \frac{1}{2}$ " Double Angle Strips.

### The Torque Rods

The rear axle casing (Fig. 7) performs several important functions in addition to that of providing rigid bearings for the shafts secured to the road wheels. Besides carrying the weight of the vehicle, it must absorb the torque or twisting reaction set up by the propeller shaft, and also transmit the thrust of the road wheels to the chassis. The torque set up in the back axle will be understood more clearly by studying the action of the drive transmission between the propeller shaft and the road wheels. Suppose that this is effected by a bevel pinion on the propeller shaft driving a larger bevel gear secured to an unbroken axle carrying the two road wheels: when the engine rotates, the small bevel pinion on the propeller shaft will endeavour to rotate the bevel wheel on the back axle but since this naturally is somewhat difficult to move, the pinion will tend to travel round the bevel wheel while the latter remains stationary. This state of affairs possibly might result in a snapped propeller shaft and even broken springs, owing to the twisting movement imparted to the axle casing.

It is to counteract these stresses and strains that motor vehicles are fitted with what are known as torque rods. Many car manufacturers obtain the required results by enclosing the propeller shaft in a torque tube, which not only forms a torque reaction resistance, but also receives the forward thrust of the back axle. In the Meccano model the torque rods are shown quite separately from the propeller shaft, so that their functions may be understood more readily.

The torque rods consist of two  $5\frac{1}{2}$ " Strips 31 secured to the ends of the  $2\frac{1}{2} \times \frac{1}{2}$ " Double Angle Strip 29. These  $5\frac{1}{2}$ " Strips taper together at their other ends, where they are secured to a Collar 32 by means of an ordinary bolt inserted in place of the grub screw. Two Washers

should be placed beneath the head of this bolt to prevent its shank from binding on the  $\frac{1}{2}$ " Bolt 33, about which the Collar is free to pivot. The latter bolt, in turn, is inserted in another Collar 34 that is capable of turning about a Pivot Bolt secured to the  $5\frac{1}{2}$ " Girder 2, which forms the main cross member of the frame (see Fig. 2). A Compression Spring (part No. 120b) is placed between the Collar and the Girder to act as a shock absorber when the back axle is forced up and down by irregularities in the road surface.

It will now be seen that the torque rods 31 effectively counteract any twisting tendency in the back axle without interfering with the free vertical movement of the latter as a whole or the independent movement of one or other of the rear wheels.

The back axle casing is secured to the rear cantilever springs by an Angle Bracket 35 secured to each Face Plate 30. These Angle Brackets are bolted to the end holes of the springs, as will be seen in Fig. 2.

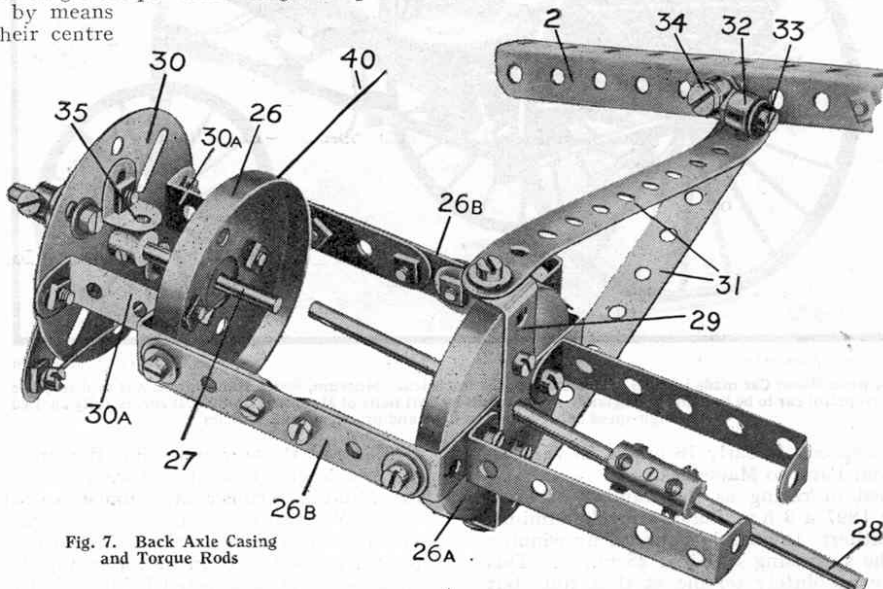

Fig. 7. Back Axle Casing and Torque Rods

### Brake Mechanism

One of the rear wheel brakes is shown in detail in Fig. 8, and it will be seen that it is of the internal expanding type. Two  $\frac{1}{2}$ " Bolts are passed through opposite slots in the Face Plate 30 and their ends, after passing through  $1\frac{1}{2}$ " Strips 36, are secured in Collars 37, which form the brake shoes. Each  $\frac{1}{2}$ " Bolt carries a Washer under its head and two on its shank between the Face Plate and the  $1\frac{1}{2}$ " Strips 36. The latter Strips are pivoted by means of bolts and lock nuts to a  $2\frac{1}{2}$ " Strip 38 that is free to turn about the axle shaft 27. When the  $2\frac{1}{2}$ " Strip is moved, the Collars are thrust outward along the slots by means of the links 36 and pressed against the inside periphery of a Wheel Flange 39 bolted to the inside of the road wheel. Three Washers should be placed on the axle 27 between the Strip 38 and the Face Plate. Care should be taken to see that the  $\frac{1}{2}$ " Bolts are able to move quite freely to and fro in the slots of the Face Plate.

The grub screws in the Collars 37 have been replaced by  $7/32$ " Meccano Bolts, and these are used to secure a short length of Spring Cord. The latter serves to withdraw the brake shoes 37 and return the brake to the "off" position when the Strip 38 is released. The road wheel should be placed on the axle 27 with the Wheel Flange 39 towards the Collars 37, care being taken to see that the latter have plenty of room to move before the road wheel is secured rigidly to the axle.

Each brake rod 40 (see Figs. 2 and 8) consists of two Meccano loom Healds bolted together (a length of cord will serve almost as well in their place if preferred). The Healds are connected pivotally at one end to the Strip 38 by means of a bolt and two nuts (see S.M. 262) and at the other end by a similar method to a

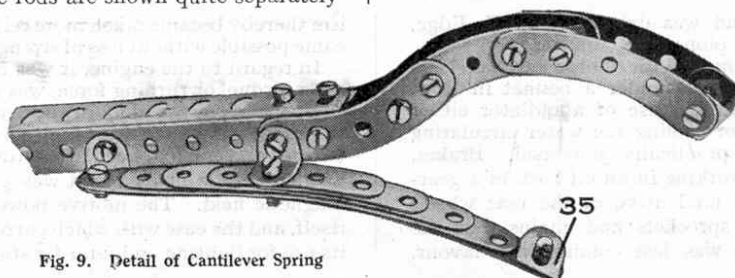
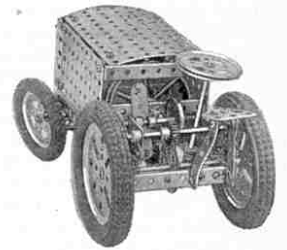

Fig. 9. Detail of Cantilever Spring

# Boys, you MUST have this new Book



Get a  
copy  
to-day  
**PRICE**  
**9d.**



Novel Momentum Tractor.

## DO IT NOW!

We advise every keen Meccano boy to obtain his copy of the Book of New Models now, while supplies are available.

The book contains illustrations and details of the best of the new models and new movements submitted in recent competitions, together with many others that have been designed by our own experts. All the models shown in the book are of outstanding interest and variety.

### HOW TO OBTAIN THE BOOK

The 1931 Book of New Models may be obtained from any Meccano dealer, price 9d., or direct from Meccano Ltd., Old Swan, Liverpool, price 10½d. post free.

There are special editions for Australia, New Zealand, South Africa and Canada and details of the prices of the book in these countries are as follows:—

**AUSTRALIA:** Price 2/- from dealers or 2/2 from E. G. Page & Co., 52, Clarence Street, Sydney. (P.O. Box 1832K).

**NEW ZEALAND:** Price 1/- from dealers or 1/2 from Models Ltd., P.O. Box 129, Auckland (Kingston Street).

**SOUTH AFRICA:** Price 1/- from dealers or 1/2 from Arthur E. Harris, 142, Market Street, Johannesburg. (P.O. Box 1199).

**CANADA:** Price 25 cents from dealers or 30 cents from Meccano Ltd., 34, St. Patrick Street, Toronto.

Readers living in countries other than those mentioned above should order from Meccano Ltd., Old Swan, Liverpool, England, sending a remittance of 1/2 with their orders.

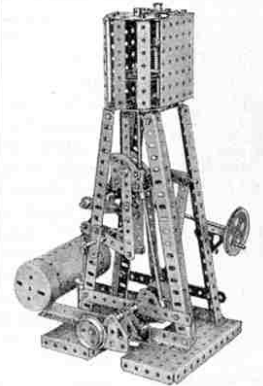

Single Cylinder Marine Engine.

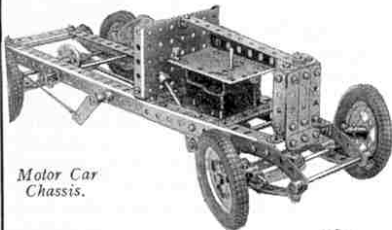

Motor Car Chassis.

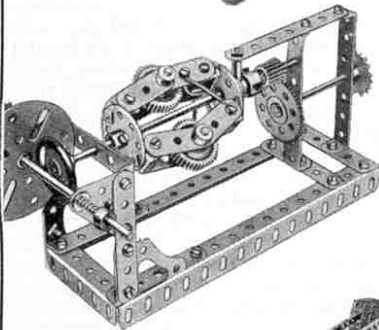

Automatic Infinitely Variable Speed Gear.

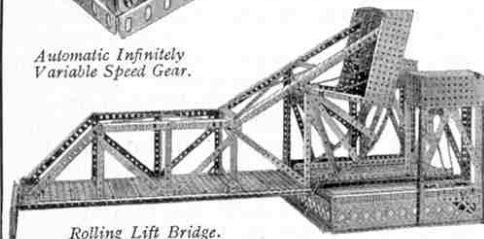

Rolling Lift Bridge.

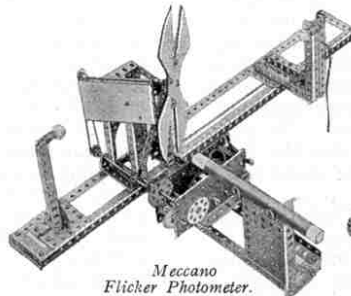

Meccano Flicker Photometer.

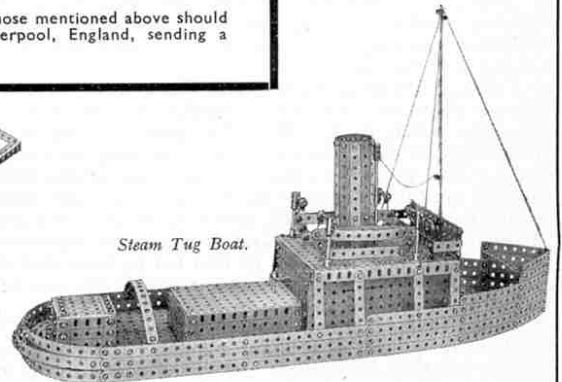

Steam Tug Boat.

MECCANO LIMITED

OLD SWAN

LIVERPOOL

# Boys, you MUST have this new Book



Get a  
copy  
to-day  
**PRICE**  
**9d.**

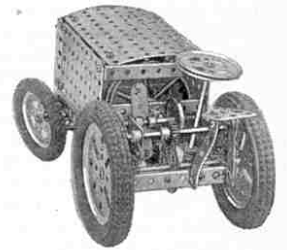

Novel Momentum Tractor.

### DO IT NOW!

We advise every keen Meccano boy to obtain his copy of the Book of New Models now, while supplies are available. The book contains illustrations and details of the best of the new models and new movements submitted in recent competitions, together with many others that have been designed by our own experts. All the models shown in the book are of outstanding interest and variety.

### HOW TO OBTAIN THE BOOK

The 1931 Book of New Models may be obtained from any Meccano dealer, price 9d., or direct from Meccano Ltd., Old Swan, Liverpool, price 10½d. post free.

There are special editions for Australia, New Zealand, South Africa and Canada and details of the prices of the book in these countries are as follows:—

**AUSTRALIA:** Price 2/- from dealers or 2/2 from E. G. Page & Co., 52, Clarence Street, Sydney. (P.O. Box 1832K).

**NEW ZEALAND:** Price 1/- from dealers or 1/2 from Models Ltd., P.O. Box 129, Auckland (Kingston Street).

**SOUTH AFRICA:** Price 1/- from dealers or 1/2 from Arthur E. Harris, 142, Market Street, Johannesburg. (P.O. Box 1199).

**CANADA:** Price 25 cents from dealers or 30 cents from Meccano Ltd., 34, St. Patrick Street, Toronto.

Readers living in countries other than those mentioned above should order from Meccano Ltd., Old Swan, Liverpool, England, sending a remittance of 1/2 with their orders.

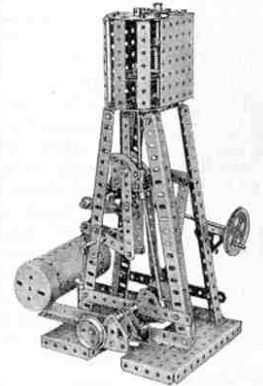

Single Cylinder Marine Engine.

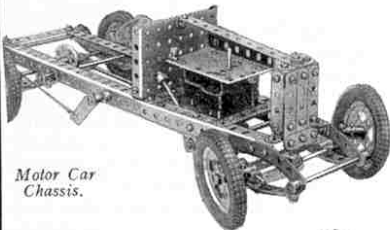

Motor Car Chassis.

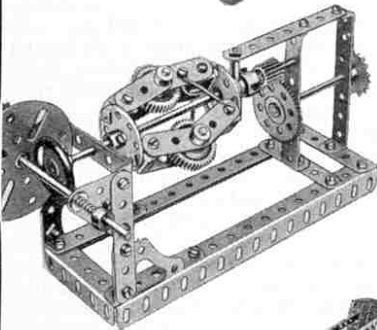

Automatic Infinitely Variable Speed Gear.

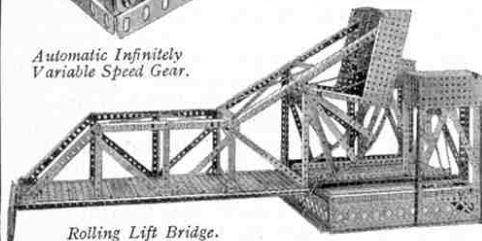

Rolling Lift Bridge.

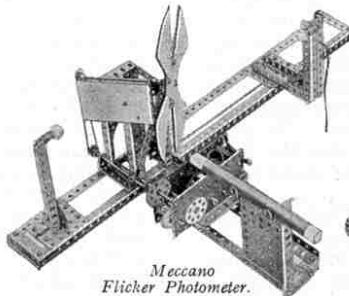

Meccano Flicker Photometer.

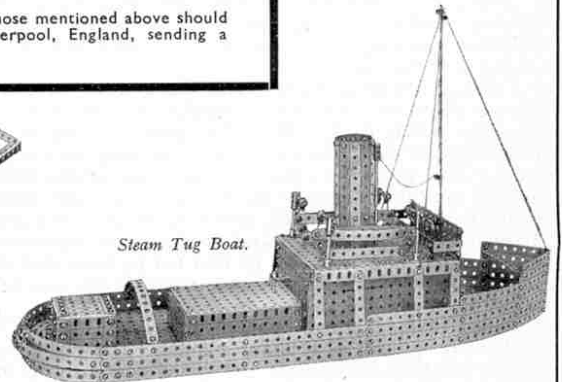

Steam Tug Boat.

MECCANO LIMITED

OLD SWAN

LIVERPOOL



# MECCANO

EXAMPLES OF MODEL CONSTRUCTION

## 1.—Transport by Road

LESS than 30 years ago practically all long-distance overland transport was carried by rail, and the appearance of a motor car was of sufficient novelty to attract a crowd of interested sightseers! To-day, one out of every twenty inhabitants of Great Britain owns a motor vehicle of some type, while all over the country the roads are thick with motor vehicles of every imaginable type, bent on business or pleasure.

The modern motor car represents the last word in engineering skill. It embodies a thousand marvels of mechanism, and its reliability is such that it has been used to carry man across hitherto unexplored deserts. Nevertheless, the newest and most elaborate motor vehicle conceals no secrets from the Meccano boy, for he is able to build up an exact replica of it in Meccano and thus keep abreast of latest developments. And in building his model he learns just how the gear box, differential, clutch, and other important mechanisms operate and why they are necessary.

Four excellent examples of models that may be classified under road transport are illustrated below. Other models in this branch of engineering that may also be built with Meccano include motor lorries, limousines, motor fire engines, road tractors, etc., and, of course, all kinds of motor accessories and garage equipment.

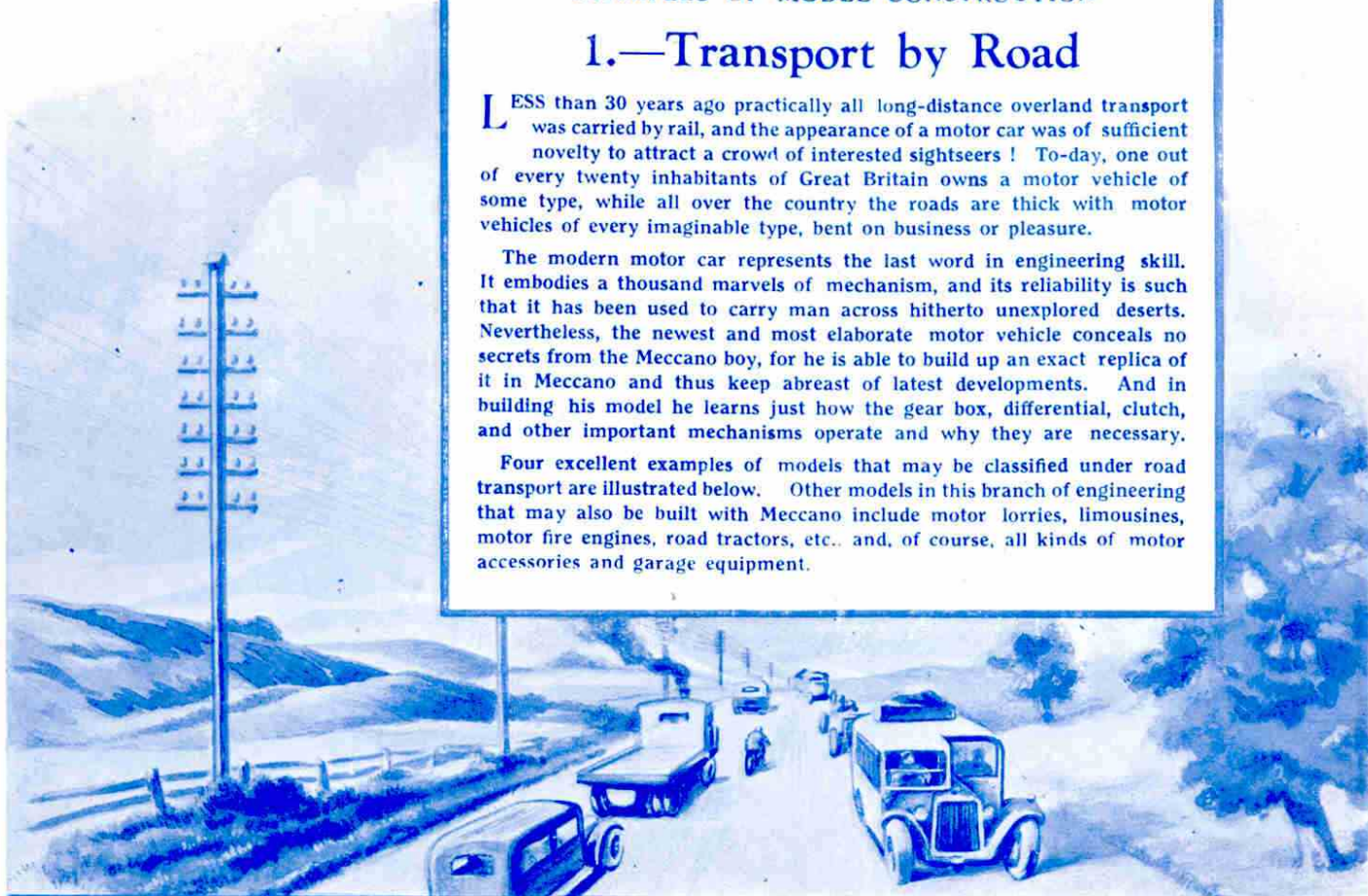

### MECCANO MOTOR CYCLE AND SIDECAR

The Meccano Motor Cycle (below) incorporates head and side lamps, sprung saddle, exhaust pipes, chain drive, Klaxon horn, luggage carrier, etc., while the sidecar, which is of graceful streamline design, is mounted on springs. The twin-cylinder engine is composed primarily of two Worms. See Instruction Leaflet No. 3 (Price 2d. post free).

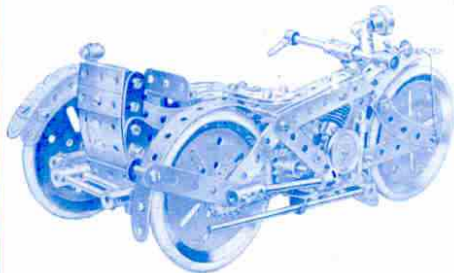

### MECCANO MOTOR CHASSIS

This model (right) is driven by a 6-volt Electric Motor and includes a gear box, clutch, differential, laminated springs, Ackermann steering, torque rods, etc. Full instructions for building the model are contained in Special Instruction Leaflet No. 1 (Price 3d. post free).

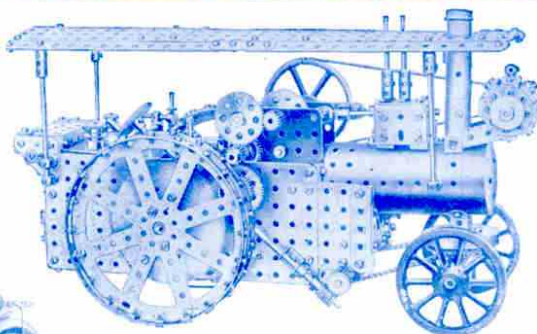

### MECCANO TRACTION ENGINE

Driven by a Meccano 6-volt Motor, which is mounted in the space occupied by the firebox in the prototype, the Traction Engine (left) will easily haul a boy of average weight. It is fitted with two-speeds forward and reverse controls, worm and chain steering gear, and brake. For detailed illustrations and complete instructions for building, see Special Instruction Leaflet No. 22 (Price 2d. post free).

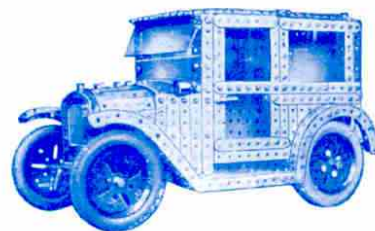

### MECCANO MOTOR CAR

The model shown above is of a "baby" car of a well-known make. It is built entirely from standard parts with the exception of the windscreen and windows. The model is complete with steering gear and if desired may be driven by a Meccano Clockwork or Electric Motor.

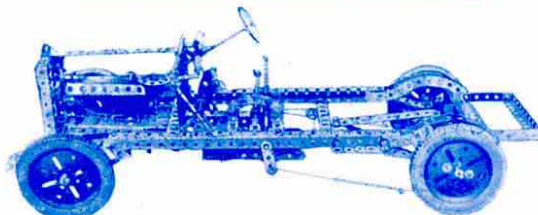

Meccano Outfits range in price from 2/6 to 450/-, and may be obtained from all leading toy stores. Ask to see them.

**MECCANO LTD.**  
Old Swan, LIVERPOOL



# MECCANO

EXAMPLES OF MODEL CONSTRUCTION

## 1.—Transport by Road

LESS than 30 years ago practically all long-distance overland transport was carried by rail, and the appearance of a motor car was of sufficient novelty to attract a crowd of interested sightseers! To-day, one out of every twenty inhabitants of Great Britain owns a motor vehicle of some type, while all over the country the roads are thick with motor vehicles of every imaginable type, bent on business or pleasure.

The modern motor car represents the last word in engineering skill. It embodies a thousand marvels of mechanism, and its reliability is such that it has been used to carry man across hitherto unexplored deserts. Nevertheless, the newest and most elaborate motor vehicle conceals no secrets from the Meccano boy, for he is able to build up an exact replica of it in Meccano and thus keep abreast of latest developments. And in building his model he learns just how the gear box, differential, clutch, and other important mechanisms operate and why they are necessary.

Four excellent examples of models that may be classified under road transport are illustrated below. Other models in this branch of engineering that may also be built with Meccano include motor lorries, limousines, motor fire engines, road tractors, etc., and, of course, all kinds of motor accessories and garage equipment.

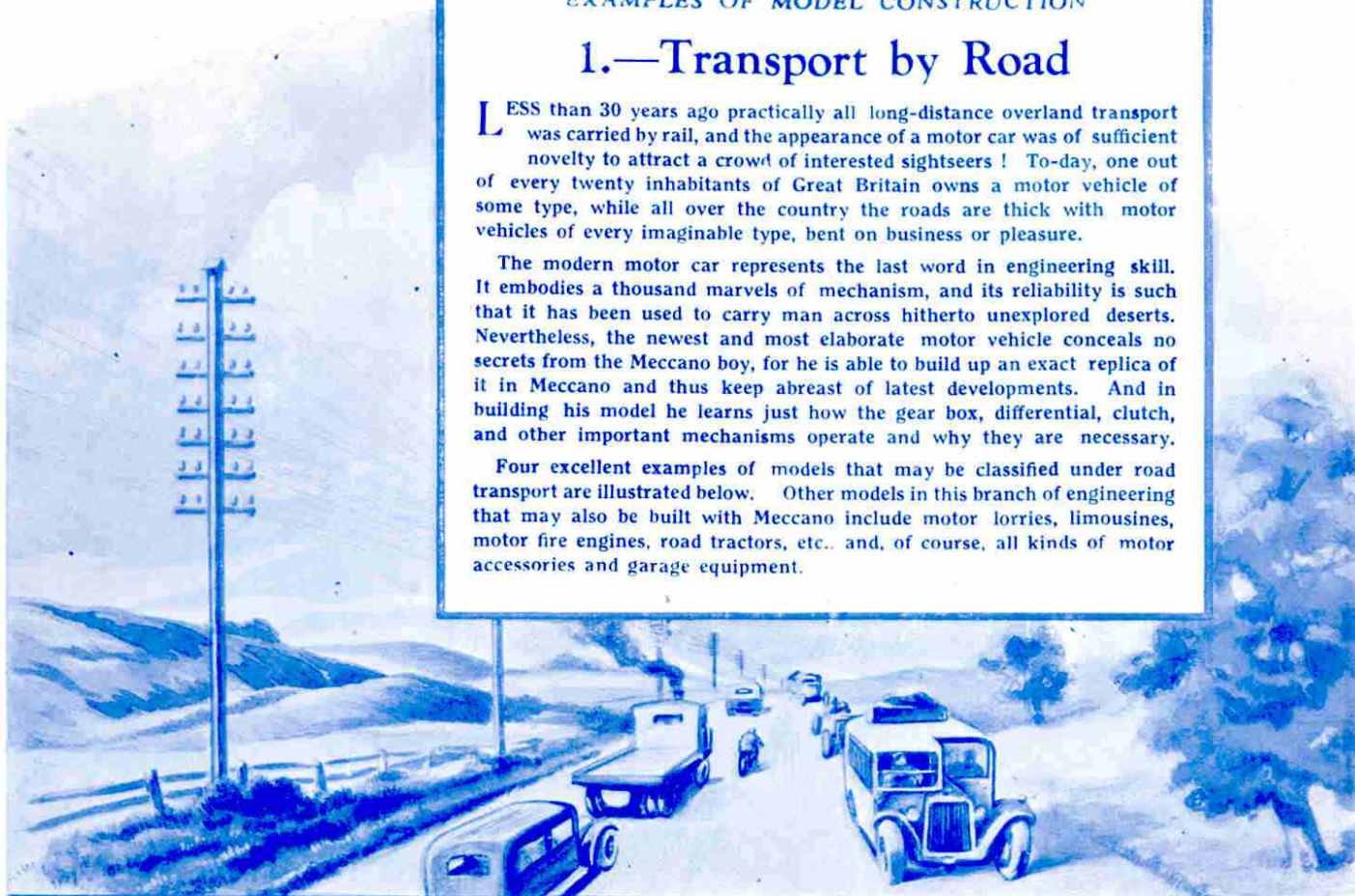

### MECCANO MOTOR CYCLE AND SIDECAR

The Meccano Motor Cycle (below) incorporates head and side lamps, sprung saddle, exhaust pipes, chain drive, Klaxon horn, luggage carrier, etc., while the sidecar, which is of graceful streamline design, is mounted on springs. The twin-cylinder engine is composed primarily of two Worms. See Instruction Leaflet No. 3 (Price 2d. post free).

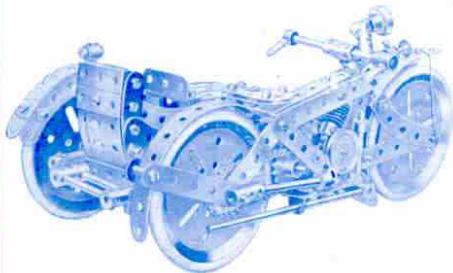

### MECCANO MOTOR CHASSIS

This model (right) is driven by a 6-volt Electric Motor and includes a gear box, clutch, differential, laminated springs, Ackermann steering, torque rods, etc. Full instructions for building the model are contained in Special Instruction Leaflet No. 1 (Price 3d. post free).

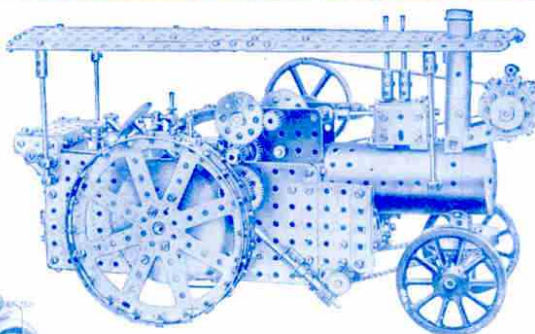

### MECCANO TRACTION ENGINE

Driven by a Meccano 6-volt Motor, which is mounted in the space occupied by the firebox in the prototype, the Traction Engine (left) will easily haul a boy of average weight. It is fitted with two-speeds forward and reverse controls, worm and chain steering gear, and brake. For detailed illustrations and complete instructions for building, see Special Instruction Leaflet No. 22 (Price 2d. post free).

Meccano Outfits range in price from 2/6 to 450/-, and may be obtained from all leading toy stores. Ask to see them.

**MECCANO LTD.**  
Old Swan, LIVERPOOL

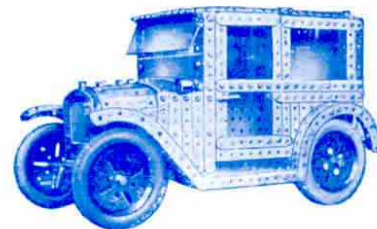

### MECCANO MOTOR CAR

The model shown above is of a "baby" car of a well-known make. It is built entirely from standard parts with the exception of the windscreen and windows. The model is complete with steering gear and if desired may be driven by a Meccano Clockwork or Electric Motor.





# Model-Building Contests Results

By Frank Hornby

## "August" Competition: Section "A"

THE entry in the "August" Model-building Contest was so large that I have decided to deal separately with each of the three Sections (A, B and C) into which it was divided. This month therefore I am announcing the prize-winners in Section A. The results in Section B will be published next month, and the Overseas Section will then be dealt with.

Examples of the many fine models received in Section A are illustrated on this and the opposite page, and the full list of prize-winners is as follows:—

**Section A** (for Home competitors over 14 years of age).

**FIRST PRIZE**, Cheque for £3-3s.: S. Croft Grey, Edinburgh. **SECOND PRIZE**, Cheque for £2-2s.: Eric Whalley, Blackburn, Lancs. **THIRD PRIZE**, Cheque for £1-1s.: Kenneth Brookes, Leek, Staffs.

**SIX PRIZES** of solid leather Pocket Wallets: J. Brown, London, S.W.19; D. Young, West Croydon, Surrey; L. Richardson, London, N.7; M. Powley, Sunderland; R. Morison, Cambridge; A. McKerrell and I. Morton (joint entry), Midlothian, Scotland.

**TWELVE PRIZES** of Meccano or Hornby Train goods value 5/-: A. Farr, Costessey, Nr. Norwich; L. Frayn, Plymouth; J. Matthews, Fillongley, Nr. Coventry; L. Balchin, Dunstable, Beds.; H. Wrathall, Blundellsands, Liverpool; J. Waterkeyn, Spinkhill, Nr. Sheffield; J. Morrison, Newlands, Glasgow, S.3; W. Malcolm, Edinburgh; R. Lawford, Bexley Heath, Kent; C. Percivall, Basingstoke, Hants.; L. Willis, London, S.E.9; R. Lamont, Greenock.

**PRIZES** of Meccano Engineer's Pocket Books: E. Deakin, Leicester; E. Hines, Addiscombe, Surrey; F. Drane, London, S.W.18; A. Armstrong, Fernhurst, Sussex; J. Kernkert, Esher, Surrey; S. Herbert, London, S.E.15; H. Kendrick, Walsall; M. Barraclough, Bournemouth; K. Heath, Wellington College, Berks.; P. Woodman, Streatham Rise, Exeter; J. Whittle, Wigan; J. McDonald, Yeovil, Somerset; H. Hill, Sheffield; S. Pearson, Haltwhistle, Northumberland; G. Moore, London, E.3; J. Holmes, Wishaw; J. Williams, Two Dales, Nr. Matlock, Derbys.; J. Powell, St. Ives, Hunts.; J. Winder, Darwen; D. Conington, Huntingdon, Hunts.; N. Bird, Hull; H. Brown, G. Waldron and R. Waldron (joint entry), Combe Down, Bath; R. Marshall, Cardiff; P. Rankin, Banbury, Oxon; T. Lloyd, Midhurst, Sussex; T. Kennett, London, W.; J. Cunningham, Burnbank, Lanarkshire; R. Harkness, Braintree, Essex; L. Jones, Cardiff; T. Baker, Taunton, Somerset; K. Batchelor, Dorking, Surrey; R. Lawler, Glossop; W. Raybould, Bloxwich, Staffs.; W. Lansbury, Banbury, Oxon; R. Nightingale, Langley, Nr. Birmingham; M. Young, Purley, Surrey; B. Simpson, London, S.W.5; N. Southgate, Stow Market, Suffolk; S. Davidge, London, N.16.

**CERTIFICATE OF MERIT**: R. Mason, Newcastle, Staffs.; C. Marston, Halifax; G. Smith, Acomb, York; A. Baldwin, Sunderland; S. Coleman, London, W.10; W. Huxley, Market Drayton, Shrops.; D. Goligher, Chesham Bois, Bucks.; K. Coppin, Swindon; T. Ryan, Cahirciveen, Co. Kerry, Ireland; F. Roberts, Plymouth, Devon; F. Clark, Canterbury; D. Longman, Leeds; C. Rollings, Hounslow, Middx.; H. Bourne, Scunthorpe, Lincs.; R. McKeand, Portpatrick, Wigtonshire; W. Clement, Willington, Co. Durham; E. Hodgson, Carlisle; H. Lewis, Pontypool, Mon.; L. Libaert, Cheam, Surrey; C. Hitchcock, Burnham-on-Sea; J. Orwin, Tuebrook, Liverpool; S. Downes, Farncombe, Surrey; A. Williams, Cardiff; V. Kaile, Mayford, Nr. Woking; C. Dell, Orpington, Kent; A. Reveley, Bridlington; E. Luck, Ashton-under-Lyne; D. Morgan, Bromley, Kent; R. Boyd, London, S.E.3.

First Prize was awarded for the fine L.N.E.R. 4-4-0 "Shire" class locomotive shown here. This model is one of the best I have seen recently, and incorporates a complete working replica of Walschaerts valve gear, with Gresley combining motion for the inside cylinder, the engine being of the three-cylinder type. The valve gear is operated by screw mechanism from the cab.

Special details include a balanced crank, dummy brakes and spring gear for the driving wheels, and a mechanical lubricator worked from a rocking shaft that is operated by the inside cross-head as in the original.

The model is driven by an Electric Motor hidden in the tender and controlled by a Resistance Controller. The photograph reproduced shows a number of other details that have been well worked out in standard Meccano parts.

Eric Whalley has every reason to be proud of his fine model of a Leyland motor chassis that won Second Prize in this Contest. The model is driven by two Electric Motors and has a single plate clutch and a three-speed and reverse gear-box with "ball and gate" change. The propeller shaft is constructed from two Angle Girders. There are two "live" rear axles, and the wheels are fitted with internal expanding brakes, with two semi-circular shoes in each brake drum.

The side members of the chassis are built-up channel girders made rigid by cross members, the length of the chassis being 3' 2" and the width 5½".

The side members are bent so as to keep the chassis level over the rear bogie. The drive transmission to the clutch is at a ratio of 6:1, and the clutch is constructed similarly to that used in the Meccano Super Model Motor Chassis (Instruction Leaflet No. 1).

The gear-box provides three speeds forward and one reverse, the various gears being selected by a central gear-changing lever of the "ball and gate" pattern. The "gate" is made in the form of a letter H, and

A miniature saloon motor car, by James W. Brown, London, S.W.19. A surprising amount of detail work is shown, including a sliding "sunshine" roof.

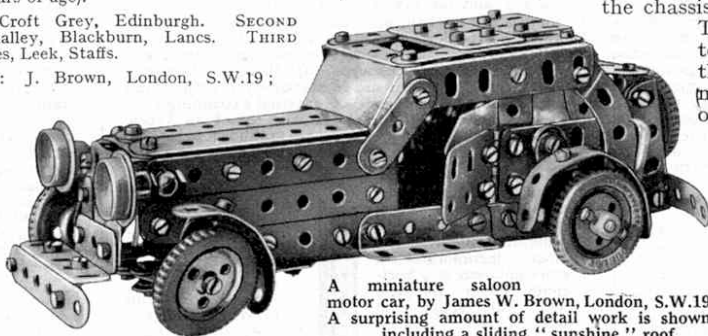

enables the gears to be located accurately. The "H" was made from two 2" slotted Strips (part No. 55a) placed side by side, and a small piece cut out to form the connecting slot. The gear-box is attractively arranged between two Face Plates as shown in the accompanying illustration.

The differential mechanism is arranged inside a special crown wheel that is formed from a 5½" Rack Strip bent into a circle, with one hole overlap. Three ¾" Bevels are mounted on Threaded Pins, which project towards the centre and are placed at an angle of 120 degrees to each other. Two other Bevel Gears are put against these, one being fastened to each half of the axle. At the rear end of the propeller shaft is a ½" Pinion that meshes with the teeth of the crown wheel. This arrangement is repeated for both axles.

The propeller shaft between the two rear axles is constructed from the new Flexible Coupling Units, which take the twists and tensions of the rear bogie when driving over rough ground.

To form the steering gear, a Bolt is passed through the centre holes of the front spring leaves and is tightened into the tapped hole of a Collar. A Crank Handle is secured in this Collar, the "handle" part of the Crank Handle being cut off to leave a length of ½", which is then inserted in the centre hole of a Coupling.

A Bush Wheel has two Collars bolted to its face side through their tapped holes, and a Coupling rides between them, being held in position by ¾" Bolts passed through the Collars into the Coupling. The track rod and link are held loosely to a bracket projecting from the face of the Bush Wheel. Both ends of the axle are made alike, and it is supported at its centre in a Coupling. A small Flanged Wheel is used to represent the device for quick changing of wheels and is held on the outer end of the stub axles.

The petrol tank is constructed from two Boilers placed horizontally end to end

on the left-hand side of the chassis, and a pipe (Axle Rod) leads from the tank to the autovac, which is on the right-hand side of the engine and is made from a Sleeve Piece capped at each end with small Flanged Wheels.

A few years ago there was quite an epidemic of Meccano models of motor-cycles, but in recent contests such models have been scarce. It is therefore quite a change to find the Third Prize in the "August" Competition won by Kenneth Brookes with the model

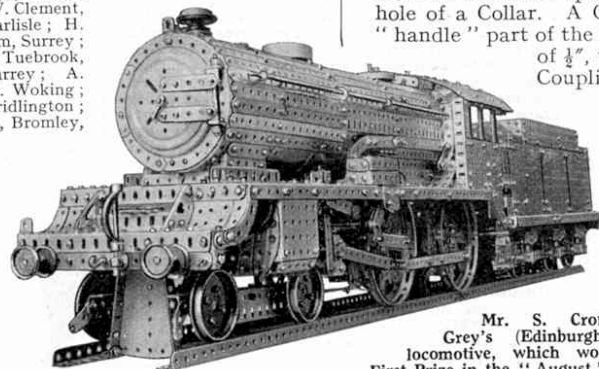

Mr. S. Croft Grey's (Edinburgh) locomotive, which won First Prize in the "August" Competition.