

# ELECTRICITY

*A series of Splendid Articles  
Specially written for Meccano Boys*

## V. MAGNETS AND MAGNETISM

IN certain parts of the world there exists a peculiar kind of iron ore which has the power of attracting iron. If a piece of this ore be suspended so that it swings freely it will always turn to the north. This ore is called "lodestone," and its strange power is due to what is called "magnetism."

The origin of the name magnetism is uncertain, but according to one old story a shepherd named Magnes, who lived in Asia Minor, was one day tending his sheep on a mountain side and happened to touch with the iron tip of his crook a piece of dark-coloured rock. To his great astonishment he found that the rock held his crook so firmly that he could scarcely pull it away. This rock was formed of lodestone, and the name magnetism is said to have come from the shepherd's name, Magnes. Another explanation is that the name is derived from Magnesia, also in Asia Minor, where lodestone is found in large quantities. The name lodestone itself comes from the Saxon word *laeden*, which means "to lead," and refers to the lodestone's power of always pointing to the north if free to do so.

### Artificial Magnets

Lodestone is a natural magnet. We can make artificial magnets out of pieces of steel by rubbing them with a piece of lodestone, and these magnets attract iron and turn to the north exactly as lodestone does. A piece of iron may be magnetised in the same way, but there is a very important difference to be noted—iron quickly loses its magnetism, whereas steel retains it. The softer the iron the quicker it loses its magnetism, and the harder the steel the better it retains its magnetism. Consequently, a specially hard quality of steel is used for making artificial magnets, but nowadays such magnets are not made by rubbing them with lodestone, but by means of an electric current, as we shall see later. Magnets are made either in the form of a straight bar or of a horseshoe, as illustrated in the diagram on the next page.

### Some Interesting Experiments

A number of very interesting experiments may be made with two bar magnets and a small quantity of iron filings. If we roll a bar magnet among iron filings we

find that the filings do not cling to it equally all over, but cluster thickly at each end of the magnet, few or none clinging to the middle. These two points, at which the magnet attracts iron most strongly, are called the "poles" of the magnet.

Magnetism, the subject of this article, plays a very important part in the operation of electrical mechanism of nearly every kind. We recommend our readers to carefully follow the explanation of the subject, for without some knowledge of the principles of magnetism it is impossible to understand the working of dynamos, motors, electric bells, and a host of other machines and appliances.

If we suspend a bar magnet from its centre by means of a sort of stirrup of copper wire attached to a thread, it will take up a position pointing north and south. The end which points to the north is called the "north pole" of the magnet and the other end the "south pole." The north pole of a magnet is usually marked with the letter N, or in some other way. If we bring each end of another magnet in turn near each end of the suspended magnet, we find that the two north poles or the two south poles repel one another, but that a north pole attracts a south pole, and vice versa.

These experiments show us that both poles of a magnet attract unmagnetised

like" and "unlikes attracted."

For experimental purposes it is useful to have a number of small magnets, and these are easily made out of steel knitting - needles or sewing - needles. Place the needle on the table and draw one pole of a bar magnet along it from end to end several times, always starting at the same end of the needle, and lifting the magnet quite clear of the needle at the end of each stroke.

### Magnetic Induction

A piece of soft iron may be magnetised by a magnet without actual contact, by what is called "magnetic induction." Place a short piece of soft iron on the table close to some iron filings. Then bring one end of a bar magnet near one end of the iron, and the iron will immediately attract the filings, showing that it is now magnetised. As soon as the magnet is taken away the piece of iron loses its power to attract filings, showing that its magnetism has gone. It is very interesting to repeat this experiment with a sheet of glass, paper, or wood between the magnet and the piece of iron. These substances do not interfere in the least with the action of the magnet, but if a sheet of iron is used the experiment will not work, for iron has the power to "screen" or prevent the action of magnetism.

### Invisible Lines of Force

Spread a thin layer of iron filings over a sheet of cardboard, and watch the result when a magnet is moved to and fro just beneath the sheet. The effect is very amusing. The filings stand up when the magnet approaches them, and follow it about as if pulled by invisible strings. As a matter of fact, the magnet really does act by means of invisible strings, which are known as "lines of force." These lines of force proceed from the magnet in certain definite directions, and although invisible in themselves, we are able to see them at work, as it were, in a most fascinating manner.

Place a magnet underneath a sheet of glass and sprinkle iron filings thinly and evenly over the glass. The best way of handling the filings is to put them into a little muslin bag and shake the bag gently. Then tap the sheet of glass very lightly with a pencil and the filings

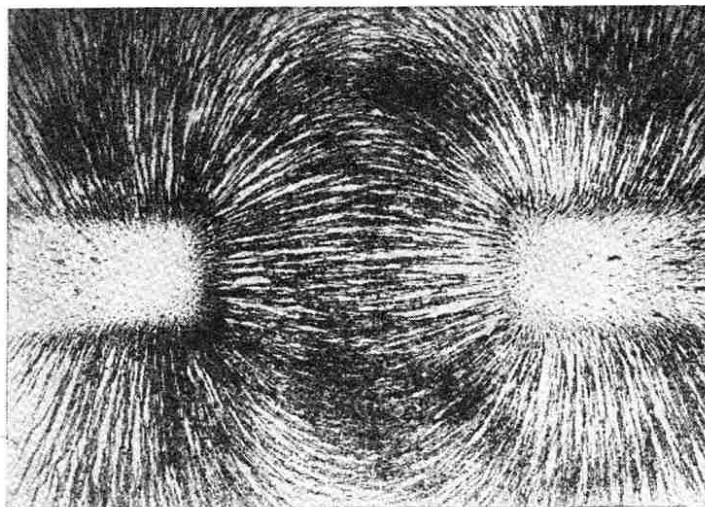

Lines of Force of Two Opposite Poles

iron, but that similar poles of two magnets repel one another and opposite poles attract one another. Our readers will remember that this is exactly what happened in our earlier experiments with the charged glass rods, when "like repelled

will immediately arrange themselves in a most wonderful manner. The filings become magnetised by induction, and when the gentle tap frees them for an instant from the friction of the glass they take up certain positions, according to the direction of the magnetic force acting on them. In this way we obtain a map showing the general direction of the lines of magnetic force.

By using different combinations of magnets a great many different maps may be made in this way. The illustration on page 176 shows the lines of force of two opposite poles of two bar magnets, and it will be seen that the lines appear to stream across from one pole to the other. The illustration on this page shows the lines of force of two similar poles, and in this case it is very remarkable how the lines from the two poles turn aside as if pushing each other away. Equally interesting maps can be made with a horseshoe magnet.

#### Keepers for Magnets

Magnets left with their poles unprotected gradually lose their magnetism. For this reason a horseshoe magnet has its two poles connected by a piece of soft iron, and bar magnets are usually kept in pairs, with a strip of wood separating them, their opposite poles being together, and across the ends a piece of soft iron, called a "keeper" (see diagram below).

It is necessary to remember that magnets lose a great deal of their magnetism if they are knocked or allowed to fall. Allowing the keeper to slam on to a magnet is also injurious, but pulling off the keeper vigorously is good for the magnet.

#### Magnetic Dip

Let us now magnetise a needle and suspend it by a thread so that it is free to swing either horizontally or vertically. We notice that it not only comes to rest in a north and south direction, but also tilts slightly with its north end downwards. If we could take our needle to some place south of the equator, it would still point north and south, but it would tilt with its south end downwards. The angle that the tilting needle makes with the horizontal is called the "magnetic dip."

#### The Earth a Great Magnet

The explanation as to why a suspended magnet always takes up a position pointing north and south was found by Dr. Gilbert, of Colchester, physician to Queen Elizabeth. In the year 1600 he announced his great discovery that the earth itself is a huge magnet, having its poles near to the geographical north and south poles.

We have seen that similar magnetic poles repel one another, and yet the north pole of a magnet turns towards the north magnetic pole of the earth. Evidently, in order to get this attraction, one of these poles must really be a south pole, and it is customary to regard the earth's north magnetic pole as possessing south magnetism, and the south magnetic pole as possessing north magnetism. So we may look upon the north-pointing pole of a magnet as a true north pole, and the south-pointing pole as a true south pole.

The earth's magnetic influence also accounts for magnetic dip. North of the equator, in England for instance, the north magnetic pole of the earth is nearer than the south magnetic pole. Thus its influence is stronger, and a freely suspended magnet dips downwards towards the north. If we take our magnet to a

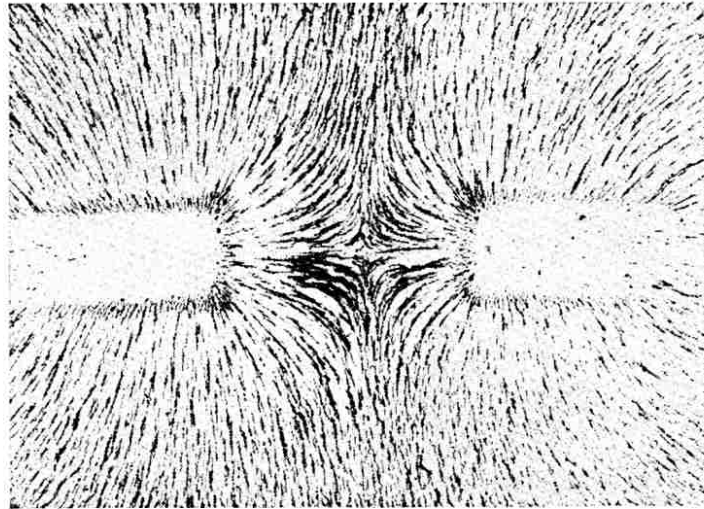

Lines of Force of Two Similar Poles

place where the earth's south magnetic pole is the nearer, the magnet will dip downwards towards the south. Could we place our suspended magnet immediately over either of the earth's magnetic poles, it would take up a vertical position; and at the earth's magnetic equator, where the influence of the two poles is equal, the magnet would not dip at all.

#### The Mariner's Compass

The most valuable application of the peculiarity of a magnet pointing north and south is in the compass. We are all familiar with the ordinary pocket compass, consisting simply of a magnetised needle, pivoted so as to swing freely over a card marked with the 32 points of the compass.

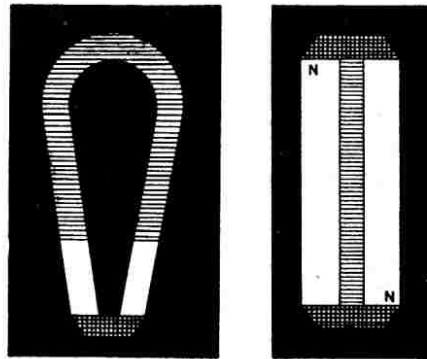

Horseshoe and Pair of bar magnets

For use on ships, however, a much more elaborate arrangement is necessary. The single needle of the land compass is replaced by a compound needle consisting of several thin strips of steel, magnetised separately, and suspended side by side. Such a needle is infinitely more reliable than a single needle.

The needle and the compass card are placed in a kind of bowl made of copper. In order to keep this bowl in a horizontal position, no matter how the ship may be rolling, it is supported on "gimbals"

consisting of two concentric rings attached to horizontal pivots and moving in axes at right angles to one another. There are also liquid compasses, in which the card floats on the surface of dilute alcohol.

The earth's magnetic poles do not coincide with the geographical poles, and, therefore, a compass needle seldom points exactly north and south. The angle between the magnetic meridian and the geographical meridian is called the "declination," and—as Columbus discovered in 1492—this varies in different parts of the world. In order that navigators may know the exact declination at any part of the world, special magnetic maps are made in which all places having the same declination are joined by a line.

#### Electric Current and Magnetised Needle

We have already mentioned that artificial magnets are made by means of an electric current, and now we must explain how this is done. If we take a freely-swinging magnetised needle, such as a compass needle, and hold over it a copper wire, nothing happens; but if we send an

electric current through the wire, the needle is at once turned to one side, or deflected. As soon as the current is stopped, the needle returns to its north and south position. Further, iron filings cling to the wire while the current is flowing, but drop off when the current is stopped. These facts show us that the wire becomes a magnet during the passage of the current, and loses its magnetism when the current ceases. A spiral of insulated wire through which a current is flowing shows all the powers of a magnet, and, in addition, it has the peculiar power of drawing or sucking into its interior a rod of iron. Such a spiral is called a "solenoid," and will be familiar to those of our readers who possess a Meccano Electrical Outfit.

#### Electro-Magnets

If we wind a number of turns of insulated wire round a rod of soft iron, and pass a current through the wire, the rod becomes a magnet, but loses its magnetism when the current stops. A magnet made in this way—that is, by the passage of an electric current—is called an "electro-magnet," and it has all the power of an ordinary steel magnet, but in a very much greater degree. In subsequent articles we shall describe some of the many industrial applications of powerful electro-magnets.

If we substitute a bar of steel for the iron, it becomes magnetised by the current in the same way, but, unlike the iron, it retains its magnetism after the current ceases. This enables us to make steel magnets of much greater strength than those produced by rubbing with another magnet. Such steel magnets are called "permanent magnets," for they retain their magnetism; whereas electro-magnets, in which soft iron is used, only possess magnetism as long as the current flows.

#### Detecting and Measuring Electric Currents

The deflection of a magnetised needle by a current of electricity provides us

(Continued on page 179)



# A NEW MECCANO MODEL

Model No. 629

## RADIAL TRAVELLING CRANE

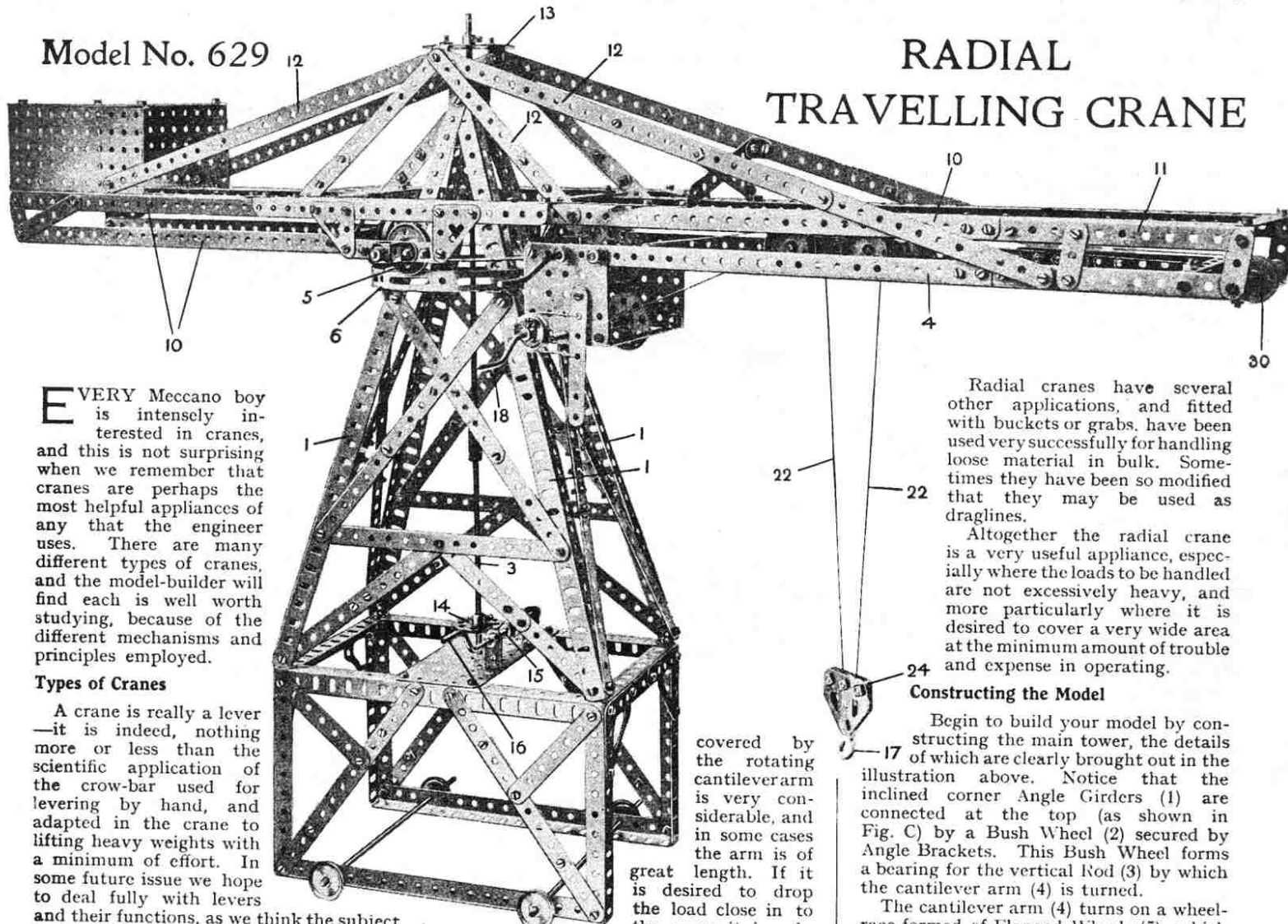

EVERY Meccano boy is intensely interested in cranes, and this is not surprising when we remember that cranes are perhaps the most helpful appliances of any that the engineer uses. There are many different types of cranes, and the model-builder will find each is well worth studying, because of the different mechanisms and principles employed.

### Types of Cranes

A crane is really a lever—it is indeed, nothing more or less than the scientific application of the crow-bar used for levering by hand, and adapted in the crane to lifting heavy weights with a minimum of effort. In some future issue we hope to deal fully with levers and their functions, as we think the subject will be of general interest to our readers.

Different requirements necessitate special cranes, each designed so as to be most serviceable under the special conditions imposed. There is, for instance, the comparatively small dock-side crane that runs astride the wharf and does not require a great deal of leg-room. Where space is not so important the base of the crane can be designed differently, which is fortunate, for a large base is necessary to give stability in the case of the hammer-head cranes used in our ship-building yards. These giant cranes lift boilers or big guns into position with the greatest ease.

### Radial Travelling Cranes

Our new model, which we here illustrate and describe, is a Radial Travelling Crane of the cantilever type. This type of crane is used on the Panama Railways at the docks for handling freight. They stand well back from the quay-side, lift their load from the hold of the ship and then swing round and dump the load on the ground behind the docks.

Radial cranes are also used extensively in iron and steel yards and in timber yards, where it is necessary to drop loads over a large area. The ground

covered by the rotating cantilever arm is very considerable, and in some cases the arm is of great length. If it is desired to drop the load close in to the crane it is only

necessary to run the travelling bogie inwards along the arm. This enables the load to be dropped at any point between the base of the crane and the end of the arm, and anywhere within the circle through which the arm may be moved.

### Other Applications

A modified form of the radial crane is used in ship-building, and mounted on steel trestles alongside the vessel that is being built. In these cases the cranes move on wheels which run on a track laid on the steel trestles.

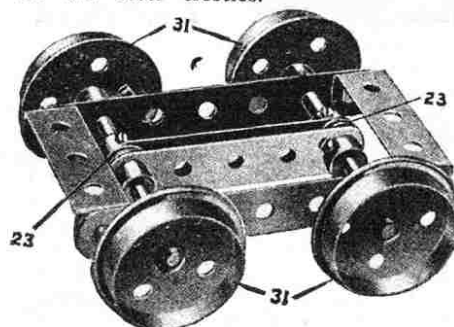

Fig. A. Trolley

Radial cranes have several other applications, and fitted with buckets or grabs, have been used very successfully for handling loose material in bulk. Sometimes they have been so modified that they may be used as draglines.

Altogether the radial crane is a very useful appliance, especially where the loads to be handled are not excessively heavy, and more particularly where it is desired to cover a very wide area at the minimum amount of trouble and expense in operating.

### Constructing the Model

Begin to build your model by constructing the main tower, the details of which are clearly brought out in the illustration above. Notice that the inclined corner Angle Girders (1) are connected at the top (as shown in Fig. C) by a Bush Wheel (2) secured by Angle Brackets. This Bush Wheel forms a bearing for the vertical Rod (3) by which the cantilever arm (4) is turned.

The cantilever arm (4) turns on a wheel-race formed of Flanged Wheels (5), which run on a Circular Girder\* (6) supported by four  $1\frac{1}{2} \times \frac{1}{2}$ " Angle Brackets (7) bolted to the corner Girders (1). The cantilever is built up (as shown in Fig. B) from two  $9\frac{1}{2}$ " Angle Girders (8) braced by two  $5\frac{1}{2}$ " Angle Girders (9) overlapped nine holes. From these,  $12\frac{1}{2}$ " Angle Girders (10) extend at one side, and to similar Girders (11) at the other side are connected  $5\frac{1}{2}$ " Girders (11).

### Rotating the Arm

The inclined Strips (12) are connected at the top, by means of Angle Brackets, to a Face Plate (13) secured to the vertical Rod (3). At the foot of the Rod (3) is a  $1\frac{1}{2}$ " Gear Wheel (14) engaged by a Worm Wheel (15) operated by the Crank Handle (16) and in this way the cantilever arm is swung round, the wheels (5) riding on the Circular Girder (6).

The load carried from the Hook (17) is raised or lowered by the Crank Handle (18), a  $\frac{1}{2}$ " Pinion (19) on which engages a  $1\frac{1}{2}$ " Gear Wheel (20) on a Rod (21) on which is wound a Cord (22). This Cord passes over a  $\frac{1}{2}$ " Pulley (23) to the block (24) and back over another  $\frac{1}{2}$ " Pulley on the trolley, and is secured to the  $3\frac{1}{2} \times \frac{1}{2}$ " Double Angle Strip (25) at the outer end of the cantilever arm.

\* The Circular Girder, No. 143, is a new part, which is announced on page 195.

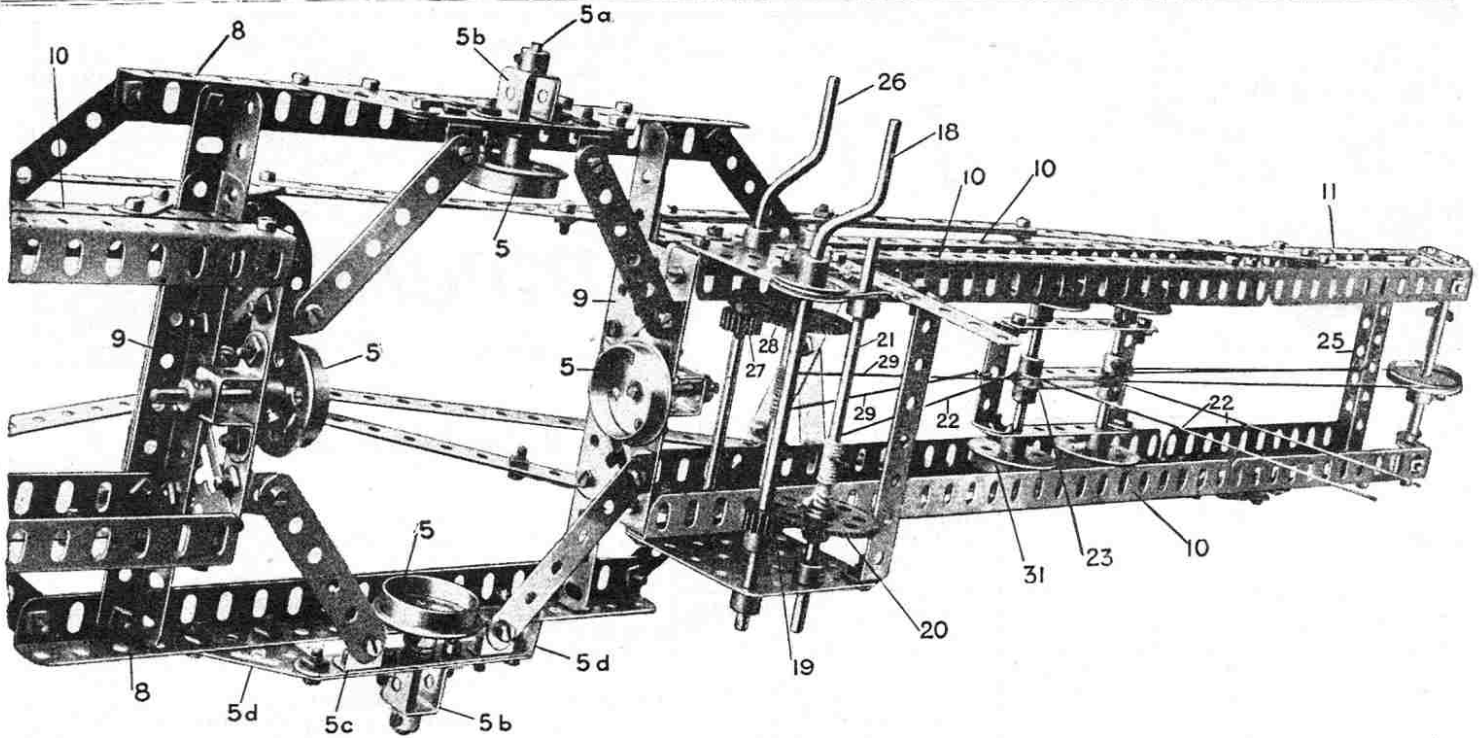

Fig. B. Details of the Cantilever Arm

Consequently, when the trolley is caused to travel along the cantilever arm the load remains suspended at a constant height—an important point and an interesting detail.

**The Movement of the Trolley**

The trolley is caused to move to and fro along the cantilever arm by the action of the Crank Handle (26). On this a  $\frac{1}{2}$ " Pinion (27) engages a  $1\frac{1}{2}$ " Gear Wheel (28) on a rod on which is wound the Cord (29), the opposite ends of which are connected to the opposite ends of the trolley. The Cord (29) passes round a Pulley (30) at the outer end of the jib. By turning the Crank Handle (26), therefore, the Cord (29) winds on and off its rod, and moves the trolley to and fro, its Wheels (31), as shown in Fig. A, running on the Angle Girders (10).

The Wheels (5) are connected to  $1\frac{1}{2}$ " Rods (5a) which are journalled in Double Bent Strips (5b) bolted to  $3\frac{1}{2}$ " Strips (5c) carried from the Angle Girders (8) by Corner Brackets (5d).

Parts required:—

6 of No. 1	1 of No. 24
2 " " 1b	2 " " 26
28 " " 2a	3 " " 27a
23 " " 3	1 " " 32
18 " " 4	2 " " 35
2 " " 5	292 " " 37
8 " " 6	61 " " 37a
6 " " 6a	10 " " 38
12 " " 7	1 " " 40
6 " " 8a	4 " " 45
18 " " 9	1 " " 46
22 " " 12	2 " " 48
4 " " 12b	4 " " 48b
1 " " 13	2 " " 52
2 " " 13a	1 " " 52a
1 " " 14	1 " " 53a
1 " " 15	1 " " 57
1 " " 15a	19 " " 59
3 " " 16	1 " " 63
2 " " 16b	2 " " 72
4 " " 18a	4 " " 108
3 " " 19	1 " " 109
8 " " 20	60 " " 111b
5 " " 22	1 " " 118
3 " " 23	2 " " 126

8 of No. 133

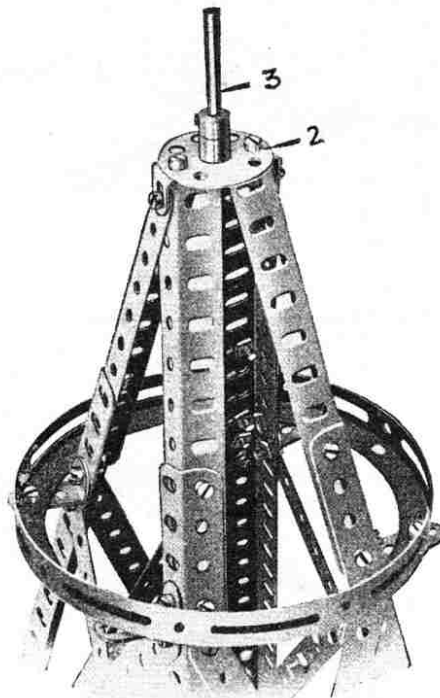

Fig. C. Details of Top of Main Tower

**How to Build the Meccano Chassis**

The Meccano Chassis is a triumph of model-building. At the British Industries Fair it attracted the attention of H.M. the King and was the centre of marked interest to thousands of other visitors to the Meccano exhibit. Fitted with three-speed gear box (with reverse) differential gear, elliptical springing and other modern refinements, the Chassis is an accurate reproduction of the "real thing." So perfectly does it illustrate the main mechanical features of a modern motor car that it is in use at several schools of motoring for demonstration purposes. Full instructions for building this Chassis in miniature are contained in the special leaflet now ready price 4d. post free.

**Electricity** (continued from page 177)

with a simple means of detecting such a current. An instrument called a "galvanometer" is used for this purpose, and in its simplest form it consists of a magnetic needle, very delicately poised, surrounded by a coil of many turns of wire. The effect of the coil is to make the current pass many times round the needle, and this increases the amount of deflection.

If we make a galvanometer with a long coil of very thin wire, having a high resistance, the amount of current flowing through it will depend upon and be proportional to the electro-motive force. Such an instrument, if properly graduated, will measure the voltage of the current, and is called a "voltmeter." On the other hand, if we provide our galvanometer with a short coil of very thick wire the resistance will be practically nil, and by means of a graduated scale the amount of current flowing—that is, the number of amperes—may be measured. An instrument of this kind is called an "ammeter," or "ammeter."

These three instruments, as described, are the very simplest types, and in actual scientific and engineering work more elaborate forms are used to obtain greater accuracy and sensitiveness.

**NEXT MONTH:—**  
**DYNAMOS AND MOTORS**

**£5 for a Model Dragline**

We would remind our readers of the novel Model-Building Competition in which prizes of £5 (cash) and £5 5s. 0d. (goods) are being offered for the best model of a Dragline. Full particulars were announced on page 164 of the June "M.M." Closing date 30th September next.