

Meccano Constructors Guide

A new series dealing
with gadgets and
mechanisms that
will be useful to
Meccano modellers

By B. N. Love

Part 1—Basic Construction

THERE IS no doubt that Meccano Parts make up the most versatile and comprehensive construction system in the world and one which has maintained its lead in a competitive field ever since its inception by Frank Hornby in 1901, when he marketed his first comparatively crude "Mechanics Made Easy" outfits in little tin boxes. With remarkable foresight, the

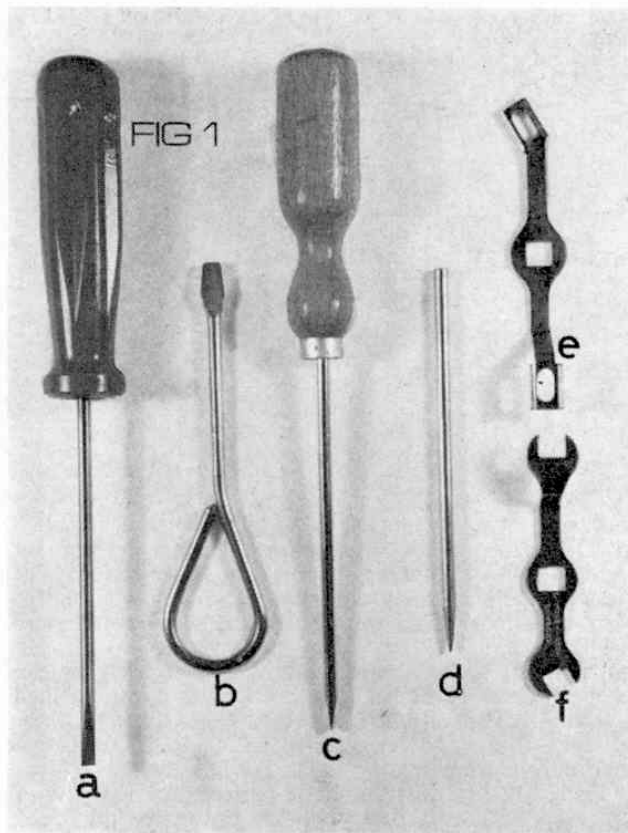
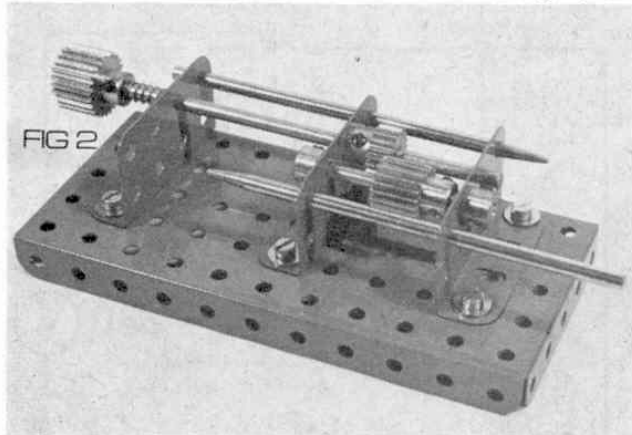

creator of Meccano adopted a standardisation of parts and perforations on which the system has developed over a period of three generations. The greatest appeal in using Meccano stems from the fact that no special tools are required to construct even the most complex and advanced models, the basic items being a screwdriver and a spanner. However, even in the use of simple tools, there is a right and a wrong way of employing them and this opening article of what will be a twelve-part series, gives some hints and guidance for the benefit of all who enjoy this wonderful hobby the world over.

Nuts and Bolts, Part Nos. 37a and 37b respectively, are the basic fasteners for the whole system and these are manufactured literally by the million in the high speed ultra-modern machines in the Meccano factory at Liverpool and they follow a standard Whitworth pattern of $5/32$ in. diameter. They are well made and very strong and, provided that they are not abused, they will continue to serve the constructor, model

Fig. 1 shows the basic Meccano model-building tools: a. is the Super Tool Set Screwdriver; b. is the standard Screwdriver; c. is the long, wooden-handled Screwdriver; d. is the Drift; e. is the Box Spanner; f. is the standard Spanner. Fig. 2 shows the Drift at work—aligning holes.

after model for a lifetime. Two simple rules will help both in the long life of the Bolts and the correct construction by making sure that there is always a clean entry for the Bolt in the holes of the Meccano Parts which are being secured together and that the Bolt rotates freely as it is tightened. Any tendency for the Bolt to jam or the Nut to stick on the thread should immediately be checked for cross threading arising from careless application of the Nut. Make sure that the Screwdriver blade has a clean square end which is a snug fit into the slot of the Bolt and never sharpen the blade to a cutting edge. This is very dangerous to the person and wreaks havoc with the carefully machined slots in the boltheads.

One of the most useful additional tools for the Meccano constructor is the Drift which is shown with the other basic tools in Fig. 1. This is Part No. 36c and is manufactured to have a full tolerance on its diameter but is shaped to a blunt point at one end which allows the builder to insert the Drift into an assembly of Strips or Plates to align all of the holes prior to bolting up the pieces to make sure that Axle Rods or further Bolts may be inserted cleanly. Fig. 2 shows some of the applications of the Drift and if this is fitted with a Spring Clip or a Collar, the Drift will remain in place when the model is turned to one side and is almost as good as having a third hand.

FIG 3

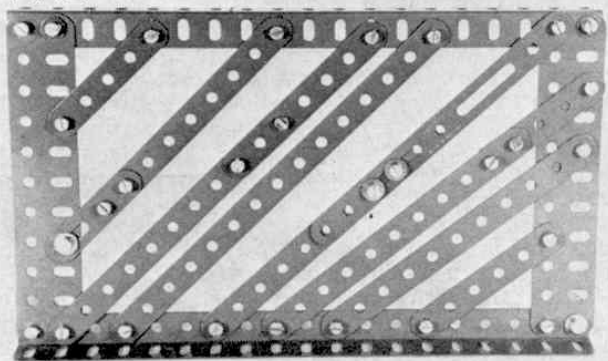

Fig. 3. A demonstration assembly showing how elongated holes in Slotted Strips and other parts enable diagonally-mounted Strips to span inexact distances between anchoring points.

In the simpler models, journals for Axle Rods are quite commonly formed by the holes in Perforated Strips or Plates and two points of support are adequate in such cases. However, where an Axle Rod has to pass through three or more holes in a line, such as often happens in the case of gearboxes, etc., the Drift is invaluable for making sure that all holes are properly aligned. Again, where greater precision or long running operation is required, journals may be provided by Double Arm Cranks, Part No. 62b, or by Bush Wheels, Part No. 24 or 24a, bolted to the Plates or Strips forming the side members of the mechanism. Because Bush Wheels have a peened over lip where the boss is joined, they may be stood off from their respective mountings by inserting a packing Washer on the securing Bolts, as shown in Fig. 5, and then correctly aligned with the Drift which should pass quite cleanly and without binding through both bosses forming a pair of journals.

Meccano Washers themselves, Part No. 38, are a

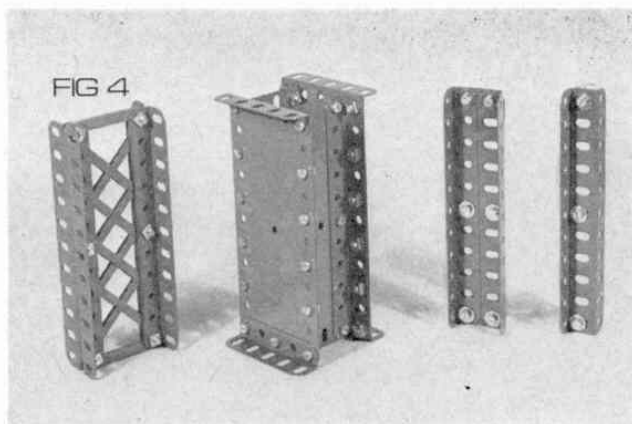
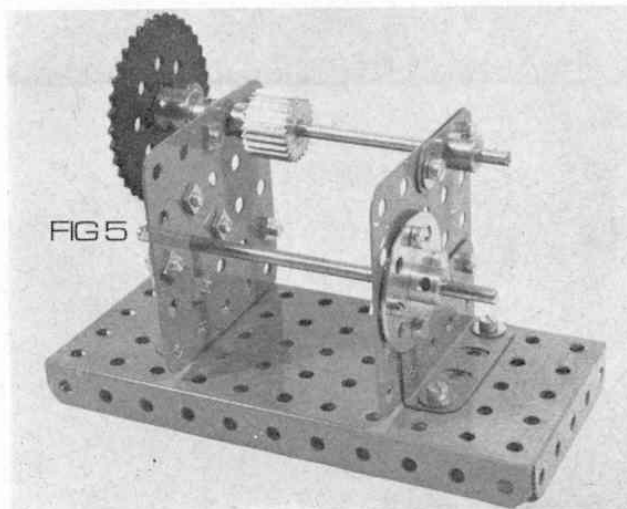

Fig. 4. Some of the many different types of composite girders that can be built up using basic Meccano parts. Just about every type of girder in existence can be reproduced in this way.

most useful if not essential part of the serious constructor's kit as they serve several uses. They may be employed as packing in many applications; they may be placed under the head of a Bolt to protect the enamelled surfaces of Meccano Plates, etc., and to give extra grip from the Bolt in mechanisms subject to vibration. Their most common use, however, is that of providing a smooth running bearing face between the boss of a Gear or Wheel etc., and the journal carrying the Axle Rod. Lubrication of all journals with a tiny spot of light machine oil will assist the smooth running of any model but, if overdone, the process becomes messy and can attract enough dust or fluff to defeat its own object.

If a model is chosen from one of the Meccano construction manuals, the parts list should be checked against available parts and these should be set aside where they are handy and ready for immediate use so that handling or raking over the parts is reduced to a minimum. Bolts and Nuts may be screwed up finger-tight for the early stages of construction until the builder is satisfied that his model is 'coming up

Fig. 5. While the simplest bearings for Meccano Rods are supplied by the holes in Strips and Plates, etc., a stronger, more efficient bearing is supplied by the boss of a suitable part bolted to the Strip or Plate. This picture shows a Double Arm Crank and a Bush Wheel being used in this way.



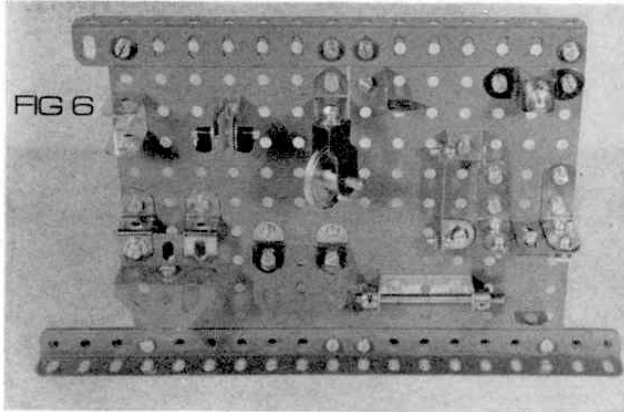

Fig. 6. Some of the many brackets included in the Meccano system with a few examples of the innumerable uses to which they are put.

square'. At this stage, the Nuts should be held quite firmly with the Spanner and the Bolts screwed home firmly with the Screwdriver. Should a really tight grip be required, necessitating a final turn of the Spanner, a Washer should be placed under the Nut to prevent its edges from scoring a circle in the enamel on the Meccano Parts. This enamel is hard wearing but will not stand up to abuses of this kind. On the other hand, a little care in handling and storing the parts can be rewarded with a lifetime of service from your Meccano Outfit.

Every Meccano Manual carries an illustrated list of Meccano Parts, many of which have specialised applications and some of these will be dealt with in a later chapter. Basically, the correct use of Strips, Angle Girders, Plates, Wheels and Axle Rods are most important. Strips are intended principally to act as bracing units or tie rods where they are primarily in tension, i.e. being stretched, but the shorter varieties will carry considerable loads, especially when several thicknesses are combined by means of Nuts and Bolts. Some of the uses of Strips are shown in Fig. 3.

It is a well known engineering principle that the strength of structures relies in many cases on triangu-

lation, it being a fact that a triangle is not readily pushed out of shape, and the range of Perforated Strips is ideal for this purpose. There are occasions, however, particularly where a right-angled structure is required, when the Perforated Strip selected will just not reach across the necessary diagonal and when, in addition, the simple process of bolting on an extra length of Strip is equally unsuccessful. There are two methods available to the constructor to overcome this difficulty. A large range of Meccano Parts, such as Angle Girders, Flat Girders and Flexible Plates, are provided with elongated holes which give considerable latitude in adjusting diagonal constructions, but where this does still not give sufficient scope, special parts known as Slotted Strips, may be used as shown in Fig. 3. Slotted Strips are made in two lengths, Part No. 55, $5\frac{1}{2}$ in. long, and Part No. 55a, 2 in. long, and the slots in these special Strips are also put to good use in models where a sliding Axle Rod mechanism is employed.

Angle Girders combine some of the uses of the Perforated Strip with a part which will stand both compression and tension and this makes any Girder an ideal element in a framework where great strength is required. Laid flat, any strip metal will bend or sag but turned up like a knife edge, it then becomes very rigid in a vertical direction. A Girder always presents at least one of its sections in opposition to its load and will therefore stand up not only to compression and tension but also to bending forces as well. A simple framework of Meccano Angle Girders can be assembled quite quickly to take the weight of a man without showing any signs of stress or damage, although it is not really recommended that the beginner with a small outfit attempts such a venture at the outset! Fig. 4 shows how various forms of girders may be constructed from basic parts.

There are many occasions when the attachment points for various parts of a structure are not directly accessible and for this reason, the Meccano system includes a comprehensive range of brackets in various sizes. The simplest of these is Part No. 12 which is the $\frac{1}{2} \times \frac{1}{2}$ in. Angle Bracket having two holes, one of which is slotted so that a useful range of adjustment is available. A simple development of this part is the Double Bracket, Part No. 11 and this is really extended throughout the entire range of the Double Angle Strips which run from $1\frac{1}{2}$ in. up to $5\frac{1}{2}$ in. with fixing lugs of various lengths, also, in some cases. Fig. 6 shows a number of Meccano Brackets and some of the applications for which they are designed. In each case they simulate standard engineering practice, but whereas a welding or riveting process is frequently used in steel structures, the Meccano constructor must rely upon the Nuts and Bolts. It is therefore very important that they are all very securely tightened in any model which is subject to motion or vibration or substantial weight and, again, the use of Washers for extra grip under Boltheads is very strongly recommended. Meccano brackets perform two principle functions, one being to connect Plates, Strips, etc., at various angles and the other to provide simple bearings or journals for Axle Rods. Some of the brackets have

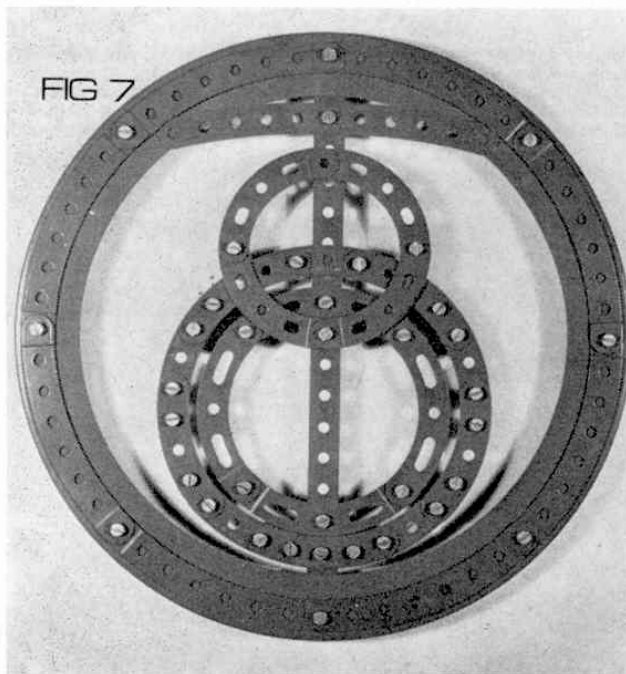
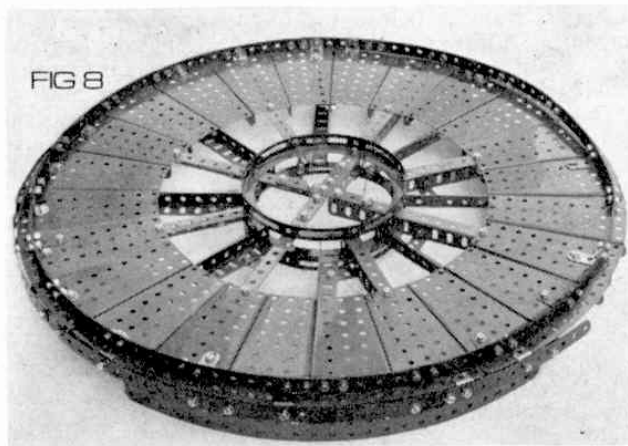

Fig. 7. When bolted together, the various Meccano Curved Strips will make up complete rings of different diameters, as this picture clearly shows. The rings are seen here attached to a $9\frac{1}{2}$ in. Flanged Ring to give an idea of size.

elongated holes and they provide for adjustments previously mentioned.

A development of the Perforated Strip is the Curved Strip and there are no less than five different Curved Strips in the Meccano system, ranging from $2\frac{1}{2}$ in. to $5\frac{1}{2}$ in. length and having curvatures varying in radius from $1\frac{3}{8}$ in. to 10 in. Three of these are 'stepped' curves which means that the end of each strip is cranked slightly to allow the adjacent strip to bed into it without changing the overall level of a completed circle. Fig. 7 shows the range of Curved Strips arranged as complete circles with the exception of the 10 in. radius Strip which is shown as a separate item at the top of the display. The decorative value of the Curved Strip is evident from the illustration but they may be used structurally of course to form flywheels and formers for cylinders. Part No. 90, the $2\frac{1}{2}$ in. Curved Strip is of

Fig. 8. The one non-rectangular flanged plate in the Meccano range is the Flanged Sector Plate, Part No. 54. Designed as a small sector of a large circle, twenty-four Plates are required to make up the complete circle.



interest to clockmakers as it forms a circle having 30 holes and makes a wheel for a 30-peg escapement in conjunction with a pendulum of royal length. The slotted holes in two of the Curved Strips, 89a and 90a add to the versatility of their use. All radii are measured from hole centres.

While Strips and Girders form the 'skeleton' of general Meccano structures, Flat Plates and Flanged Plates complement the construction by serving as bases and supplying extra rigidity and large perforated areas for the purposes of providing journals for mechanisms, anchoring points for brackets and Girders and standard spacing for gear meshing, etc. Examples are illustrated in Figs. 2, 5 and 6.

Flanged Plates are produced with flanges to give the same sort of edge rigidity as is found in Angle Girders. They are made in a similar gauge of steel to that used for Perforated Strips up to $5\frac{1}{2}$ in. in length and provide adequate strength for virtually all requirements. Flat Plates are made in a thicker gauge to give them rigidity in a flat plane and they range in size from $1\frac{1}{2}$ in. square up to $5\frac{1}{2} \times 3\frac{1}{2}$ in. In each case they are fully perforated at standard half inch spacing. Although the majority of the Plates mentioned are of rectangular form, the Sector Plate, Part No. 54 is an exception since it was originally designed to form a sector of quite a large circular platform. This is illustrated in Fig. 8 which shows a complete circle of Sector Plates forming the base for a Giant Dragline. It is interesting

to note that this circle is 20 in. in diameter and the outer curved edge formed by the Sector Plates is the same as that formed by the largest Curved Strip which is of 10 in. radius.

The versatility of the Meccano system was considerably extended some 36 years ago when Flexible Plates were introduced—originally in cardboard and fibre, but these being quickly superseded by thin-gauge flexible steel plates which have remained in the system ever since. They are available with a width of $2\frac{1}{2}$ in. and with lengths varying from $1\frac{1}{2}$ in. to $12\frac{1}{2}$ in. Their general applications for filling in large areas on the surface of models and for providing curved surfaces are well known to the Meccano constructor, but their application extends beyond this. They may, for example, be used as very strong webs for large girders (see Fig. 4) by employing several thicknesses of Flexible Plates and, as they are all made with elongated holes at their ends, they allow a considerable amount of latitude in adjustment. They will also make up into cylinders, over a very wide range of diameters and a further advantage in using Flexible Plates is that, when they are formed into cylinders, they possess very rigid properties in the line of the axis of the cylinder. That is to say, if a cylinder is made from Flexible Plates bolted to the flanges of a pair of Circular Girders (Part No. 143), it forms a very strong drum which will form a very stable base for constructions of towers, etc. capable of supporting considerable loads. This follows the well-known mechanical property of sheet metal bent to circular or corrugated forms, Fig. 9 illustrating the use of Flexible Plates for this purpose.

Triangulation has already been mentioned in connection with mechanical rigidity and this is catered for in the Meccano system by a range of Triangular Plates as well as formations of Perforated Strips. These Plates fall into two categories, i.e. rigid and flexible, and the largest in the first category is Part No. 76, $2\frac{1}{2}$ in. Triangular Plate. This is very useful as a journal plate or centre plate and its slotted holes permit meshing of gears in non-standard spacing. Part No. 77 is the 1 in. Triangular Plate which is useful for supplying a mid-point anchorage or journal at half standard spacing because of its equilateral form. Other triangular forms of rigid parts are found in the Trunnions, Part Nos. 126 and 126a, Corner Brackets, Part Nos. 133 and 133a.

Fig. 9. The main use of Meccano Flexible Plates is to fill in large open areas of a model, but they can also be used in the construction of special drums which, when completed, will take tremendous weights. One such drum is shown in this picture.

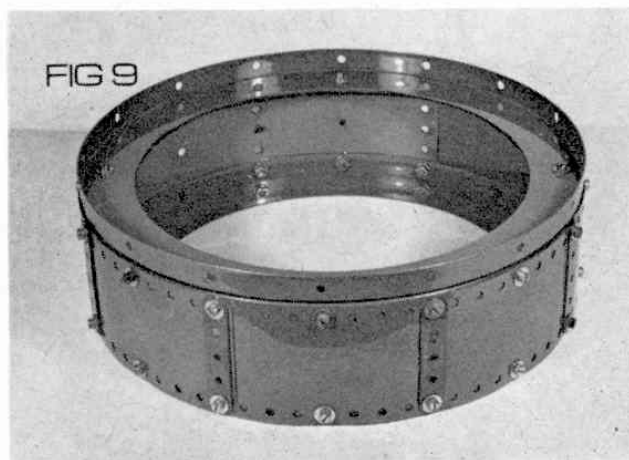

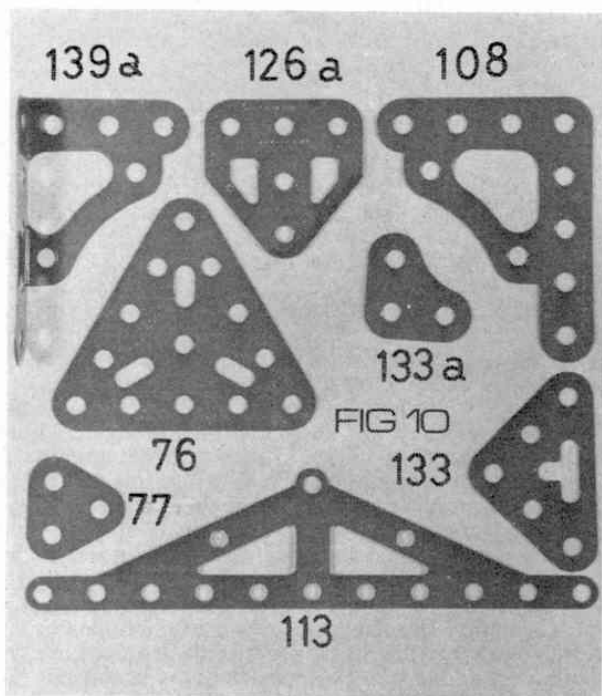

Fig. 10 and Fig. 11 show examples of the many types of triangular-shaped parts contained in the Meccano system. Because of their shape, triangular parts will withstand a great deal of pressure.

Some of the Triangular Flexible Plates have slots to facilitate adjustments and these are illustrated in Fig. 11.

Actually, a type of Flexible Plate was in use in the Meccano system almost sixty years ago and is still with us to-day. This is the Braced Girder which has featured extensively in Meccano models and structures since their first appearances in the early Manuals of Instructions and the Meccano Magazine. It has both structural and decorative properties and is shown in Fig. 4 as the bracing web of a deep 'H' girder, where several Braced Girders (reversed to give the 'crossover' appearance) are used.

A Meccano illustrated price list shows Part Nos. listed up to 234f but so many parts of a similar type are listed as a,b,c,d,e, etc., that there are well over 250 parts in the system. The objects of this first part of the series for Meccano Constructors has been to review the basic parts with which the builder should acquaint himself before tackling the more ambitious models. A fuller development of the system will be dealt with in these pages over the next 11 months, during which time a number of topics will be covered in subsequent articles. Part II next month will deal extensively with gearing and transmission in general and will be fully illustrated, as will be the rest of the articles throughout the series.

Corner Gusset, Part No. 108, Flanged Brackets, Part Nos. 139 and 139a and the Girder Frame, Part No. 113. The above are illustrated in Fig. 10.

As a complement to the Flexible Plates, a series of Triangular Flexible Plates was introduced into the system in the 1950's which extended the versatility of the system still further. Used in single layers, the Triangular Flexible Plates are principally used for filling appropriate shapes as a surface covering but if several thicknesses are bolted together and used in conjunction with Angle Girders they provide extremely strong corner structures. Again, by overlapping a pair of Triangular Plates, after reversing one of them, a rectangular plate is formed and as there are six different sizes available, an extension of the range of rectangular Flexible Plates is immediately available.

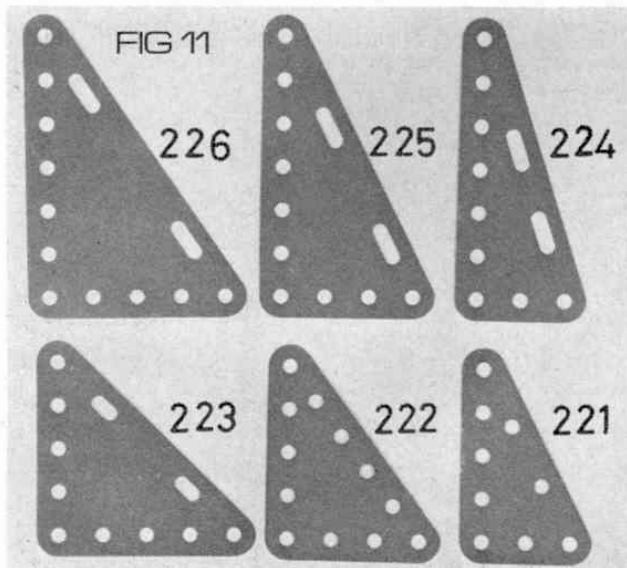

New Book for Dinky Toy Collectors

Price 5/-

All serious Dinky Toy collectors, worthy of the name, will have heard of the book "History of British Dinky Toys 1934-64" by Cecil Gibson. The book is invaluable to collectors, and is limited only in that it deals exclusively with what can be described as "ground vehicles"—cars, lorries, buses, etc. This is perfectly understandable considering the number of models which fall under the heading, but it does mean that the growing band of die-cast aircraft collectors as well as the old waterline ship series collectors do not have anything like the same detailed information to draw on as the vehicle collectors. I should say, "did not", because the aircraft men are now well and truly catered for with the publication of a 16-page foolscap-size, stereotyped booklet entitled "The Dimmock-Jackson Checklist of Dinky Toys Aircraft".

Produced by Alan Dimmock and Leslie Jackson, this booklet contains a wealth of information on every known Dinky aircraft save the two latest examples which were released after the booklet had been finished. It identifies each model, gives its year of introduction and a concise description of its salient features. A great deal of effort must have gone into the preparation of the booklet which is being made available at its cost price of 5/-. It is produced purely as a service to collectors and is entirely non-profit-making: hence the low price. It can be obtained from either Mr. A Dimmock, 2 Wynter Road, Southampton, SO2 5NY or Mr. L. Jackson, 369 Lower Broughton Road, Salford 7, Lancs M7 9HR, and it's well worth the price.

Meccano Constructors Guide

by B. N. Love

Part 2 – Pulleys, sprockets and gears

ACTION MODELS invariably have the greatest attraction for Meccano enthusiasts of all ages and this chapter deals with some of the aspects of putting Meccano models in motion.

Wheels and axles were among the earliest components in the system and a simple range of gears and sprocket wheels followed shortly after the inception of "Mechanics Made Easy", the forerunner of Meccano, more than half a century ago. The family of Pulleys illustrated in Fig. 1, vary very little from

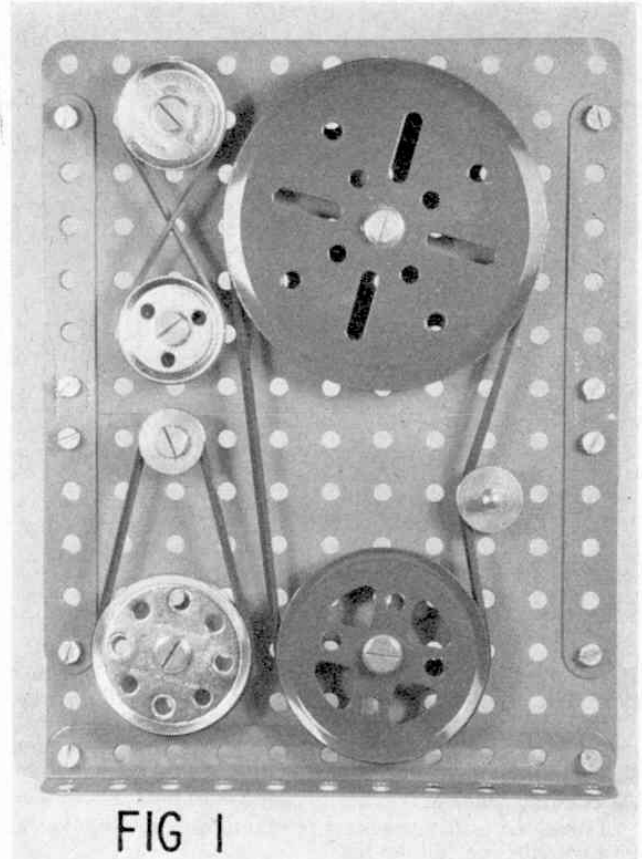

FIG 1

their original design and give a range of diameters from $\frac{1}{2}$ in. to 3 in. When used with an equally wide range of Meccano rubber Driving Bands, a large number of pulley ratios are obtainable. Both the $\frac{1}{2}$ in. and 1 in. Pulley are available with or without boss but where no boss is fitted, the Pulley is described as "loose" and is used principally as a guide pulley in cord hoisting mechanisms or for making up multi-sheave pulley blocks.

Considerable power may be transmitted by Meccano Pulley drives which may be reinforced by using a system of twin Pulleys and double Driving Bands. An example of this is shown in Fig. 3, where Pulleys are successfully used in conjunction with a gear-box to transmit motion to a sophisticated model of a self-programming Fairground model. There is plenty of scope, both in simple and more advanced models for the use of pulley drives and the rubber Driving Bands give excellent latitude in tensioning and positioning of their respective Pulley Wheels. These Bands are manufactured in "light" and "heavy" gauge to suit individual power requirements.

When calculating pulley ratios, the diameters of the various Meccano Pulleys may be taken as an approximate guide so that a 1 in. Pulley driving a 2 in. Pulley will give a step down ratio of 2 : 1, but the belt drives in general have the disadvantage of stretching which can, in turn, cause slipping or "creeping" of the driving belt. Ratios must therefore be considered to be approximate.

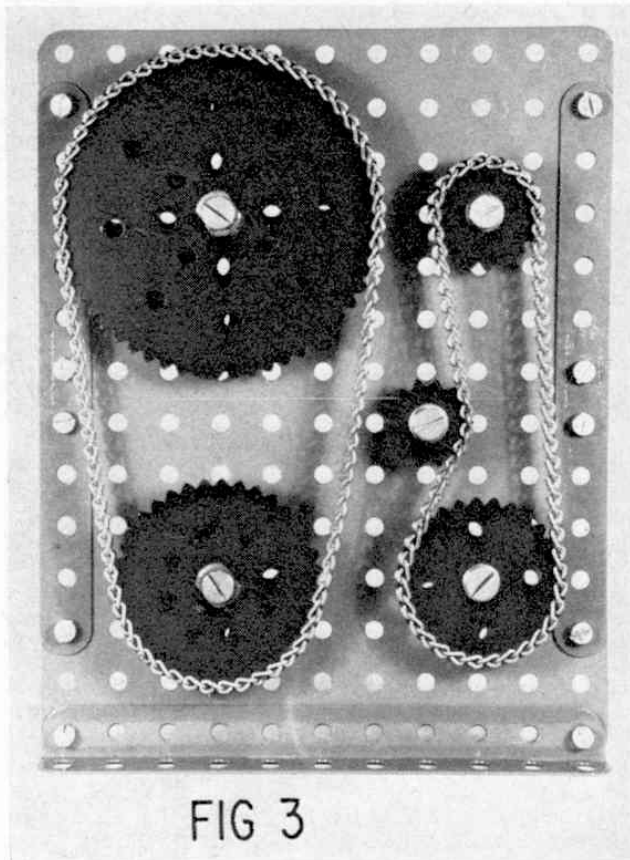

FIG 3

Fig. 1. The basic gauge of Meccano Pulley Wheels. The $\frac{1}{2}$ in. Pulley without boss acts as a "jockey" pulley to increase belt tension. The twisted belt provides a reverse drive.
Fig. 3. The basic range of Meccano Sprocket Wheels.

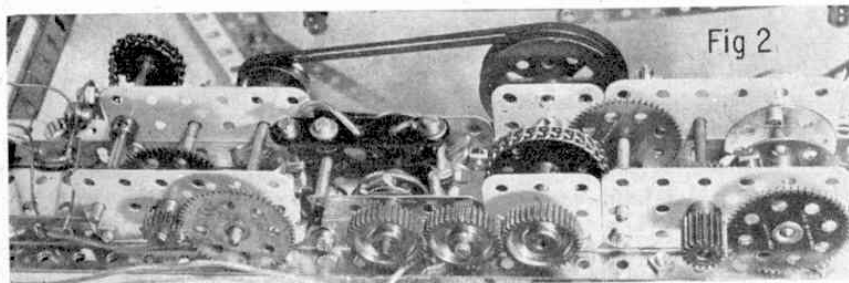
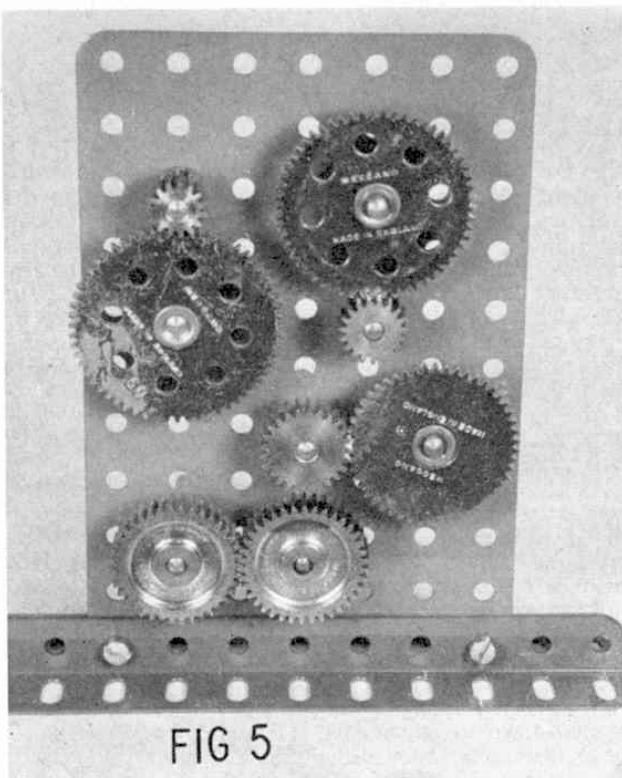
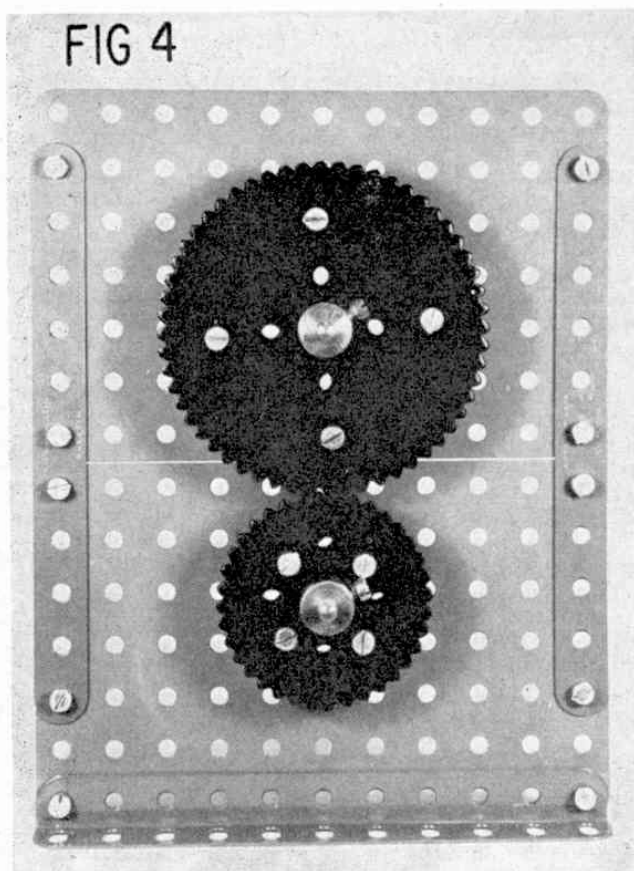

Fig. 2. Pulleys, sprockets and gear wheels in combination to operate an accurate programming mechanism. Fig. 4. Meccano Sprocket Wheels paired-up to give direct meshing as heavy duty spur gears. Fig. 5. Range of pinions and gear wheels giving four different ratios ranging from 1 : 1 to 4 : 1.

Where it is important that a mechanism must have its various movements running in step, or "synchronised", the role of the pulley drive may be taken over by Meccano Sprocket Wheels and Sprocket Chain. Since the Sprocket Wheels are cut with similar tooth forms and are available in directly related ratios, it is a simple matter to employ them for driving widely separated shafts with a guarantee of accurate timing. Fig. 3 shows the basic range of Sprocket Wheels available, but it is important to remember, here, that while the diameters of the parts can be used as a guide in calculating Sprocket ratios, the exact ratios can only be determined by the number of teeth each part has. For example, the diameter system indicates that a 1 in. Sprocket driving a 3 in. Sprocket results in a ratio of 3 : 1, whereas, the exact ratio is 56 : 18 or slightly more than 3 : 1. Generally speaking, therefore, diameters are more a guide to the spacing of shaft centres, while teeth numbers enable ratios to be calculated accurately.

It is not generally realised by Constructors that Part No. 168b, Ball Thrust Race Toothed Disc, 4 in. dia. is also a useful sprocket wheel when bolted to a Bush



Wheel or similar centre. Furthermore it has the peculiar number of 73 teeth. By arranging for this Toothed Disc to be engaged by a rotary shaft carrying a Fork Piece radially mounted, the 73-toothed Disc can be advanced one tooth at a time. If, in turn, its own shaft drives a 5 : 1 reduction ratio, an overall ratio of $73 \times 5 = 365$ is obtained. This should be of great interest to clock builders, being a very simple method of recording a complete year's calendar movements!

A further unorthodox feature of the Meccano Sprocket system is that Sprocket Wheels may be directly engaged as coarse-toothed gears and, by bolting them in pairs, a substantial area of tooth meshing is obtained together with rugged drive properties and an excellent reproduction of "period" gearing reminiscent of the days of the great engineers Matthew Boulton and James Watt in the early Industrial Revolution. Fig. 4 shows an example of such an arrangement. As all Sprocket Wheels of $1\frac{1}{2}$ in. diameter or greater are perforated with radial holes, they serve very well as hub centres for heavy rotating structures and as the 2 in. and 3 in. Sprockets have heavy duty brass bosses they are capable of supporting very stout structures.

For a high degree of precision and an infinite range of ratios the Gear Wheels and Pinions in the Meccano system may be employed with the utmost confidence.

FIG 6

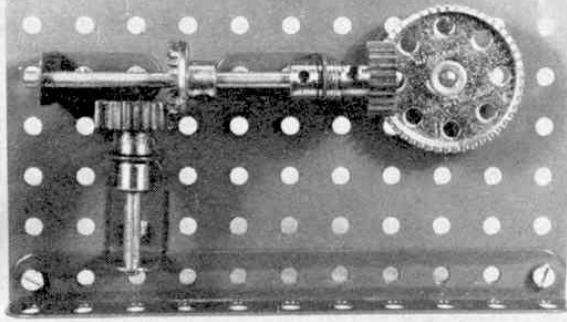

Fig. 5 shows a few simple arrangements of Gears with standard spacing in ratios suitable for general model building. These are calculated in each case by noting the *numbers of teeth* (not diameters) and making a fraction from the two numbers obtained from any meshing pair. If the arrangement is used to obtain increased speed (with resulting reduced power, or "torque"), it is known as a step-up ratio, one example of which is a 50-teeth Gear Wheel driving a 25-teeth Pinion, the step-up ratio being $50/25$ or $1:2$. If the Pinion drives the Gear Wheel, a step-down or reduction ratio (with increased torque) is obtained, in which case the ratio would be $2:1$.

As the Constructor advances in his model building techniques, gear ratios will become more important and if an accurate timing device is required in a particular mechanism, a sound knowledge of the required ratios is essential. It is a common error among novice builders using gear drives for the first time to *add* gear ratios when there are several rotating shafts in a gear-box. This is wrong, of course, as the action of one gear ratio driving a second or third, is to *multiply* the ratios in step up arrangements and to *divide* them in step-down arrangements. Referring back to Fig. 2 as an example, the pulley shaft carries a 19-teeth Pinion meshing with a 57-teeth Gear to give a first stage reduction of $3:1$. Next, a 25-teeth Pinion passes on the drive to a 50-teeth Gear Wheel, giving a second stage reduction of $2:1$ and, finally, a long-faced 19-teeth Pinion transmits the drive to a 57-teeth Gear Wheel giving a third stage reduction of $3:1$. Putting these three ratios in combination we now get $3 \times 2 \times 3 = 18$ so that the whole gear train in this case gives

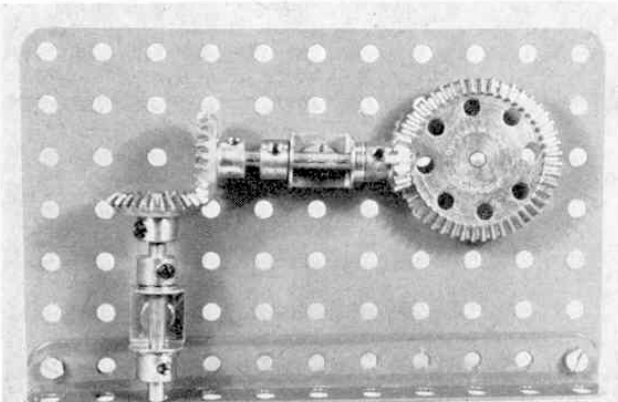

FIG 7

a reduction ratio of $18:1$.

The gear arrangements shown in Fig. 5 are all mounted on shafts set in bearings which are spaced 1 in. apart and provide ratios from $1:1$ down to $4:1$. Gear diameters are quoted on the official parts list and, generally speaking, if the diameters of a pair of meshing gears are added and then divided by 2, the centre distance of the driving shafts is obtained. However, in the case of the Pinion, Part No. 26c, and the Gear Wheel, Part No. 27d, which combine at 1 in. spacing to give a ratio of $4:1$, the sum of the diameters is $2\frac{1}{16}$ in. and when this is halved, the result is $1\frac{1}{32}$ in., but the discrepancy is not sufficient to effect the smooth meshing of these two gears at 1 in. spacing. Larger ratios are obtainable directly by meshing the 19-teeth Pinion with the $2\frac{1}{2}$ in. or $3\frac{1}{2}$ in. Gear Wheel, when ratios of $5:1$ and $7:1$ respectively are obtained.

All of the foregoing gears are known as "spur" gears and are of simple tooth form meshing together on parallel shafts.

To effect a change of direction in gearing requires the use of gears which have their teeth turned at an appropriate angle. The simplest form of such a gear in the Meccano system is the Contrate Wheel illu-

FIG 8

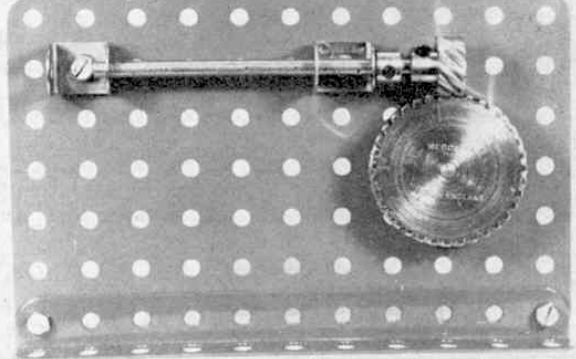

strated in Fig. 6. Two sizes are available, namely the $\frac{3}{8}$ in. diameter 25-teeth and the $1\frac{1}{2}$ in. diameter 50-teeth Contrate Wheels. When meshed with 25-teeth Pinions as shown, they provide $1:1$ and $1:2$ ratios respectively. They can, of course, be meshed with other Pinion sizes to provide other ratios, calculation again being done simply by comparing teeth numbers.

A development of the contrate is the bevel gear and this is also available in the Meccano system following standard engineering practice. Bevel Gears give a much stronger and quieter drive than Contrate Wheels owing to the careful formation and meshing of the teeth to provide a drive at right-angles. They are assisted in their performance by the fairly wide surface contact of teeth provided. One pair of Bevel Gears, Part No.'s 30a and 30c are designed to be used as a matched pair as the teeth angle of the larger gear is cut to complement that of the smaller. As they have 16 teeth and 48 teeth respectively, they provide a $3:1$ ratio. Part No. 30, the $\frac{7}{8}$ in. Bevel Gear has 26 teeth cut at an angle of 45° and is used with a second Bevel Gear of the same size to provide a strong right-angle drive with a $1:1$ ratio. These are illustrated in Fig. 7.

Fig. 6 Contrate drive giving two changes of direction and $2:1$ gear reduction. Fig. 7. Bevel gearing giving two changes of direction and $3:1$ reduction. Fig. 8. Helical drive giving right angle change of direction with axes mounted in different places.

Perhaps the most interesting Meccano gears are the pair of Helical Gears, Part No.'s 211a and 211b. Motion through Helical Gears is transmitted by a cross-sliding action and the teeth are cut with a twisted curve so that the faces of a meshing pair are at right-angles. Accurate location of shafts driven by Helical Gears is essential if smooth action is to be obtained, but when properly set up and lightly lubricated, they provide a very smooth chatter-free and almost silent drive. Although designed as a matched pair, the smaller of the Helicals can be meshed with one of its own kind to give a 1 : 1 ratio, but some adjustment in standard spacing between the right-angle shafts is necessary to achieve this. When the normal pair, 211a and 211b are used, the ratio is approximately 1 : 3 although, in practice, they do not give an exact whole number ratio, counting the teeth. A helical drive is shown in Fig. 8.

When taken to its logical conclusion, a helical drive becomes the Worm and Pinion arrangement shown in Fig. 9. The Worm Wheel has a helix or "pitch" such that one revolution of the Worm will produce a movement in its driven Pinion equivalent to the distance of one tooth width. This makes gear ratios very simple to calculate since it is necessary to know only the number of teeth on the engaged Pinion or Gear Wheel. Hence, when meshing with the $3\frac{1}{2}$ in. Gear Wheel, the worm will provide a reduction ratio of 133 : 1.

While the Meccano Helical Gears may be driven in either direction the Worm cannot be "back-driven", i.e. turned by the Gear Wheel with which it is meshed. This has some disadvantages but they are few and are outweighed by the advantage that a Worm drive provides its own brake so that, when employed in crane winding drums, etc., the moment power to the Worm shaft is stopped, the load will not be able to overdrive the worm because of the non-reversible nature of the Worm's helix.

Gear arrangements illustrated so far are simple ones, but when built into compound gear trains or gearboxes, they open up the Meccano system to its fullest extent, and the versatility of the Meccano system is limitless. Once the constructor has experimented with simple reduction gears in working models, gear changing and reverse mechanisms follow as a natural development. A very simple two-speed gearbox is illustrated in Fig. 10. The shaft receiving the drive from a hand wheel, clockwork or electric motor, etc., is known as the "input" shaft and the final shaft passing on the motion to the model movements is known as the "output" shaft. In Fig. 10 the input shaft (a) carries two Pinions of different sizes, while the output shaft (b) carries two different Gear Wheels to mesh with their respective Pinions, as required. A long-faced Pinion is secured to one end of the output shaft, which is free to slide in its bearings, being moved by a simple gear shift lever. It is important that one pair of gears is completely out of mesh before the second pair engages, or the mechanism will jam. The purpose of the outside Pinion is to provide a take-off point for additional gearing, its long face allowing the output shaft to slide through a distance adequate for gear changing.

It is sometimes convenient to use a similar arrangement for the simple purpose of reversing the drive from the output shaft. In this case, a 1 : 1 reverse drive can

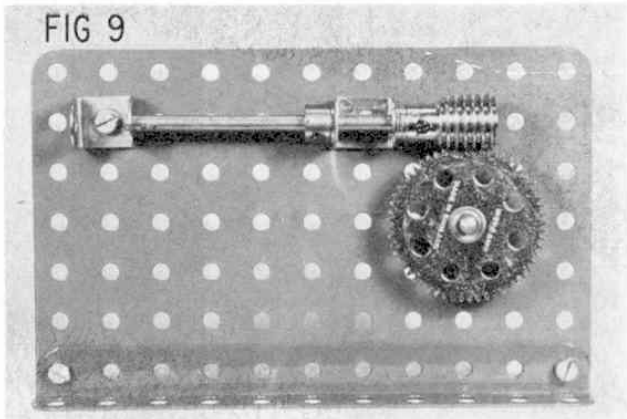

Fig. 9. A Worm drive, considered to be the final development of a helical drive.

be achieved by making one pair of gears from 1 in. Gear Wheels and inserting an intermediate gear known as an "idler" between a pair of Pinions at the other end of the gear change shaft. To keep the shaft spacing correct, three 19-teeth Pinions are used "in line", the centre Pinion being secured to the side plate of the gearbox by a 1 in. Bolt on which it is free to rotate or "idle". Its purpose is to pass on the rotation of the input shaft to the output shaft in the same direction, the reverse drive being effected by the pair of 1 in. Gear Wheels, when meshed at the other end of the shafts.

Next month, I will continue to explain the uses of Meccano Gears, and then combine the basic points outlined in the first two parts of this series and deal with crane structures.

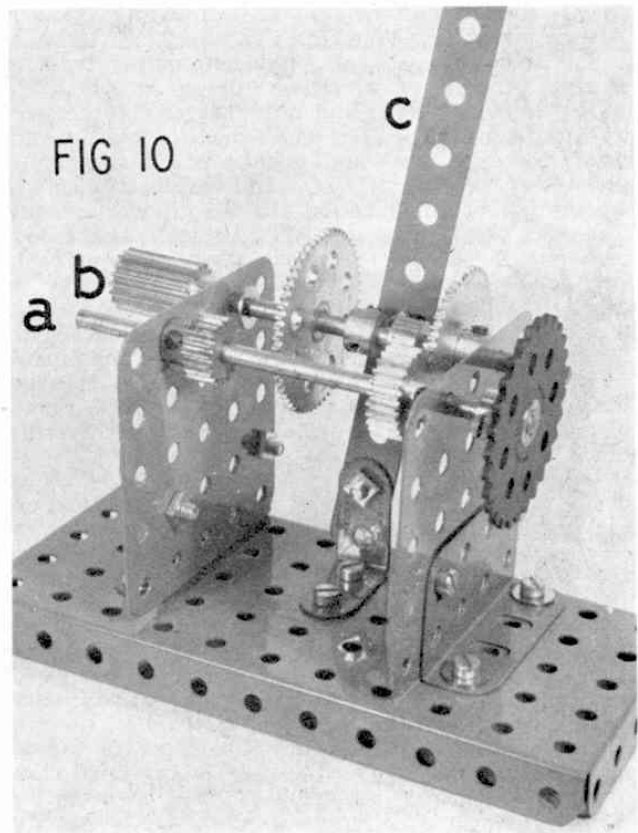

Fig. 10. A simple form of two-speed change-over gearbox. The input shaft (a) receives the drive via its Sprocket Wheel which is then passed on to either of the two Gear Wheels on the output shaft (b) by means of the gear shift lever (c) which is pivotted by a lock-nutted Bolt to the 1 x 1 in. Angle Bracket and carries a Bolt engaging between the two central Collars on the output shaft.

Meccano Constructors' Guide

by B. N. Love

Part 2 (continued)

Gears . . .

AN EXCELLENT example of these latter mechanisms is embodied in the automatic gearbox illustrated in Fig. 11. The input shaft is identified by the 2 in. Sprocket Wheel which receives a chain drive from an electric motor. In addition to the 19-teeth Pinion and 1 in. Gear Wheel, the input shaft also carries a Worm at its centre. The idler Pinion, also of 19-teeth, can be seen clearly, bolted to the side of the gearbox frame by means of a $\frac{3}{4}$ in. Bolt and double lock-nuts. The output shaft carries a third 19-teeth Pinion and a second 1 in. Gear Wheel between the side frames and a 19-teeth Pinion with a $\frac{3}{4}$ in. face at its extreme end.

The under view of the gearbox in Fig. 11 shows the "secret" of the automatic operation. A 57-teeth Gear Wheel mounted on a $1\frac{1}{2}$ in. Axle Rod is free to turn in journals made from a Double Bent Strip and the end plate of the gearbox. This Gear Wheel carries a Slide Piece secured by its Grub Screws to a $\frac{3}{8}$ in. Bolt carried in one of the radial holes of the Gear Wheel. The Slide Piece pivots freely on its Bolt and holds a $3\frac{1}{2}$ in. Perforated Strip in its jaws. The centre hole of this Strip has a standard Bolt lock-nutted firmly in position so that the bolthead engages between the boss of the 1 in. Gear Wheel on the output shaft and a Collar next to the final 19-teeth Pinion. The upper end of the $3\frac{1}{2}$ in. Strip pivots on a $1\frac{1}{2}$ in. Axle Rod held firmly by a Crank reinforced by four $2\frac{1}{2}$ in. Perforated Strips bolted to the end plate of the gearbox. The $3\frac{1}{2}$

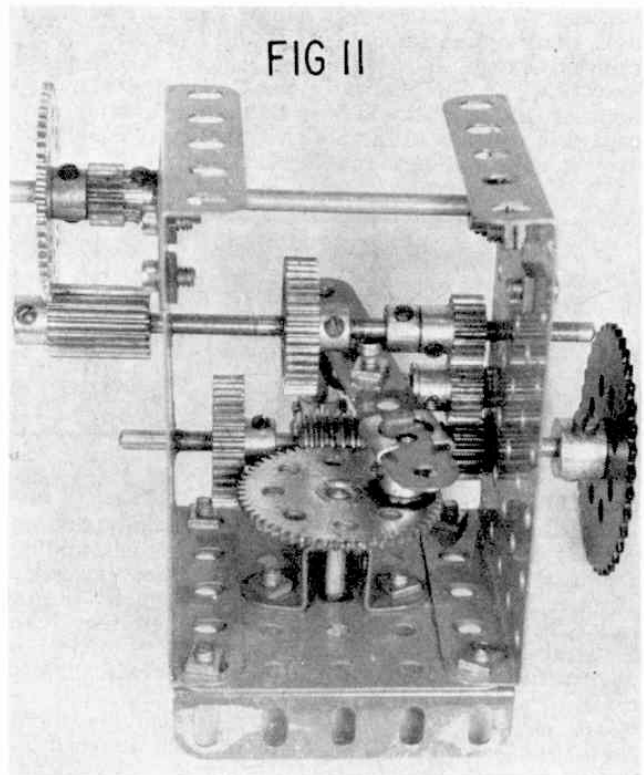

Fig. 11. The automatic reversing gearbox. The top view shows the pivot arrangements at the upper end of the gear change lever. The under view shows the Worm-driven Gear Wheel which moves the gear-change lever.

in. Strip is positioned at its pivoting end by a Collar locked to the fixed pivot rod and a $1\frac{1}{2}$ in. Perforated Strip bolted to the $3\frac{1}{2}$ in. Strip three holes down from the top, but spaced from it by a second Collar through which a $\frac{3}{8}$ in. Bolt is passed. This construction forms a parallel fork giving stability to the $3\frac{1}{2}$ in. Strip when it is moved across the face of the 57-teeth Gear Wheel by the Slide Piece.

Operation is as follows: as the input shaft rotates, the Worm drives the 57-teeth Gear Wheel which rotates slowly and causes the Slide Piece to traverse its face. In so doing, the Slide Piece causes the $3\frac{1}{2}$ in. Strip to oscillate, also very slowly, and the Bolt located in the centre of the Strip simply moves the output shaft alternately left and right, thus changing over the meshing from the 19-teeth Pinions to the 1 in. Gear Wheels and vice versa. As mentioned before, this gear arrangement gives a 1:1 ratio, but provides for a slight "pause" when neither gear on the output shaft is actually engaged. This particular mechanism is very suitable for a demonstration model which carries out repetitive movements requiring a continued reversing sequence. In other words, the mechanism is entirely self programming.

No chapter on the use of Meccano Gears would be complete without a mention of two special forms of application which offer tremendous scope for the advancing model builder. These are the Differential Gear and the Epicyclic Gear. At this stage of the Constructors' Guide it is not intended to discuss them

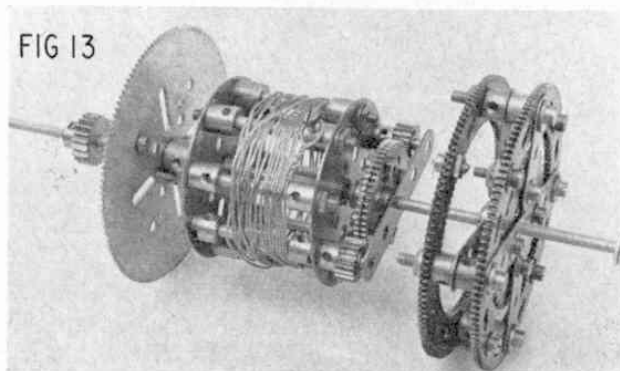

Fig. 13. The epicyclic gear made from Meccano parts. The upper view shows the component parts which made the self-maintaining clock winding drum in the lower view.

at length as they will feature in other mechanisms to be dealt with in later chapters. However, Fig. 12 illustrates two applications of the Differential Gear, the upper view showing the use of it in the rear axle drive of a heavy duty crawler tractor. In this case, the differential "cage" carrying two Pinions and two Contrate Wheels is rotated by a Pinion drive applied to a $2\frac{1}{2}$ in. Gear Wheel bolted to the cage. This gives a very powerful drive to the rear axle assembly, but allows either "half-shaft" to rotate at different speeds for steering and braking purposes. This mechanism will be more fully explained in a later chapter dealing with motor vehicle transmissions.

The lower illustration of Fig. 12 shows an unusual application of the differential, this time in the works of an astronomical clock. As this particular clock shows the phases of the moon with great accuracy, the dial which shows the moon information is supplied with motion from different sources, all coupled to the clock's 24-hour timing mechanism and finally fed to the moon dial shaft via a differential gear which can be seen in the illustration.

Finally, possibly the most sophisticated of all the gear systems available in Meccano are the epicyclic gear arrangements. Briefly, these consist of "sun and planet" mechanisms in which a Pinion or similar gear "runs round" a central gear in the same way that a planet orbits the sun, so to speak. Part No. 180, the $3\frac{1}{2}$ in. diameter Gear Ring, is of great assistance in forming epicyclic arrangements as it has both internal and external teeth. Fig. 13 shows a "self-maintaining" winding drum for a weight driven apparatus in which the weight will still continue to drive the mechanism, even while the weight is actually being wound up.

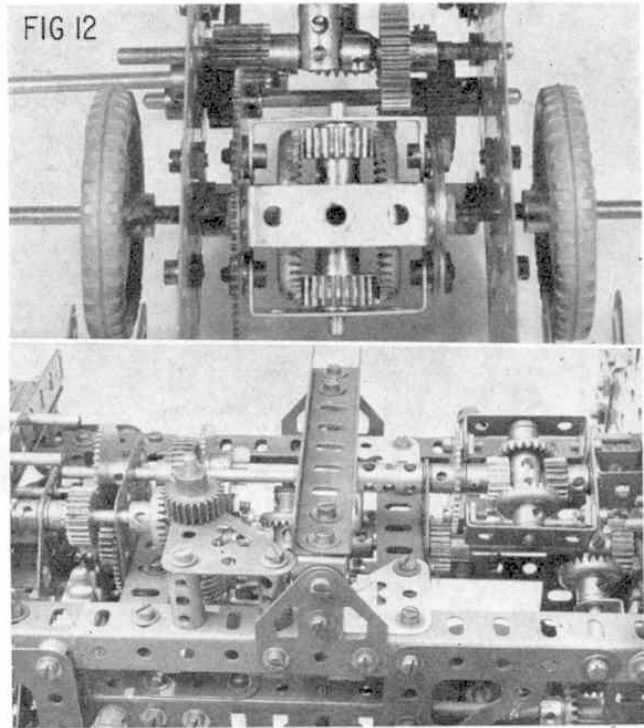

Fig. 12. Two applications of the Differential gear. Upper illustration shows its use in the rear axle assembly of a tractor. Lower view shows its use as a "mixing" box for clock motions combining to show lunar movement.

Part 3 : Basic Crane Structures

FOR THE majority of Meccano enthusiasts a working model of a crane is among the first of their endeavours and for many it remains an ambition to build bigger and better cranes as they grow older and their outfits grow larger. In this chapter we shall be considering basic crane structures and their development. Probably the simplest and oldest crane in history is the pole hoist, known as the 'Shaduf' and used by desert farmers for countless centuries to raise water for the irrigation of their land. Fig. 1 shows how basically simple the Shaduf is. A counterbalanced pole carrying a rope fixed to a bucket at one end and a heavy stone at the other is pivoted by a rope lashing at the top of a forked post set firmly in the ground. The point of pivot is arranged to give the farmer a mechanical advantage adjustable to his height, reach and the weight of the filled bucket so that minimum effort is required to raise the water.

The invention of the windlass was an early development of applying a lever in rotary fashion for raising weights and we are all familiar with the examples of this found over water wells, etc. By adding a pulley to the system, at a fixed height, the primitive crane developed into its basic mechanical form of the crane so that drawbridges, sacks of corn and stone blocks were handled quite easily by our forefathers. However, such fixed hoisting systems suffered from lack of mobility and the need for portability gave rise to the

use of 'sheerlegs', a simple Meccano model of which appears in Fig. 2. This is simply a pair of strong poles lashed together at the top to support a single pulley block and set on the ground with 'feet apart', rope stays being used to support the sheerlegs. In the Meccano model, Axle Rods are used to form the legs and Meccano cord is used for the stays and hoisting ropes. Despite its crude design, this simple crane has the advantage both of portability and of 'luffing', i.e. the sheer legs can be raised or lowered to alter the 'reach' of the crane. The huge stone blocks of the ancient Pyramids and world-famous cathedrals were

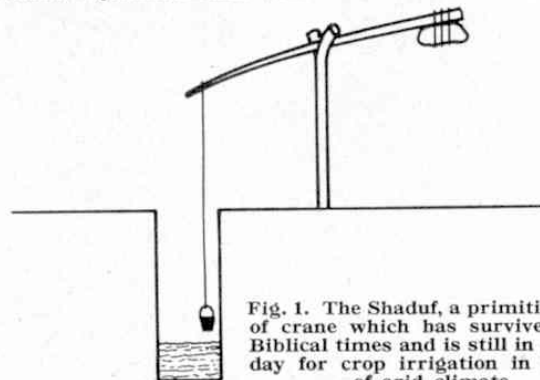

Fig. 1. The Shaduf, a primitive form of crane which has survived from Biblical times and is still in use today for crop irrigation in regions of arid climate.

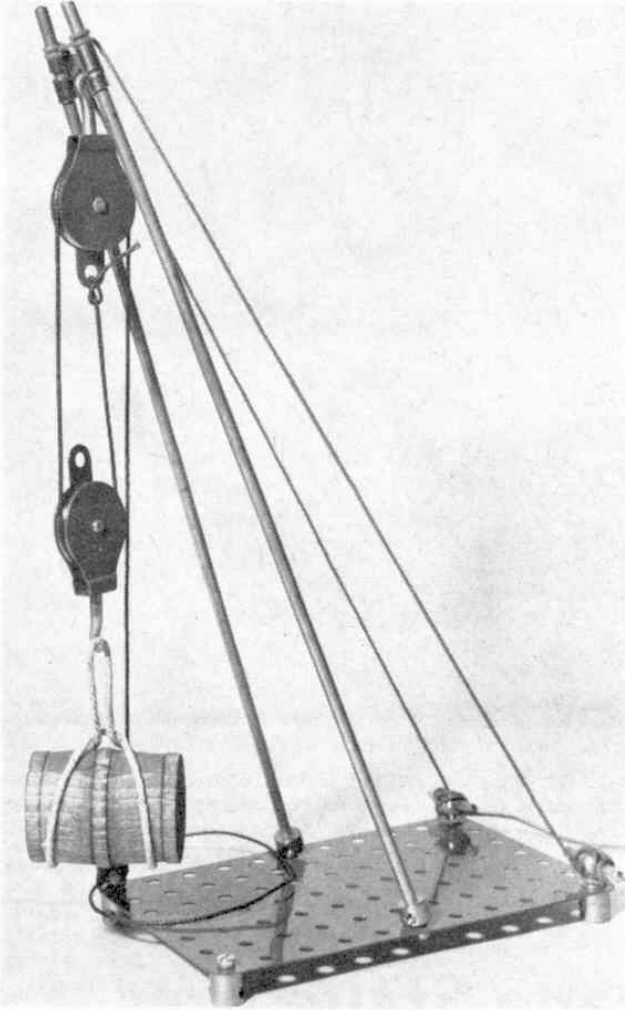

Fig. 2. Meccano model of a Sheerlegs, a simple but versatile crane.

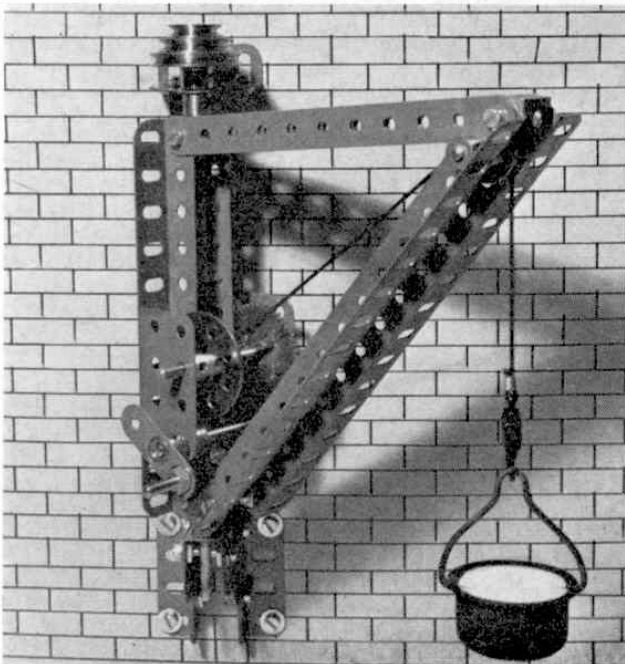
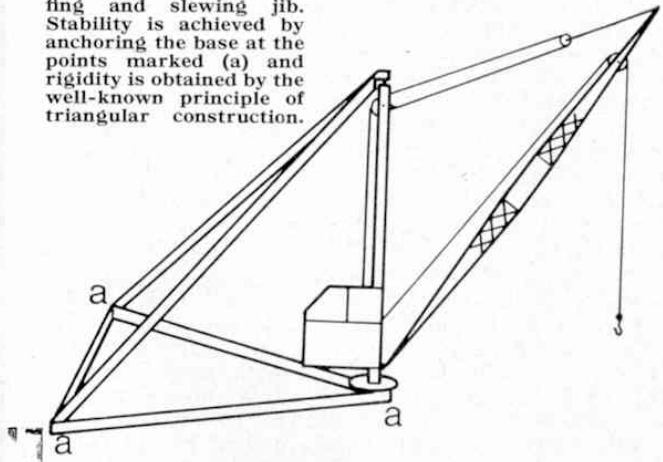

Fig. 3. Typical outline of a derrick crane with luffing and slewing jib. Stability is achieved by anchoring the base at the points marked (a) and rigidity is obtained by the well-known principle of triangular construction.



set in place by such simple tackle and today's jobbing builder with a steel joist to raise on a small building job still uses sheerlegs in preference to an expensive hiring of a mobile crane.

When men were able to strengthen their sheer legs with iron bands and to provide cast iron gearing, the derrick crane evolved as the natural course. The twin sheer legs were replaced by a single jib and, once again, the basic rigidity of triangular construction was well exploited in supporting the jib (see Fig. 3). A major improvement lay in the fact that not only could the derrick crane be 'luffed' but the jib could also be 'slewed', i.e. rotated at its base so that the jib could swing in a wide arc.

Much of this natural development evolved from the use of ships' spars as harbour derricks. When the huge square sails of the old sailing ships were stowed below, the sail spars and yard arms became working derricks for hoisting cargo and swinging it aboard. It is from such nautical beginnings that terms like 'luff' and 'slew' and others like 'mast' and 'brace' have been adopted into the language of the crane engineer. So long as the triangular base of the derrick crane is securely anchored to the ground at the points (a) in Fig. 3, the derrick is a very rigid and sturdy crane. It is still found in stonemasons yards, timber yards and on modern building sites at low levels. By mounting each corner of the triangular base on rail trucks, ballasted with pig iron or concrete slabs, the derrick becomes mobile and can be shifted across the building site bodily.

Because of the simplicity of its open structure and its inherent stability, the derrick crane is a popular feature in many of the Meccano Manuals of Instructions. Fig. 4 shows a simple type of foundry derrick crane modelled in Meccano for use in a fixed position on a wall. The jib has a fixed radius and is designed to slew over a fixed arc carrying a bucket of molten metal with no fear of a collapsing jib.

Despite its versatility, the derrick crane has a serious disadvantage in certain circumstances and this is illustrated in Fig. 5. The diagram at (a) shows a simple derrick crane with the hook at ground level. When the jib is luffed to the position shown in (b), it is seen that the hook has been raised through a considerable height even though there has been no winding on of the hoisting rope. If such a derrick is luffed at the same time as it is being slewed, for example when loading

Fig. 4. Model of a wall-mounted foundry derrick crane for handling molten metal. The jib is "tied" at a fixed angle for safety and swings through an arc of fixed radius.

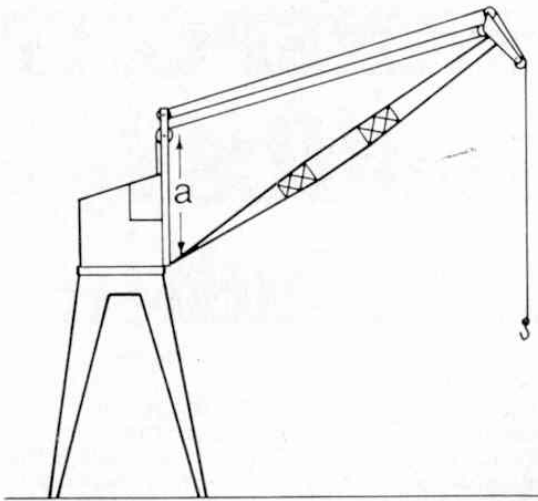

Fig. 6. Diagram of a dockside crane employing Toplis level-luffing gear. Note that the hoisting rope is continuous throughout and constitutes a 3 : 1 Pulley system to compensate for the luffing movement of the jib giving a level position of the load over a wide range of jib angle.

ships' holds at the docksides, a dangerous change in the level of the load could occur. To combat this tendency, a simple but ingenious method of maintaining the load at the same height during luffing operation was introduced and is known as the Toplis Level-Luffing Gear. This is illustrated diagrammatically in Fig. 6 which shows the outline of a level luffing crane. For clarity, no ropes or mechanisms are shown for raising or lowering the jib and the ropes appearing in the diagram are concerned with load hoisting only. In fact, it is a single rope which is shown and it is in the reeving of this hoisting rope over the pulley system that the level luffing principles lies. As long as the jib is not being raised or lowered, any length of hoisting rope paid out from the winding drum will result in an equal fall of the crane hook. When the winding drum is stopped and the jib is raised however, the pulley system (in this case with a 3 : 1 ratio) allows the hoisting rope to run back over the jib head and thus maintains the hook at a constant height. The distance 'a' between the lower end of the jib and the top guide pulleys is critical and bears a direct ratio to the length of the jib of approximately 5 : 16. Although the diagram shows the hoisting rope guide pulleys set one above the other, in practice they would normally be side by side on the same spindle but for clarity of the reeving arrangement they are drawn as shown.

It is not really very easy to visualise this compensating action in the abstract and it is therefore very interesting and instructive to make a model of a crane employing the Toplis Level-Luffing Gear and such a model is illustrated in Fig. 7. As a refinement, the jib pivot has been made adjustable over a wide range so that variations of its position can be made in conjunction with observations of the range of jib angle over which the load can be made to remain at a constant height. It is important to remember that, when making these observations, the winding drum for the load must be left untouched and only the luffing crank should be turned. When the critical point for the lower end of the jib has been found, the degree of level luffing obtained is quite surprising, departing from the ideal only at the extreme limits of jib lowering.

Because of the single rope simplicity of this type of crane, it is very useful for the rapid handling of light loads at the docksides, etc., but where a more powerful

Fig. 7. Demonstration model of a Toplis Level Crane. The long "foot" at the base gives stability to the model and provides a level platform for observing the constant level of the load when the jib is luffed.

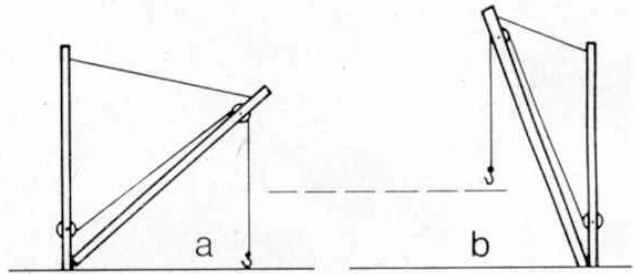
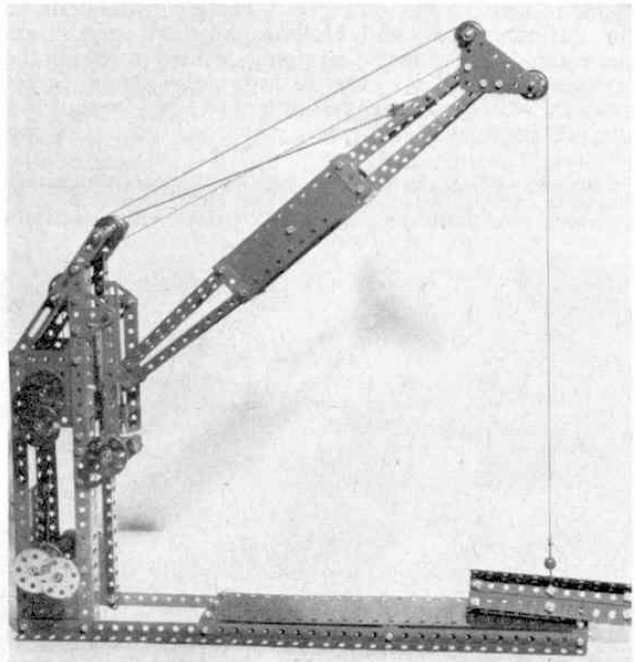

Fig. 5. If two derricks of identical jib length are luffed at different angles without change of the winding drum, the hook will rise through a considerable distance.

crane is required, the problem of level luffing may be solved by the geometrical arrangement of the jib structure. Fig. 8 shows a very efficient luffing system in Meccano in which the principle of a pivotted parallelogram is employed to cause the tip of the fly jib (from which the final hoist rope is suspended) to maintain a constant level above the ground. Such a system lends itself very easily to counterbalancing so that very little power is actually required to operate the mechanical luffing movement and a small economical motor can be employed for the job. This mechanical linked system also has the advantage that no maintenance or replacement of luffing ropes is required.

To be continued next month.

An additional illustration to Fig. 7 and an illustration Fig. 8, referred to in the text will appear in the next instalment which will continue on the subject of BASIC CRANE STRUCTURES.



Meccano Constructors' Guide

Part 3
(continued)

by B. N. Love

Basic Crane Structures

Crane safety is a most important aspect in crane construction whether a simple pulley block or giant Hammerhead Crane is in use. Safe working loads and the inspection of all running gear, brake drums, etc., is vital, of course, but the basic design of the crane must always ensure stability and strength. However,

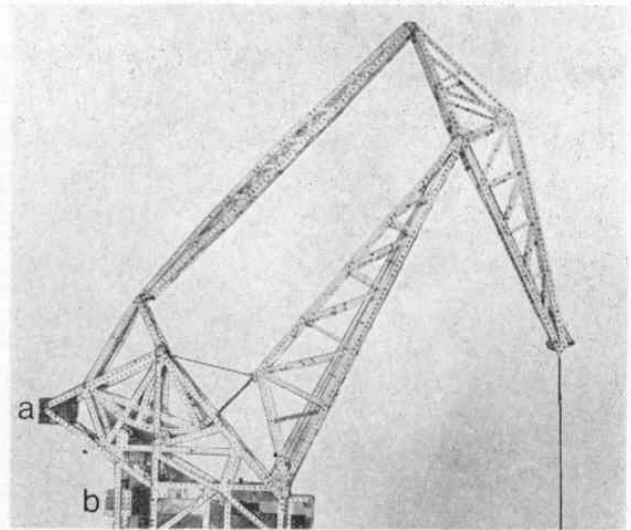

Fig. 8. The jib system of a level-luffing crane in which the linked jib method is employed. Note the parallelogram form of the geometry and the sliding counterweight at (b) which keeps the entire luffing system balanced.

as economy of materials and weight must always be considered, the combination of sound engineering principles must be applied to finding the compromise. The accompanying illustrations give some idea of the way in which Meccano cranes can be constructed to follow sound lines in accordance with their prototypes.

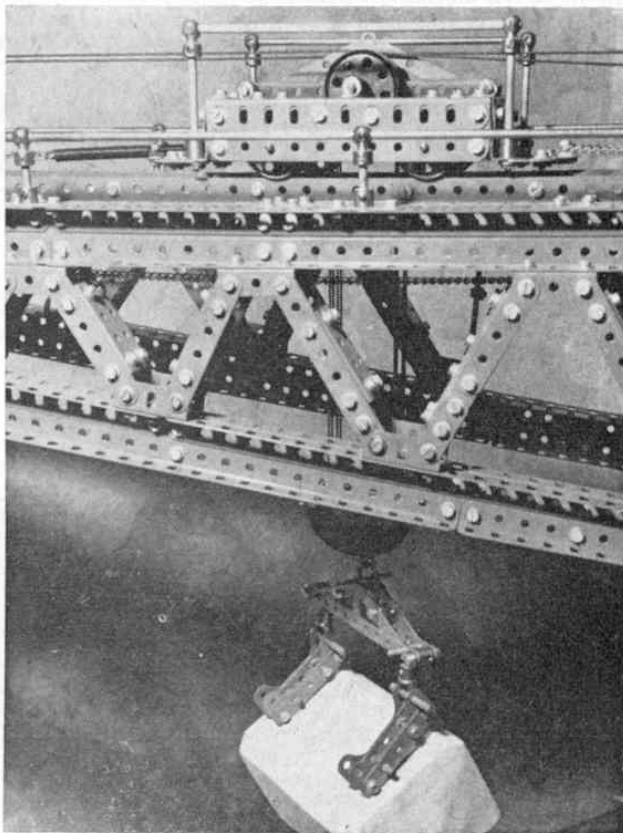

Fig. 12. Typical features of a sturdy Blocksetting Crane. Note use of Triangular Flexible Plates, in several thicknesses, to reinforce the joints of the Portal legs. The boom girders are of heavy section and carry a very robust travelling "crab" capable of supporting the weight of the stone block, etc.

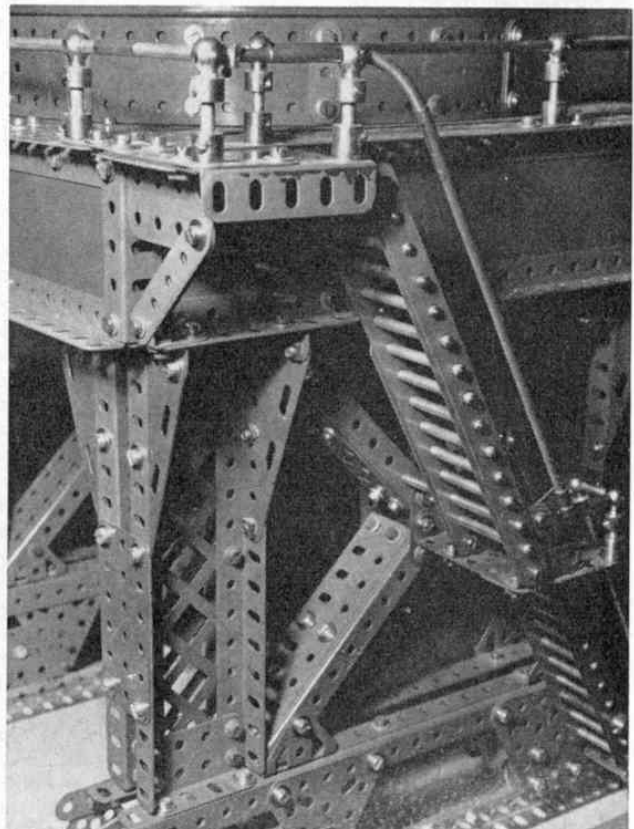

Fig. 9 show a simple but very strong crane tower in which the rigidity of the corner Girders is reinforced by the bracing qualities of Perforated Strips and the use of triangulation is well exploited.

Fig. 10 shows the base of a free-standing structure for a Monotower crane in which compound girders, similar to those discussed in Chapter 1, are used to reinforce the base of the tower and to support the heel of the crane pivot post which runs down through the centre of the tower and takes the entire downward thrust of the whole crane revolving structure. As can be seen in Fig. 10, the central 'H' girder taking the thrust at the base is fitted with a pad of small Flat Plates on which a Bush Wheel is mounted and to which a Socket Coupling is attached. The heel of the pivot post carries a Bush Wheel or similar component, the boss of which enters the upper socket of the Socket Coupling for a short distance where it meets a Meccano Steel Ball resting in the upper socket. The result is a highly efficient rotary thrust bearing which permits the superstructure of the crane to be rotated with ease and a minimum of power.

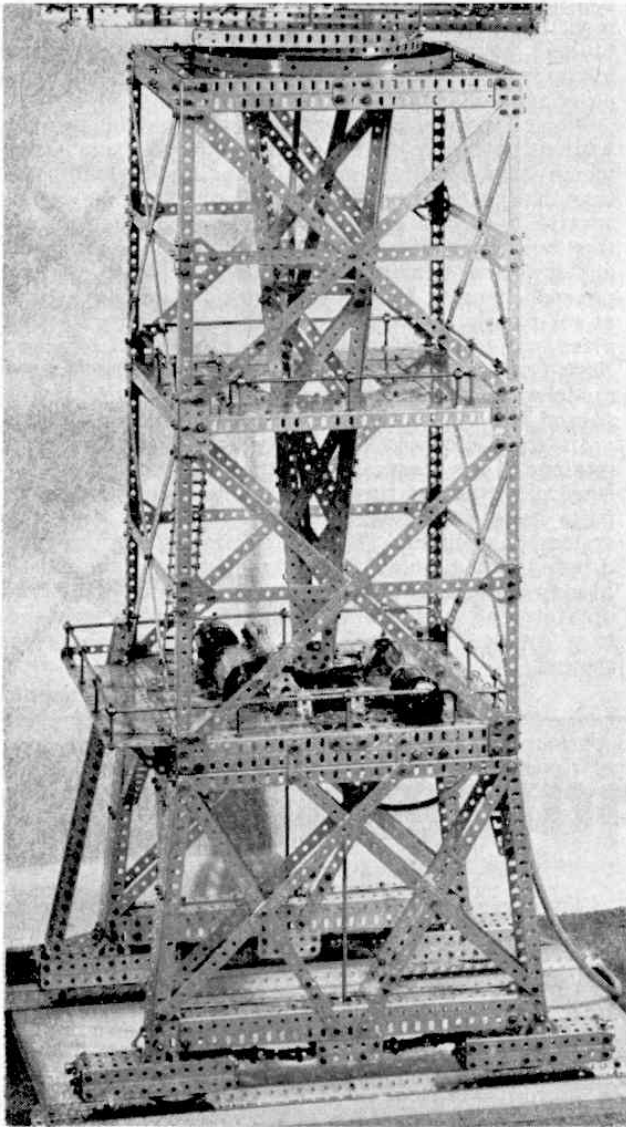

Fig. 9. A good example of an elegant, but strong tower construction for a high-reach dockside crane. Triangular bracing is well exploited as also are the rigid properties of Angle Girders.

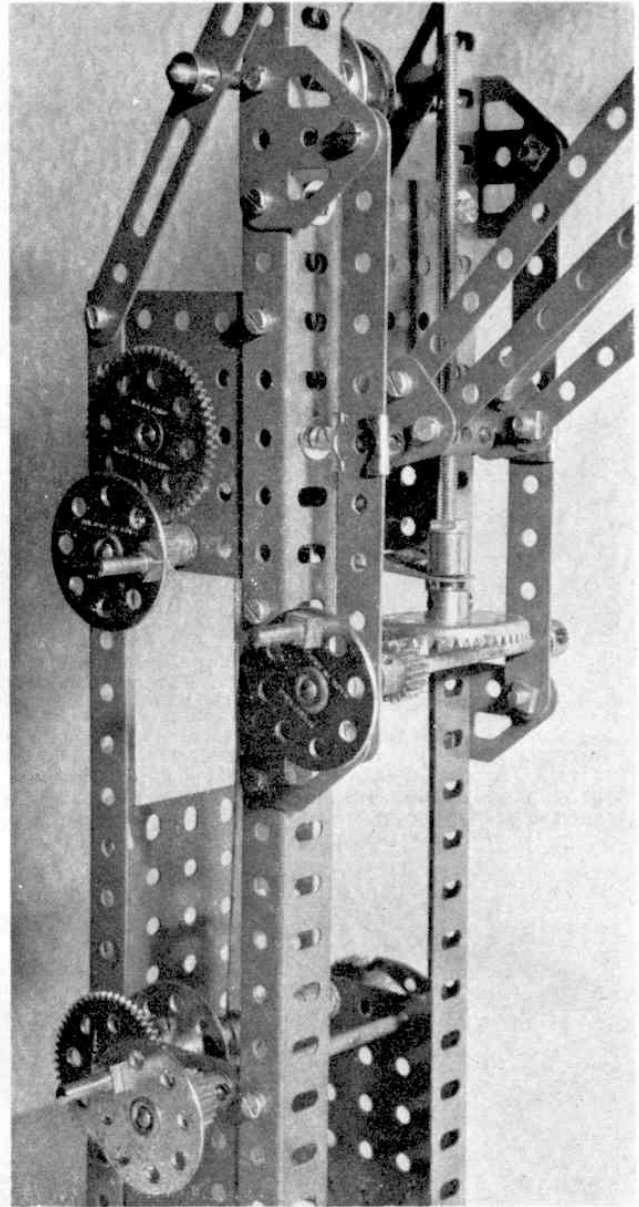

Fig. 7a. Close up of the operating mechanisms of the Toplis Crane. The top handwheel is for luffing the jib, by a simple cord and pulley system. The handwheel at front centre drives a screw mechanism for adjusting the pivot point at the lower end of the jib.

Having secured adequate strength with due regard for overall weight, stability of the crane is of importance. This means that when the crane is hoisting its heaviest safe working load at the extremity of its reach it must never be in danger of toppling over. This safety factor is achieved by making sure that the crane is adequately counterbalanced by placing ballast weights in an appropriate position. Referring back to Fig. 8, a sliding counter-weight is arranged at position (b), its sole purpose being to balance the parallelogram jib system for power economy in jib luffing. The fixed counter-weight at (a), however, is a ballast box (loaded with scrap lead in the model) to balance the working load of the crane proper.

Fig. 11 shows another method of counter-balancing commonly used on Tower cranes where the ballast box is fitted to a cantilever beam supported by long stays from the top of the crane's central mast. For

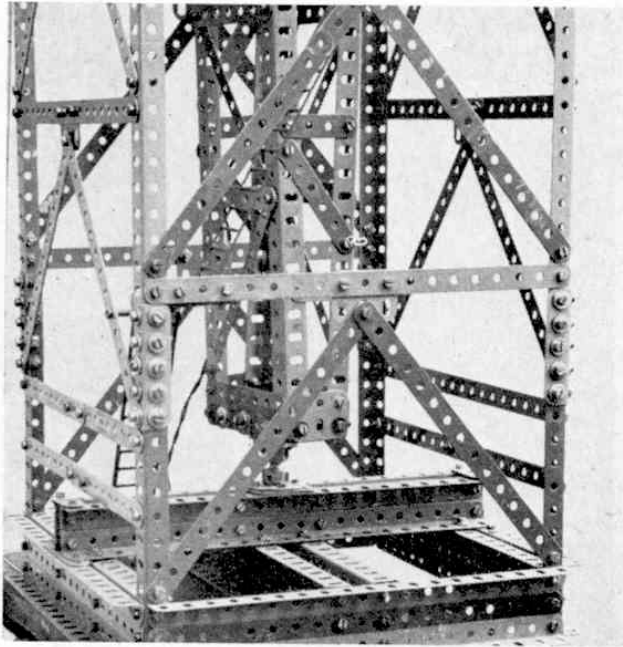
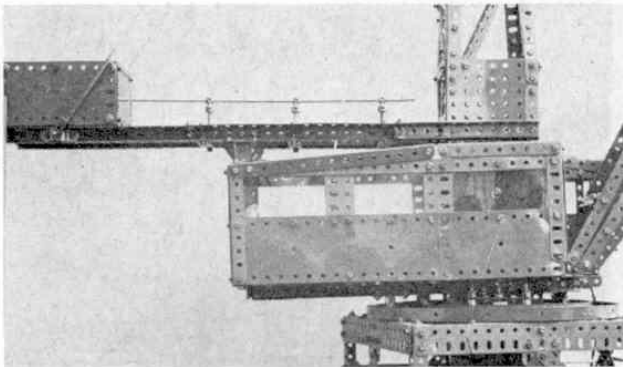

Fig. 10. Above: Base of a free-standing Monotower Crane heavily reinforced with compound girders to take the entire downward thrust of the crane's superstructure on a simple ball bearing.

Fig. 11. Below: Counter balance ballast box typical of that employed on Monotower Cranes. Note that side thrust rollers only are employed in the turntable.



model makers, in the absence of suitable scrap lead, the ballast may be provided by spare Meccano Strips, Plates, Washers and Nuts & Bolts, the use of which makes the ballast adjustment very simple. In calculating safety factors of the nature outlined, the crane engineer must also take wind speeds into consideration and stresses on the hoisting gear and crane stability which could arise through operator errors.

In the last two types of crane mentioned, the revolving superstructure has been carried on a strong centre post made of Angle Girders cross braced with strips which pivots inside the crane tower and is an ideal method of slewing such cranes as no heavy turntable is required at the upper level, a light-duty side thrust roller race being all that is required.

The types of crane which the Meccano enthusiast can model are legion and hundreds of examples of them are to be seen all over the country whether inland or at seaports. Mobile cranes form a class of their own although the principles outlined are as important for these as for any other class of crane. The gantry crane is another very popular type which is very well covered by the Meccano Manuals of Instructions and since it is virtually a travelling bridge its inherent stability is a built-in feature allowing it to cope with the greatest loads, weight for weight, by comparison with any other type of crane.

No mention of crane structures would be complete without reference to the Giant Block-Setting Cranes which have featured in Meccano literature for more than half a century. Very few of these juggernauts survive to-day as the breakwaters and harbours which they built over the past century are now well established and modern construction utilises pre-cast, or site-poured concrete by contrast with the fifty-ton blocks of solid masonry which these veteran 'Titans' set into place with precision of a trained eye and a steady nerve. Such cranes are fascinating challenges for the Meccano modeller and Fig. 12 shows some aspects of their rugged structure which may be reproduced in Meccano.

In the following chapter we shall be considering motions of the crane, in particular the hoisting mechanisms and types of turntables. The range of Meccano parts is so vast by comparison with any competitive system that highly efficient turntables and powerful drives to them may be constructed from the existing Meccano range without resort to purpose-made parts or 'foreign' bodies and diameters varying from 1 in. to a couple of feet are well within the scope of the system.

Part 4—Winding Gear

NO MATTER to what size a model crane is made, the greatest satisfaction to the modeller comes when it springs to life with the first movement of its winding drum. The simplest form of ready-made winder in the Meccano system is the Crank Handle which is found in all Meccano Outfits from the smallest to the largest and with the simple set-up shown in Fig. 1. it is perfectly efficient. At one time, younger modellers had some difficulty in securing the hoisting cord to the Crank Handle, as simple hitches and knots gave no real grip, but with the introduction of the Cord Anchoring Spring, Part No. 176, a positive grip was assured.

Two points are worth noting with regard to the use of this part as a cord anchor. It is important that, when the winding handle is turned, tension come on to the small loop arm of the Anchoring Spring in such a way as to tend to wrap the Spring more tightly round the shaft as the load is hoisted. Fig. 1 shows the Cord Anchoring Spring correctly set for hoisting with a clockwise motion. Before attaching the hoisting cord to the Spring, the cord should first be tied with a half-hitch round the shaft and its 'tail' secured to the small loop on the Spring. This prevents 'snatch' when the hoisting cord has run out to its fullest extent.

For younger model-builders, the process of fitting a

Cord Anchoring Spring to a Meccano Axle Rod or Crank Handle can present something of a difficulty, as a twisting motion on the Spring is required to make it open its coils very slightly to accommodate the shaft diameter. This is made very simple by first locking a Bush Wheel or Pulley on to the shaft and trapping the loop of the Anchoring Spring with the thumb. The shaft may then be twisted into the Spring, using the Bush Wheel to apply the twist in such a direction that the Spring tends to unwind (very slightly) as it is pushed on to the shaft. The moment that the Spring loop is released, the whole Spring will grip the shaft very tightly. The greater the pull of the winding cord on the loop, the stronger will be its grip on the shaft. Fig. 2 shows the method of adjusting the position of the Cord Anchoring Spring on an Axle Rod.

With just a few parts, a rugged and realistic winch can be constructed such as the typical two-handed donkey winch shown in Fig. 3. This may be incorporated in hand-operated derrick cranes or mounted on low-loader trailers for winching heavy loads aboard and is very simple to make. A novel feature of this winch is the use of the slotted holes in the two Triangular Plates forming the frames. As can be seen from the illustration, a 15-teeth Pinion is meshed with a 38-teeth Gear Wheel giving a gear ratio of approximately $2\frac{1}{2} : 1$ which is very useful and gives a nice scale speed of wind-in. End checks for the winding barrel are provided by an electrical Bush Wheel (Part No. 518) at one end, and at the other end two $\frac{3}{8}$ in. Washers which are free to ride against the 38-teeth Gear Wheel and thus prevent chafing of the cord by the gear teeth. The small Bush Wheel provides splendid anchorage for the cord. The two side frames are braced apart by 3 in. Threaded Rods, lock-nutted as shown. Further realism may be added to the winch by providing a Pawl and Ratchet, Parts Nos. 147 and 148, fitted to the side frames.

Despite the simplicity of the Axle Rod as a winding drum, it has advantages even in advanced models. Its narrow diameter gives a very fine control of hoisting so that critical adjustments for such things as the tripping rings for a single-suspension bucket grab can be made with precision, while auxiliary hoists in large models can be nicely scaled with small winding drums. In engineering practice, wire ropes are used extremely extensively in all kinds of cranes, excavators draglines, etc., and are often of a very generous size to take strains of hoisting, luffing, winching, etc. Such ropes run more efficiently, with less wear and internal friction, if they are not bent to a sharp radius round a narrow diameter winding drum.

The Meccano system lends itself well to the construction of larger winding drums by making use of the standard cylinders available. These are illustrated in Fig. 4 and figure quite frequently in published models. The standard shaft fitted with electrical Bush Wheels, by the way, may be augmented by mounting one or two Couplings on the shaft to give a small increase in diameter, and a variety of end cheeks for these parts is available in the shape of Bush Wheels, Flanged Wheels, Face Plates, Sprocket Wheels, large Gear Wheels and the Circular Plates. Such end cheeks have the advantage of perforations through which a heavy hoisting cord can be threaded to be secured on the outside, as shown in Fig. 5. In this illustration a Rod and Strip Connector forms a 'Thimble,' in the throat of which a spliced or whipped loop at the inner end of the hoisting rope is seized. A Washer ensures a sure grip for the actual loop. In simple models, however, the cord can be passed through two holes of the end cheek and knotted internally, as shown in Fig. 3.

Winding capacity for two of the drums illustrated in

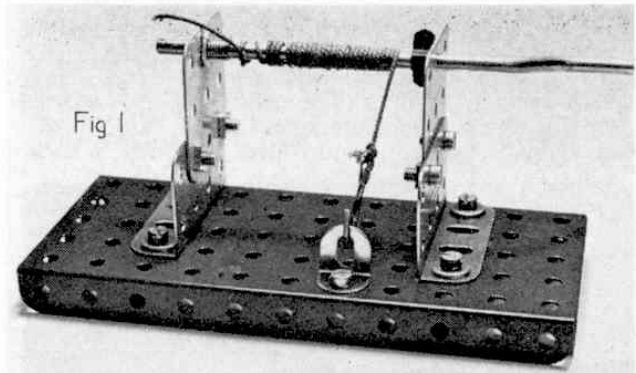

Fig. 1. The most simple of all Meccano winding equipment, the Crank Handle, seen here fitted with a Cord Anchoring Spring.

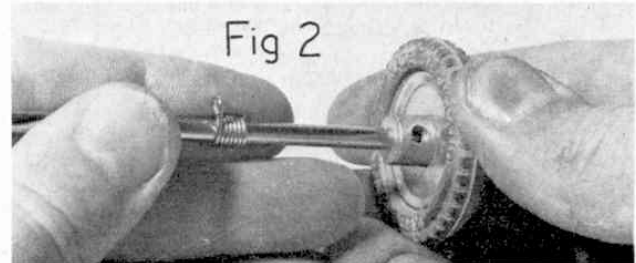

Fig. 2. A simple method of positioning the Cord Anchoring Spring on an Axle Rod with the aid of a Pulley and Tyre.

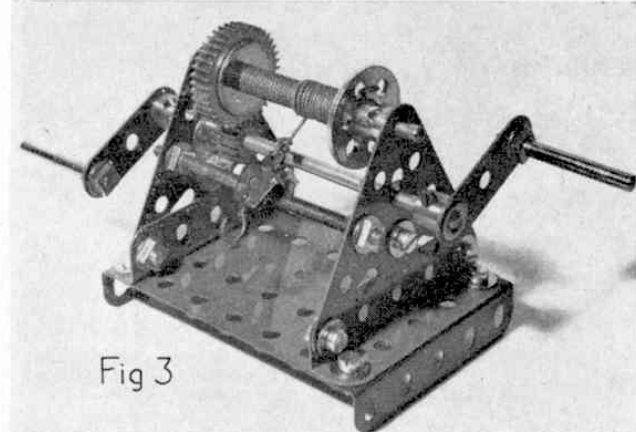

Fig. 3. Two-handed donkey winch. Note non-standard spacing of gears making use of the slotted holes in the triangular side plates.

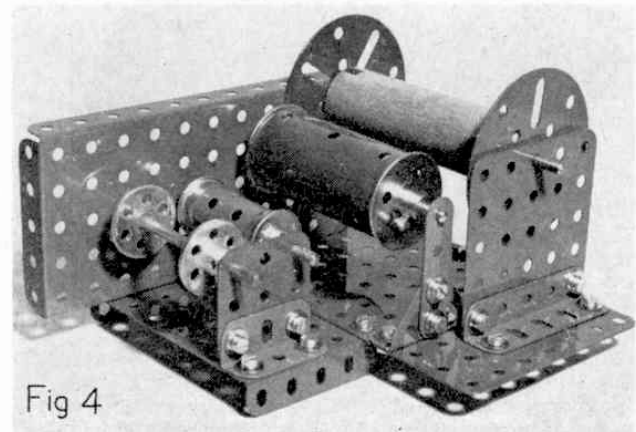

Fig. 4. A selection of Meccano winding drums made from standard cylindrical-shaped parts.

Fig. 4 can be improved by adding end cheeks as shown in Fig. 6. Normally the Sleeve Piece seen here is centralised by small Flanged Wheels fitted externally, while the 2½ in. Cylinder is centralised by large Flange wheels fitted internally. The Sleeve Piece is carried on internally-mounted Chimney Adaptors, Part No. 164, and the end cheeks are provided by Bush Wheels.

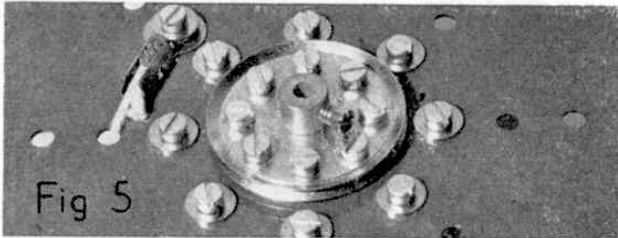

Fig. 5. A method of securing a heavy-duty winding cord to the outside of a winding drum. Note the use of a Rod and Strip Connector as a "thimble".

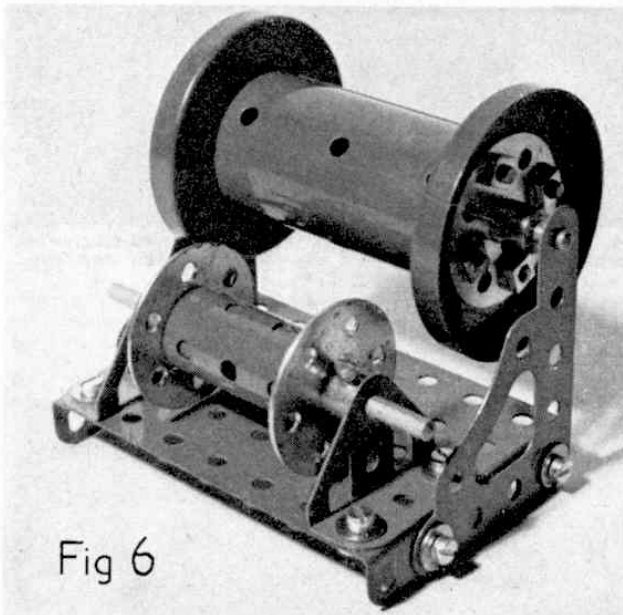

Fig. 6. Improved versions of winding drums, the smaller made from a Sleeve Piece and the larger from a 2½ in. Cylinder fitted with bigger end cheeks.

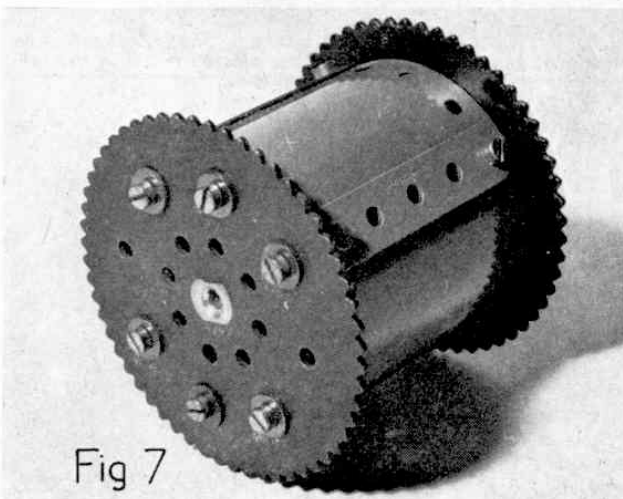

Fig. 7. Large-diameter winding barrels can easily be built-up from curved Flexible Plates. Note the use of heavy-duty end cheeks, supplied by Sprocket Wheels in this case.

Construction of end cheeks for the 2½ in. Cylinder is a little more involved. Four 3 in. Threaded Rods are each fitted with a Nut and Washer, then are pushed through four alternate holes of an 8-hole Bush Wheel to bring them into register with the four holes punched in the Wheel Flange, Part No. 137, illustrated. Each Threaded Rod is then fitted with two Anchoring Springs for Cord, which will slide over the threads of the Rods quite easily, these Springs simply acting as spacers to take up the 'slack' in the circumference of the 2½ in. Cylinder, which is next passed over the four Threaded Rods. When the second Wheel Flange and 8-hole Bush Wheel are lock-nutted into place, the Cylinder is tightly held concentrically between the end cheeks. If necessary, the hoisting cord to be wound on this reel can be secured by a Washer and Bolt through one of the perforations in the Cylinder.

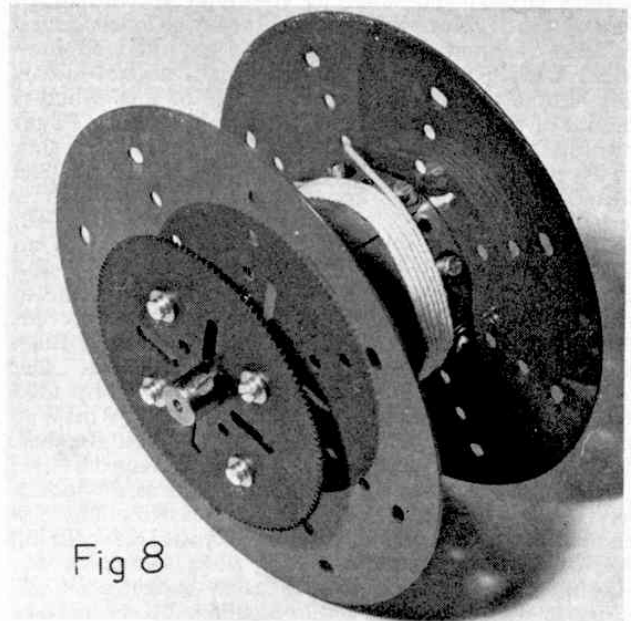

Fig. 8. A "deep-throated" winding drum for a colliery winding engine or large model dragline. The driving gear is bolted directly to the drum for rugged drive.

If longer Threaded Rods are used in the construction of the latter drum they may, with advantage, be passed through the holes of one of the larger Sprocket Wheels or Gear Wheels to provide a very positive drive.

Some drum drive arrangements require a slow-moving, large-diameter barrel, and this is readily achieved in standard Meccano parts by using 2½ in. × 2½ in. Flexible Plates, Part No. 200, which are already curved to the form required. Fig. 7 shows a drum built up from these plates and mounted between two 3 in. Sprocket Wheels internally fitted with four, six or eight Threaded bosses, Part No. 64. The transverse tapped bores of the Threaded Bosses are used for securing the four Curved Plates required at four points spaced at 90° round the drum. The remaining two or four Bosses in each end cheek act as bearers to accommodate the curvature of the Plates. The slotted holes in the Curved Plates lend themselves very well to cylindrical adjustment of the drum, but, for strength and appearance, these are overlaid with 2½ in. Perforated Strips.

The "Plate technique" can be applied in making specially-large drums for colliery winding engines or large models of heavy draglines, as shown in Fig. 8. Again, a driving gear is attached directly to the 6 in.

diameter Circular Plate acting as the end cheek so that a very rugged drive can be applied to the drum. If the far cheek is fitted externally with a Circular Girder, Part No. 143, a large-diameter brake ring is available for a heavy-duty contracting brake. Such a drum would accommodate several hundred yards of heavy-duty cord such as that used for off-shore sea fishing lines. A medium-size drum can be made on similar lines using the 4 in. diameter Circular Plate. Although Fig. 8 shows securing Bolts fitted to each anchoring point supplied by the Threaded Bosses beneath the Plates, alternate Bolts may be removed after the joins in the Curved Plates have been secured.

Just to give some idea of the versatility of Meccano parts in coping with any model from the humble to the mighty, Fig. 9 shows a winding drum of no less than 9½ in. diameter! Although a rather unusual requirement for a model, the method of rotating the drum will be of particular interest to advanced model-builders since it employs one of the oldest systems of gear drives, i.e. peg teeth. The 167b Flanged Ring is fitted with eight sections of 4 in. Curved Strips, each fitted with $\frac{3}{8}$ in. Bolts and Nuts. The drive comes from a 6-hole Bush Wheel fitted with short Threaded Pins which impart a surprisingly smooth motion to the large drum.

Brake systems for model cranes are featured frequently in Meccano Manuals and literature and many of them have been quite ingenious. Fig. 10 shows two simple, but very effective brakes which are the essence of simplicity. The left-hand section shows a slip brake comprising a weighted lever arm fitted to a Double Arm Crank mounted on a Pivot Bolt, about which it is free to move. One arm of the Crank engages in the "V" slot of the 1 in. Pulley which would be fitted to the winding drum or gearing. A 2½ in. Driving Band applies tension to the brake lever which may be adjusted by shortening the rubber band with short loops over the two Bolts between which it is stretched. Such a brake is normally in the "on" position so that it is necessary to raise the lever to allow the 1 in. Pulley to 'slip'.

The right-hand arrangement in Fig. 10 shows a very simple but versatile brake capable of immediate adjustment both for tensioning and for application. The brake lever is a 4 in. Axle Rod fitted with a Handrail Coupling for a handle and it is pivoted on a Short Coupling half-way up the side plate of the crane gearbox. The lower end of the brake lever carries a Slide Piece, Part No. 50 which rubs against a Tension Spring, Part No. 43 and is thus held in any desired position. A Threaded Pin attached to the side plate acts as a simple stop for rearward movement of the brake lever. The brake 'shoe' is another Slide Piece which embraces the tread of a 1 in. Motor Tyre, Part No. 142c when the brake lever is set to the "on" position. As shown, the position of the Slide Piece ensures absolute locking of the Motor Tyre in the clockwise direction and will hold a winding barrel, to which the brake is fitted, against any normal load. Adjustment of the Slide Piece up the brake lever will give finer degrees of braking. Additional tension may be applied to the movement of the brake lever simply by stretching the Tension Spring to a wider anchorage or by lowering the bottom Slide Piece. Other sizes of Motor Tyre and Pulley can be worked satisfactorily with this design which, despite its simplicity, is very efficient.

Fig. 11 shows a specimen crane gearbox in which simple brakes are fitted in the form of loops of cord passe around Pulleys and held in tension by counter-weighted brake levers. This method is quite effective as a simple brake and may be applied satisfactorily in

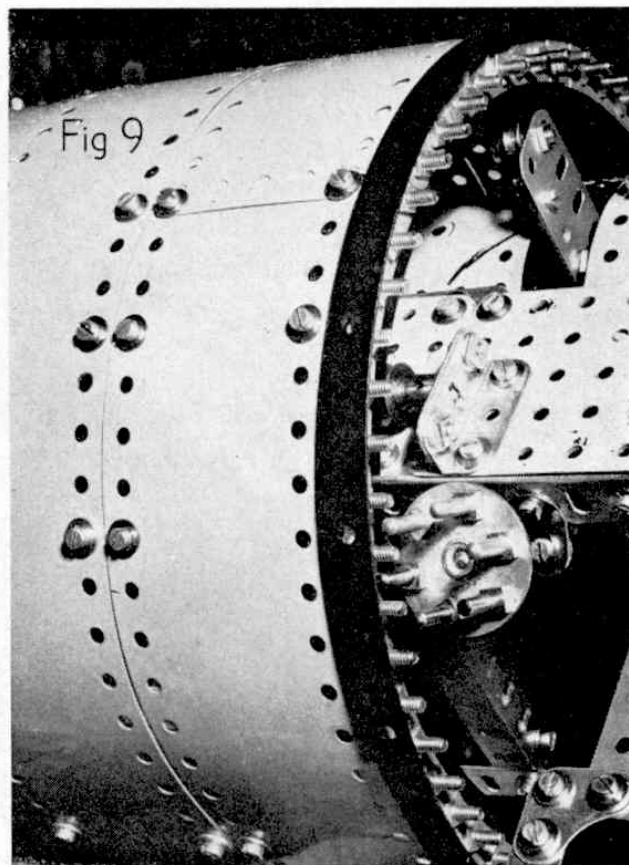

Fig. 9. This giant winding drum is driven by one of the oldest gear principles known—peg gears. In this case the pegs are supplied by Bolts and Threaded Pins.

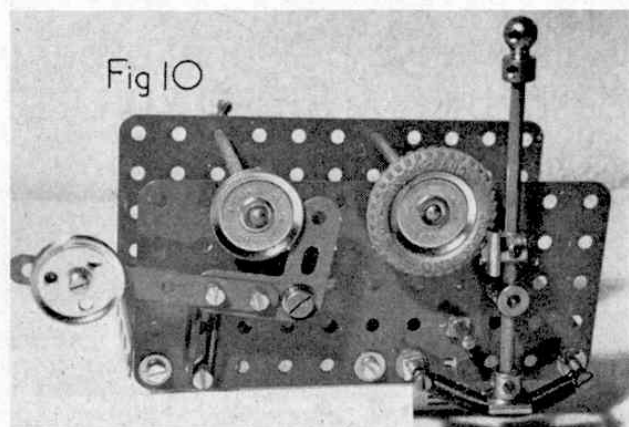
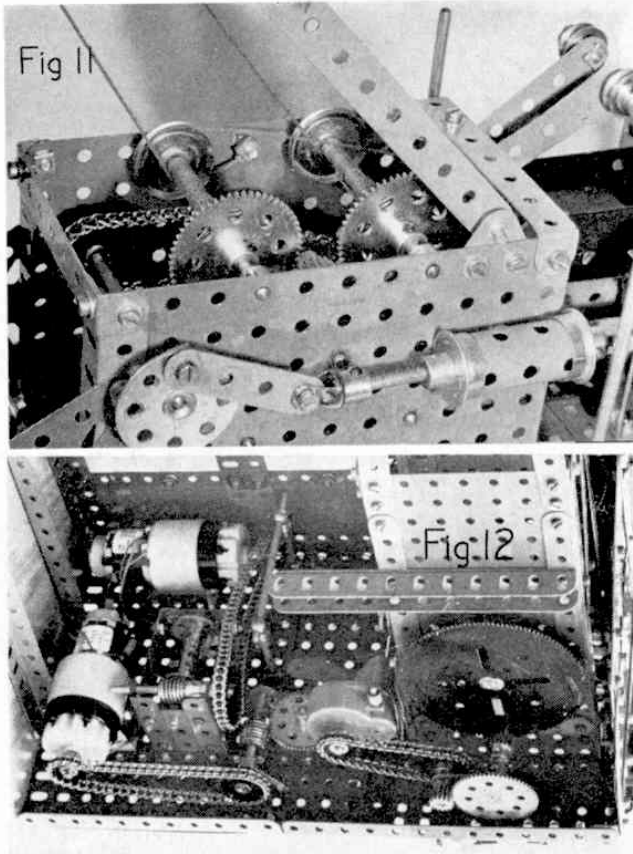

Fig. 10. Two simple but effective brake systems for winding drums. On the left is a "slip" brake. On the right a versatile positive-lock brake capable of fine adjustment.

smaller models. However, it has the disadvantage that cord tends to stretch rather easily and a vigorous release of the brake lever can throw the cord loops off the pulleys.

In contrast to Fig. 11, which shows a gearbox feeding four different movements from one shaft, Fig. 12 shows the neat control cabin lay-out of a model Monotower Crane. The use of individual power units is quite striking and is well in accordance with modern crane-building practice, although at one time it was customary to install a very heavy power plant in large cranes which



drove all of the movements by means of lengthy shafts, masses of gearing and flexible couplings. Power losses were considerable under these circumstances, but, in the days of cheap coal and lack of smaller high-power units, this was no great problem. Many veteran Meccano modellers enjoy reproducing the earlier models of such cranes, but the modern Meccano D.C. Motor with 6-ratio gearbox gives the enthusiast tremendous scope for placing his drive exactly where he wants it. This means that each unit is supplying the correct power for its individual job, with minimum power-loss, through extended shafting, and, of course, with worm drives to the movements, as shown in the illustration, braking problems do not arise to the same extent as would be in the case of winding drums and other movements being dependent upon clutch linkages. Individual electric power units have the advantage of small size, internal gearboxes and remote-control, thus reducing operator fatigue and making the crane available from ground control. The Meccano Constructors' Guide is not intended to give comprehensive coverage to the topics outlined in this Chapter, but the enthusiast will find a rich source of material on crane gearboxes and movements both in pre-war and post-war Meccano Magazines, due to the tremendous popularity of cranes as models throughout the history of Meccano.

Chapter V will be dealing with swivels and turntables for cranes and other similar machines and will include a complete built-up roller bearing making use of the new Meccano Large-toothed Quadrants and special Pinion.

Fig. 11. Cord brakes fitted to an early Meccano Breakdown Crane. Fig. 12. Individual electric power units in a model of a modern Monotower Crane. Note the small winding drums made from Couplings, and the Worm drives to the movements.

"STARDUST FORTUNES"

An amusing personal experience
described by RICHARD LEE

IN THIS COUNTRY, seeing what the stars hold for us in the horoscope columns provides a form of amusement or light escapism. In the East, however, the telling of fortunes by Astrology is not only big business—it is a very serious business also. In India, where even today most marriages are arranged by the parents of the prospective brides and grooms—who often see each other for the very first time at the actual wedding ceremony—the most important part of the arrangements concerns obtaining horoscopes of the intended couple in order to see whether these horoscopes forecast similar futures for the pair. Sometimes the horoscopes will differ, perhaps forecasting that the groom is destined to go overseas, and the bride may be forecast never to leave her native shores. In circumstances such as these the marriage is invariably 'off'—for what would be the use of such a union if it has to be spent apart?

Eleven years ago, when I was in India as a single man, I scoffed at the idea that Astrology could accurately foretell the future. I was warned by an Indian colleague not to be damning in my attitude without first giving it a trial. I agreed to this and he undertook to get me a 'pukka' horoscope. I had to pay 25 Rupees (about £2.0.0) for it and also to wait about three months for its arrival. When it came in the



post from the Indian Astrological Research Institute, from Kodakara in Travancore State, I was impressed at once by the trouble that they had taken over it. It was in the form of a bound book with 46 typewritten