

# BATTLE

## Part X—Anti-Tank Guns —The Final Points

by Charles Grant

WHEN CALCULATING Defence Values for our tanks and so on we used as a basis a single thickness of armour, a figure derived mainly from the maximum armour thickness as given in the appropriate specifications, but which, in practice, would really amount to an average sort of thickness. In turn, this logically produced an average sort of Defence Value. It would be a simple matter to take this as a constant, but this would tactically speaking be a terrific unfair, as I hope to show, taking an ordinary example to do so. This involves the use of the 'bazooka', an infantry ambush weapon, although it can also apply to any vehicle armed with a gun. A lightly gunned tank, for instance, if it is going to take on a stronger and more heavily armoured opponent, is not going to take the bull by the horns and meet it head on, but is going to lurk about and wait for the opportunity of slamming home a shell into the weakest part of the enemy. This kind of tactics is particularly applicable to infantry bazooka teams and of course the "panzerfaust"—where the use of the weapon immediately gives away its position and in whose case the first shot must really strike home. Or else! So, what does the bazooka team do? It does not fire at the front or even the side of an advancing tank, but waits until it has passed, when it endeavours to send home a shot into the more vulnerable portion of the enemy's metal anatomy, the rear.

In fact, although we did allocate a single Defence Value for each tank or other armoured vehicle, this indeed must vary with the three aspects we have to consider—front, side and rear. The proportion of armour thickness varied from tank to tank, but if we take the German Mark IV as an average sort of example, we find that the thickness of hull armour was thus:—front—50 mm., side—30 mm. and the rear—20 mm. The turret armour was more or less the same, except that the rear thereof was 30 mm. instead of the 20 mm. of the hull. In effect, what we can say then is that the Defence Value of the front of the tank is, or should be, higher than that of the side, which in turn is higher than that of the rear. In the case quoted we can ignore the fact that the turret rear armour is the same as that of the side—the hull aspect is considerably greater than the turret's. What all this amounts to is that, although we could use the Defence Value as given in the Table for all cases—this would be simple—it won't really be a great deal of trouble to make allowance for difference in armour thickness and

we do this in a very simple way. When a tank has been hit we consider the Defence Value in relation to the position of the strike—if the side is involved, the standard or given Defence Value is used to decide whether the strike has been effective or not. So, when the shell has hit the front of the target tank, we add 1 to its Defence Value, and when, happily for the 'general' who has caught his opponent at a disadvantage, the rear has been assailed, a deduction of 1 is made. Just one example to make this clear—if this has not already been done—the Sherman, with a D.V. of 14, if hit in front, adds 1, and if hit on the more lightly protected rear, loses 1, making the Defence Value only 13.

### Hit determination

So far, so good, but we have to determine which part of the tank has been hit by the shell—if at all, of course. This is easy. Just take a direct line from your gun muzzle to that portion of the enemy you want to have a go at—this process giving us the opportunity of demonstrating our first 'Battle' device, this being a very elementary one indeed. The player can have recourse to a tape measure—the metal type is satisfactory for simple distance or range computation, although it does tend to whizz back into the holder at the slightest opportunity. Myself, I use a species of home-made straight-edge, in fact a length of  $\frac{1}{4}$  in. half-round wooden beading. In fact, I have a number of them of different lengths, for in the heat of an engagement it's quite easy for a single measure to disappear, to turn up under the table some time later, and if a number of 'sticks' are lying about, the player can conveniently grope around for one, while keeping an eye on his enemy's activities at the same time! The various sticks can be easily and clearly graduated by painting the flat surface of the beading white and marking on the necessary measurements in black, either by painting or by using a felt-tipped pen, both these methods being eminently suitable.

The first one required, as it happens, is the one used for anti-tank range and it need be only 45 in. in length (as already said, it is not anticipated that we shall use, for the time being at anyrate, longer anti-tank gun range). On this we mark off the distances referred to in our Strike Value Table. Accordingly it is divided into four sections, so, having painted the flat side of the beading white (and let it dry, of course) we mark in the divisions we have decided upon—i.e. 0 in. to 10 in., 10 in. to 20 in., 20 in. to 30 in., and 30 in. to 45 in.

In passing, it is obvious that a simple wire properly marked, or even a piece of string with knots in it to indicate the various ranges, would do the trick, but for one reason which I hope to demonstrate, the stick—which can be  $\frac{1}{2}$  in. in width if the narrower one is found to be too fragile—is really recommended.

### Angle of strike

Anyhow, armed with the suitably calibrated 45 in. stick, the next step, involving a little do-it-yourself work, is as follows, and it concerns the angle at which the shell strikes the armour of the target tank. First of all, the reader doubtless knows full well that a shot striking a surface at right angles to it has a far greater effect than one striking a glancing blow—and the more acute the angle between the direction of the shot and the surface the less will be the effect, and the greater chance there will be of the missile's ricocheting off into the blue. One of the most important and most highly scientific part of tank design is the angle of setting of

armour plate, but it will be sufficient for the purposes of "Battle" if, in the rules, we make an allowance to ensure that the shot which strikes fair and square will have a greater effect than that which strikes at an acute angle.

### Construction

This we can do if we construct a device, which can be elaborate or simple as desired, but which amounts basically to a home made protractor. Get a piece of card—this is really a very simple way of doing the job—and with an ordinary pair of compasses inscribe thereon a circle, drawing in the diameter as well. With a scissors or sharp knife cut out one of the resulting half circles. The size does not matter terribly—it can be 2 in. to 3 in. in diameter, or even a little larger. Then with the aid of an actual protractor draw in the lines showing angles of 30 and 60 degrees, on both sides of the vertical. In effect each right angle has been divided into three equal sections. With this in hand, we can make allowance for the strike angle and this is done by simply adjusting the given Strike Value of the gun firing. This was initially calculated as an optimum—i.e. when the shot had impacted more or less at right angles—and in this case the normal S.V. was used. When, however, it strikes at an angle of between 30 and 60 degrees to the surface a deduction of 1 is made to the Strike Value, and when the angle is less than 30 degrees, the reduction is 2. Lest this be thought to be an exercise in geometry I hasten to reassure the reader. Have another look at the half-circle you made and mark the appropriate sections with '— 1' and '— 2' as the case may be. You will have something like that shown in diagram. This is looked at with the horizontal side uppermost for the simple reason that this is the way it will appear to the player using it.

Now take the graduated stick and down the centre of the 0 in. — 10 in. section draw a straight line, to indicate the exact path of the shell. The semicircular card is now pinned to the extreme end and the final result can be seen in diagram—this being the Tank Range and Strike Angle Stick, which is a dreadful mouthful and instead of which we shall simply say the "Tank Stick". An ordinary pin or fine nail may be used for the job of joining the two component parts, or a small nut and bolt, it does not matter so long as the 'protractor' part is allowed to pivot fairly easily on its spindle. Quite certainly the enthusiast with the requisite time and the necessary skill may desire something a little more substantial than that which I have described, but even with this it might be necessary to reinforce the beading at the swivel point, either with a tiny block of wood, or with a blob of plastic putty. In any case, some care will have to be taken in driving the pin into the stick to prevent splitting, and yet to get it as near to the end as possible. I have no doubt that the ingenious reader will be able to complete the device to a much more elaborate and solid specification than that detailed.

### Using the protractor

Now for its use. The diagram and the accompanying photograph make this pretty obvious, but in brief, when tank "A" fires at tank "B", say, the head of the Tank Stick is placed against the latter and the Stick extended back over "A", when, at practically the same time the range and any required

The "Tank Stick" in use—a 'Sturmgeschütz' having a 'go' at a T.34—the 'Stick' is placed alongside the former for the sake of clarity.

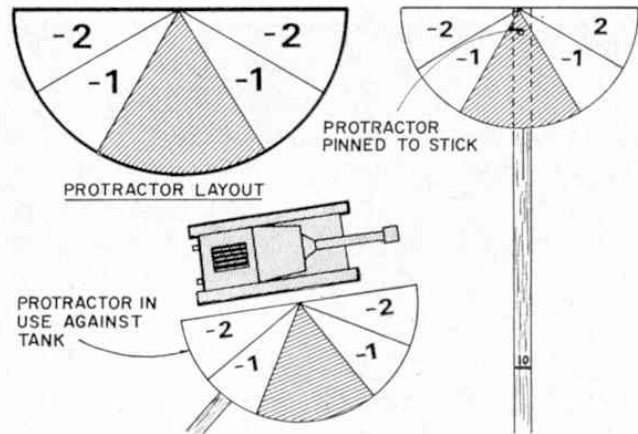

deduction to the Strike Value for angle can be read off. At the same moment it can be seen where the tank has been hit and any alteration to the standard Defence Value noted. This all sounds terribly complicated, but so indeed does the explanation of any sort of simple action, and in practice it takes only a few seconds. It is a remarkably quick process to place the stick in position and do the rapid sums required, then roll the necessary dice.

### An example

Just one example—suppose a German Mark IV with 'long 75' fires at a Sherman at 15 in. range; Strike Value at this range is 6; the deflection was between 30 and 60 degrees, therefore 1 is deducted, making it 5. Defence Value of the Sherman is 14—hit is on the side, so no deductions; two dice rolled by the 'Mark IV' player—he gets a 6 and a 4 making a total, with his Strike of 5, of 15—one more than the Defence Value, therefore—a kill!

And next month, at long last, ACTION!

### Correction

(Note:—In Part VIII of "Battle" (December 1968) reference was made to the "21 possible variations" in the throwing of two dice. I wrote that I was possible to score 11 or 12 in two ways, and 7 or more in 12 ways out of the possible 21. This actually referred to the *apparent* combinations, because there are obviously 36 different ways in which the dice can fall—six times six, in fact. The chances of getting a total of 11 or 12 are actually three out of 36—a possibility of 1 in 12—and 21 out of 36 of getting 7 or more—or one in under two. All this hit me in the eye when I read the published text and I hasten to apologise for my carelessness in using the wrong set of figures.)

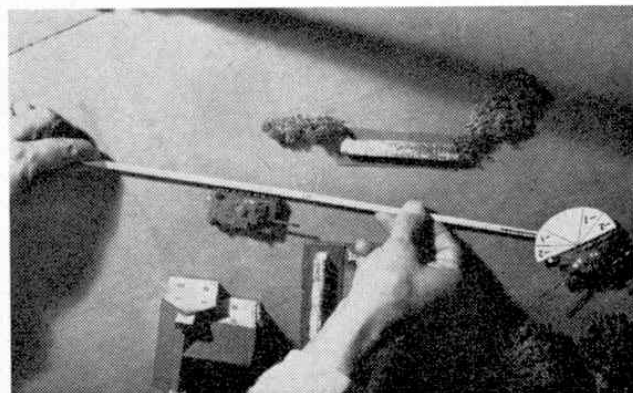

# BATTLE

## Part XI—Armoured Action

by Charles Grant

THE FIRST "active service" we take part in, will of necessity be a fairly simple sort of thing, involving only a few armoured fighting vehicles on each side—a straightforward sort of terrain (you can see what it is like from the diagrams and photographs). The idea is to provide a first illustration of how we go about the business of fighting on the battlegame table. The latter, by the way, for the purposes in mind, is not enormous, and measures 7 ft. by 4½ ft. (or half the size of that which we shall use later on). The ground will be seen to be pretty flat, *figure 1* (the small hills are reckoned to be steep and unclimbable) and its main features are a river, crossed by two bridges, 'A' and 'B', a few small woods, some walls and a couple of ruined cottages. Then there are the roads, of course, which, it goes without saying, are very important. The tactical scheme is similarly without complication—'RED', coming from the east, and 'BLACK' from the west, each has orders to advance and secure the river crossings, the background being that the task forces involved are advanced guards of much larger armies.

As to what we shall actually engage, then, 'RED' has four Russian T.34 tanks—equipped with the 85 mm. gun—while 'BLACK' has four German Mark IV tanks—the variant with the 'long' 75 mm. gun—and two heavy armoured cars, armed with 50 mm. guns.

Just to recapitulate, the technical data relevant to all these is assembled for ease of reference in the Table (Note that the speeds of the Mark IV are additional to what was given in Part III of "Battle"). I include it as much for my own benefit as the reader's—it is designed to save a lot of checking through former articles—as, at the time of writing, the action has indeed yet to be fought. I don't know how it is going to go any more than anyone else. Before we start, though, a quick word about the sequence of events. In a 'game move' each player moves his pieces—tanks, etc.—the distance allowed by the rules (or less, of course), and at the end of the 'moving' his guns will fire, again if he desires, and naturally, only if he has a target within range. Damage is assessed, and that is the end of the 'game move', which consists of a combination of movement and fire. In the present case, we assume that the contending forces are just off the table, and will appear thereon on the first move.

Having thrown dice to establish visibility, and happily having found that it is maximum—that is to say, 30 in. and 45 in. for unaided and aided respectively—we can proceed to dispense with the former, all vehicle commanders doubtless being well supplied with binoculars and so on.

With the task forces ready to come on to the table by their various roads and being in column with, say, a couple of inches between each vehicle, the first in line will be able to make its maximum move from the edge of the table, the others following up as appropriate. So, off we go.

Coming from the west, BLACK, of course, headed his column with the two fast armoured cars, and with an eye to what he considered his own advantage, sent them along the left hand fork—the North Road—while his Mark IV tanks remained in column on the South Road, moving their full 12 in. RED, on the other hand, decided to deploy forthwith, his leading tank sticking to the road, but moving only 6 in., to allow the others to come up as far as possible into a line-abreast formation, two on the right and one on the left of the leader. Nothing was as yet in visibility, but we are getting warm!

On the second game move, BLACK's cars did another 24 in. move along the North Road, while his tanks trundled on in column, the head of which came up to the nearer of the two ruined cottages. RED's No. 3 tank accelerated, doing its full 15 in. road move and outdistancing the others, who were limited to the 8 in. cross country move. With all these moves completed, the situation was as shown in *figure 2*. First to note enemy activity were the armoured cars, but their radio message to their tanks was unnecessary, as the leading Mark IV had already seen the RED force, and vice versa, (they were just inside the 45 in. visibility). Both sides opened fire, this being a simultaneous operation, naturally, and this is still the second move we are working on, of course.

Let us take RED first, then. The range of the leading armoured car from T.34/No. 3 is just within the 20 in.-30 in. section—so to score a hit requires a throw of 8 or more with two dice. RED throws, gets only 5—no hit. T.34/No. 2 fires at the same target—range this time 30 in.-45 in.—9 is required for a hit, and 10 is thrown! A hit, a palpable hit, no less. The Tank Stick (see its description in Part X) shows the strike angle of 'minus 1', reducing RED's Strike Value from 6 to 5. He throws 9, which with the 5 makes 14, and as the armoured car's Defence Value is only 12, it is therefore well and truly 'kaput' and out of action. First blood to Red!

(NOTE—I have said 'out of action' deliberately, because later on we shall see that this can be a matter of degree, or even time, the time being that occupied by the crew in getting the vehicle back into service, if, of course, this is possible).

Now for BLACK's armoured car; the nearest T.34

REFERENCE TABLE

Vehicle	Speed		Gun	Maximum Range	Strike Value				Defence Value
	Road	X-country			0"-10"	10"-20"	20"-30"	30"-45"	
T.34/85	15"	8"	85 mm.	60"	11	9	8	6	14
Mk. IV	12"	6"	75 mm. (long)	45"	7	6	5	4	14
Armoured Car	24"	6"	50 mm.	30"	5	4	3	—	12





The "Battlefield" from the north, river sections, bridges, walls are by Bellona, trees by Merit.

is just within maximum range of its 50 mm. gun—30 in.—and 8 is required to register a hit, but, in fact, only 5 is thrown—not enough.

Continuing with the firing, we see that the leading Mk. IV is in 30 in.-45 in. range of T.34/No. 3, but RED fails in throwing for a hit, scoring only 4. The Mark IV now replies, and gets a hit with a throw of 10. Its shot is plumb against the front of the enemy tank, and the T.34's Defence Value, with 'frontal' bonus of 1 is, of course, 15. At the range in question, the 'long' 75 mm. has a Strike Value of only 4, and, so requiring a dice throw of 12 for a 'kill', we are not unduly surprised when only 8 is thrown. (Mutterings at this point from General 'BLACK').

So, at the end of Move 2, BLACK has lost an armoured car, RED has not suffered, and on we go with the third game move.

All RED's tanks advanced roughly in line abreast—an 8 in. move—and two of BLACK'S Mark IV's moved off the road to the south, one into the ruins and one to a position near Bridge 'A'. The two others veered off northwards—6 in. cross country move. The surviving armoured car turned back to seek shelter behind some trees, and the end-of-move position is as in figure 3.

Again the firing, beginning with BLACK, whose armoured car had a 'go' at T.34/No. 1, on the right of RED's line, the range being 20 in.-30 in. The throw of 7 was insufficient to score a hit. Three Mark IV's were now able to fire, and the one ensconced in the ruined cottages scored 6 in attempting to hit T.34/No. 4 at 30 in.-45 in. range—no hit. The next, beside Bridge 'A', singled out the RED tank on the road, at the same range. It registered a hit on the front of the enemy, but the throw for effect was not

enough against the Defence Value of 14 plus 1. The third Mark IV also failed to score. All this being pretty frustrating for BLACK.

Now for RED. The two right hand T.34's—Nos. 1 and 2—both fired at the armoured car, at 20 in.-30 in. range, but neither scored a hit—most fortunate for this very vulnerable vehicle. The other T.34's fired at the BLACK tanks southwest of Bridge 'A' and again, much to RED's disgust, neither made the 8 necessary for a hit at the applicable range.

On we go with the fourth move, then.

All RED's tanks eased forward somewhat, and BLACK also advanced. Mark IV/No. 2 moved from the ruins towards the river, No. 1 from the south side of the road, to the north, just west of Bridge 'A', No. 3 due east, and No. 4 back onto North Road. (Figure 5.)

Now the firing: RED's No. 1 tank had a go at the side of BLACK's armoured car and, throwing a 9, scored a hit (20 in.-30 in. range). With no angle deduction, he then threw a tremendous 11, giving, with the Strike Value of 8, a total of 19. No doubt about this—BLACK's second armoured car was no longer fit to take any further interest in the proceedings. The other three RED tanks concentrated their fire on the Mark IV by the bridge, but only one scored a hit, and its subsequent throw for effect was only 4, which was not enough to have any effect on the target's frontal armour. Three Mark IV's replied, all registering hits, but not one of the effect throws was enough, although one was pretty much a 'near miss'.

And still no RED casualties!

On Move Five, RED T.34/No. 1 crossed Bridge 'B' and positioned itself on the north side thereof

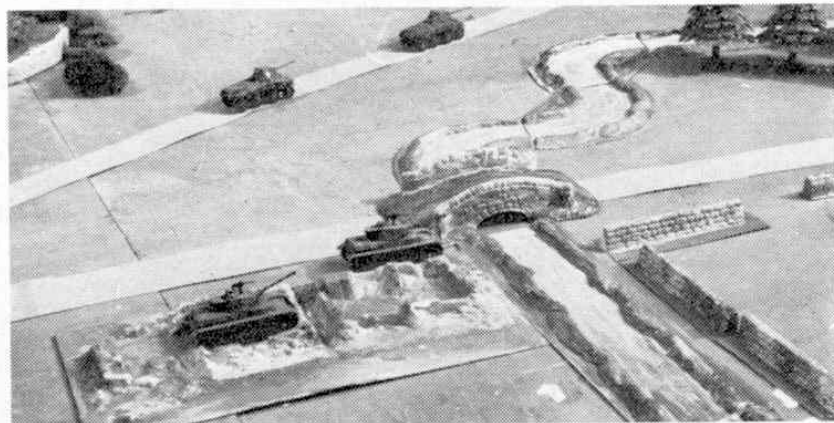

Two "BLACK" tanks take up firing position while the armoured cars race off up the North Road. (All vehicles are Minitanks.)

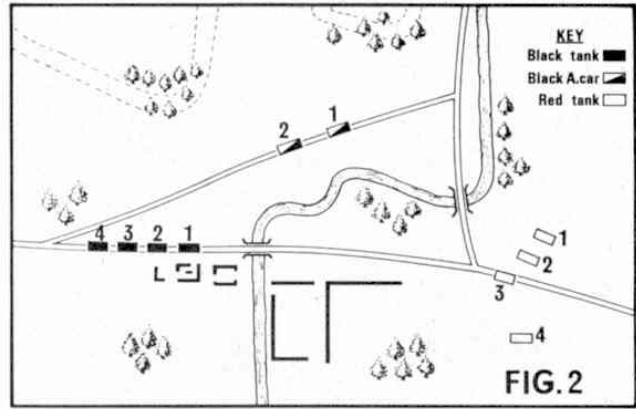
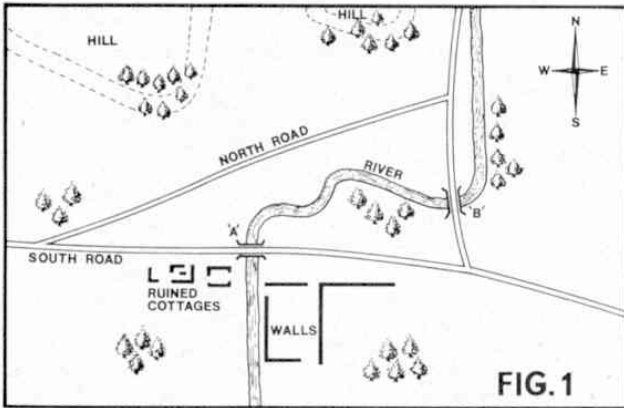

facing west, while No. 2 came up to the south end of the same bridge. Nos. 3 and 4 advanced 8 in. BLACK moved his No. 4 tank eastwards on North Road—a 12 in. move—his idea being to threaten RED's right flank, while his other three remained pretty much in the same positions. (Figure 5.)

The firing, then: with BLACK beginning. Mark IV/No. 4 fired at the T.34 at the north end of Bridge 'B', scored a hit, but the effect throw was pair of '1's'. BLACK's No. 2 then had a crack at T.34/No. 4, and at 10 in.-20 in. range scored a hit, but had the horribly bad luck, on throwing for effect, to get two 1's again. Both No. 1 and No. 3 Mark IV's also scored hits, but failed with their effect throws. Hard luck on BLACK.

Now for RED: Tank No. 1 fired at the Mark IV on the North Road, and scored a hit. Defence Value in this case 14 plus 1 frontal bonus, but the effect throw of 9 was enough with the S.V. of the same to put the target out of action—the Mark IV 'brewed up'. T.34/No. 2 failed to score a hit on its target, but No. 3 at 10 in.-20 in. against No. 3 Mark IV, hit it, and then threw 7 for effect, giving a Strike Value of 16, and yet another BLACK tank went up in smoke. Finally, the last T.34 failed to hit its target, and that's the end of the move.

And one might say, there it is. What's to be done? In the circumstances, having suffered so heavily, BLACK would be wise to pull out, if he can, and fall back towards his main body. Reinforcements could be brought up, of course, and it might be hoped that they would include heavier metal to take on the formidable T.34's. In retrospect, it might have been fairer to have had the 76 mm. gun variant for the T.34 rather than the one equipped with the 85 mm. One can imagine the dismay of the Germans in Russia when for the first time they came up against such a powerful weapon as the T.34. No wonder that the process of bringing out the "Panther" had such priority.

Anyhow, we have had our first "Battle," albeit a quick and simple one, and it must be obvious that it was only a warmup for bigger engagements. There would be no harm in carrying on from where we left off, and if the reader wishes he can organise reinforcements and continue the conflict. If any should do so, I should be glad to hear what happens. Later on I hope to set the occasional Tactical Problem with a given map and forces, together with specific objectives, but of this, more later. Meantime, now that we have begun to familiarise ourselves with land warfare, we shall get back to the "Queen of Battles"—the infantry—and add a few more interesting factors to "Battle".

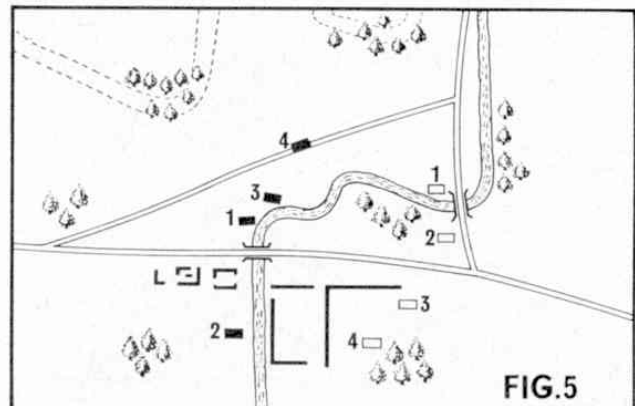
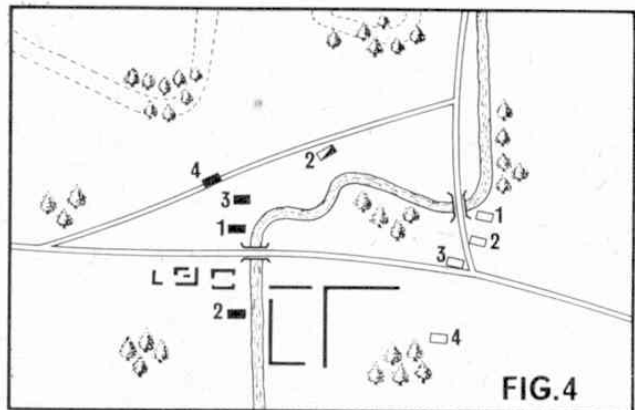
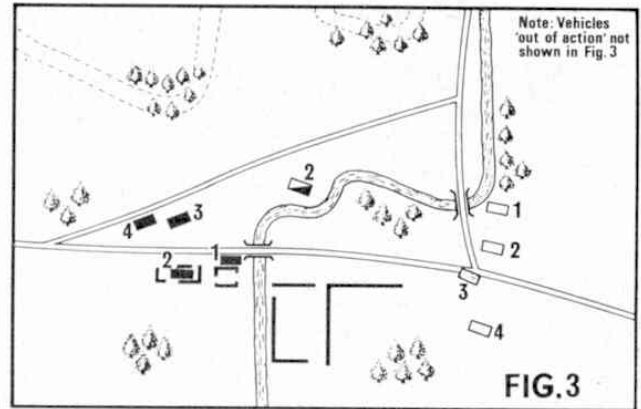

# BATTLE

## Part XII—INFANTRY WEAPONS

by  
**Charles Grant**

AFTER OUR little excursion into the realm of armoured warfare, we return, as I indicated at the end of Part XI of "Battle", to the footslogging infantryman, without whom, in spite of the incredible sophistication of the weapons of even the period we are concerned with, neither battle nor campaign can be successfully waged.

Way back, in Part IV of "Battle" to be exact, we made a preliminary examination of the weapons of the footsoldier and an attempt was made to divorce them from the unreality with which various entertainment media have invested them—the 'bringing down of a rapidly moving target at several hundred yards range with a pistol' sort of thing. We also took the first step to giving effect to these weapons in our game by listing the maximum effective range of those we proposed to use, taking an average for each main type of weapon, while appreciating that the same sort of weapon in different armies had probably slightly different characteristics and capabilities. Once we have devised a system for assessing the amount of damage these weapons can do as an average, the player can work out the finer details of the different types, if he wants his game to have more refinements than is proper to consider in this context—that of getting off the ground with the elements of the game.

Right then, we begin, not unreasonably I think, with what is even today the mainstay of the infantryman, to wit, his rifle. As with any sort of armament, the greater the distance that his target is from the rifleman, the less—obviously—will be the likelihood of that target being hit, and at the maximum range of the rifle, which we established as being 9 in. (or 300 yards in 'the real thing') the average infantryman is only going to have a pretty slim chance of hitting anything other than a "sitting duck". Pace out, if you like, 300 yards, remembering that your pace is at most 30 in., and listen to your own sounds of surprise when you see just how tiny is the human figure at that distance. The closer you are, naturally, the greater the chances of getting a hit, so, as for artillery armour-piercing fire, we shall subdivide rifle range into three—

0 in.-3 in., 3 in.-6 in., and 6 in.-9 in., labelling them close, medium and extreme range respectively.

We shall not give our requirements for a hit at these ranges right away as a second factor has to be discussed. Remember that we are dealing with infantrymen who are lurking about and dodging here and there to confuse the opposition, and doubtless being properly trained, are making the maximum use of ground irregularities, buildings, bushes and so on, all of which can be described as 'cover'. This is quite certainly a vital consideration and one which must have a very appreciable effect on the result of rifle fire or indeed of any other infantry weapon. It is going to be a great deal easier to hit an enemy who is standing up in the open with his whole body in full view than the one who is almost totally concealed in a fox-hole or who is crouching behind a wall. Not only does that fraction which is visible present a very small target but much of his anatomy is pretty well 100 per cent safe behind the wall, or whatever he might be using as cover. On the other hand he might be hidden by bushes, a hedge or a fence, although this, while affording a high degree of concealment which makes him a pretty difficult target, does not provide the protection the wall did. This quite simply is the distinction between the two types of cover we have to allow for in drawing up rules for the effectiveness of rifle fire, and for the other weapons we shall be considering later. 'Hard' cover provides not only concealment but protection, 'soft' cover only the former.

Table One (Effect of rifle fire)	Dice throws causing casualties		
	In the open	Soft cover	Hard cover
Range in inches			
0-3	4, 5, 6	5, 6	6
3-6	5, 6	6	—
6-9	6	—	—

So, for our rules for rifle fire, we must make allowance for the vagaries of the bullet the further it travels, as well as for the effect of both types of cover. In "Battle" we adopt the simplest possible system to assess the effect of infantry firing at infantry. We take each individual soldier firing and throw one dice to determine whether he has hit the enemy infantryman at whom he has fired, the single throw determining both hit and result. This is done, as with an armoured fight, when the 'moving' part of the 'game move' has been completed, the range being taken as it stands at the end of the move. One dice throw is made to represent the amount of fire the rifleman is capable of during this time. No one, after all, is going to waste valuable ammunition by wildly letting off a whole fusillade 'into the blue'—a single, aimed shot is obviously far more likely to produce a satisfactory result. So, in brief, when RED rifleman 'A' fires at BLACK rifleman 'B', whether or not he hits him is determined by comparing the result of the dice throw with the appropriate effect as shown in Table One, this being based on the known probabilities of the results of rifle fire at the various ranges given, and at the same time having regard to the presence or absence of 'hard' or 'soft' cover. Table One gives just this, and the reader will see that effectiveness decreases until the point where, at a range of 6 in.-9 in., it is so extremely unlikely that a man behind any cover would be hit by rifle fire that we can ignore it completely. After all, just think how small the target would be

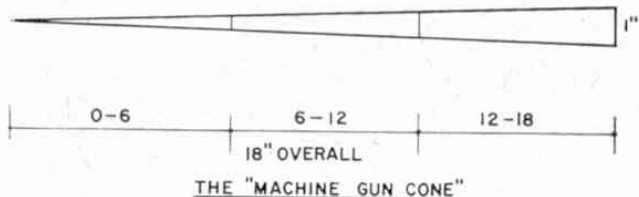



You can always make your own artillery—Self-propelled guns ‘cannibalized’ from various Roco models (David Gates collection).

were the man hiding round the corner of a house, from time to time poking his head out to have a ‘look-see’. Even were he returning fire from behind the same corner precious little of him would be in sight. It would indeed take some fancy—not to say lucky—shooting to register a hit on such a minute and fleeting target.

So, briefly, when ‘A’ fires at ‘B’, a dice is rolled and the range noted. Reference to Table One shows whether the result is a hit. If it is, then ‘B’ is a casualty and is forthwith removed from the table. Incidentally, as firing is considered to be simultaneous, if the now defunct ‘B’ was firing back at ‘A’, player ‘B’ also rolls a dice to see whether *his* man’s rifle shot was successful, and if it is, then ‘A’ is also whipped smartly off the table. (Moving simultaneously is occasionally the cause of wargame anomalies, but there is a simple way of overcoming them, as we shall see later).

From the rifle we progress to the machine gun which, it may be recalled, we decided was to be the heavier type, the tripod-mounted job in contrast to the lighter and more mobile bipod-mounting (say, the wartime Bren, for instance). The range we allocated to this most useful weapon was 18 in. (being the equivalent of 600 yards) and, as for the rifle, we divide this into three—0 in.-6 in., 6 in.-12 in. and 12 in.-18 in., corresponding to close, medium and extreme range. First of all, though, a little bit of Do-it-yourself work is involved, for this is not just a matter of a single round travelling in a straight line. At 600 yards even a short burst from a machine gun will ‘fan out’ somewhat, and when the gunner is ‘traversing’ his weapon, the ‘spread’ will naturally be more.

Table Two (Effect of machine-gun fire)	Dice throws causing casualties		
	Range in inches	In the open	Soft cover
0-6	3, 4, 5, 6	4, 5, 6	5, 6
6-12	4, 5, 6	5, 6	6
12-18	5, 6	6	

This traversing operation—may I point out?—does not involve the tremendous sweep through about 80 or 90 degrees one sees often enough on the screen. This in practice would scatter a hail of bullets half across the horizon and would be a complete waste of ammunition, the idea being to maintain a fairly heavy concentration of fire. However, we do have to cater for the spread and this we can best do with the aid of a simple device, cut from thin card, made from wire bent to shape, or best of all cut from a piece of transparent acetate sheet, this being the ‘Machine Gun Cone’ illustrated in the diagram.

This bit of apparatus is obviously 18 in. in length, and if one considers it as a triangle, is 1 in. across at the base, this giving a ‘spread’ at maximum range of just over the equivalent of 30 yards. This might be a shade more than is desirable for an arc of fire, but it will suffice, as the device would have little use in representing machine gun fire if any narrower. It is divided into the suggested ranges, the lines being drawn

A somewhat risky operation!—a tank commander pops up for a breather. Let’s hope no enemy sniper is about.

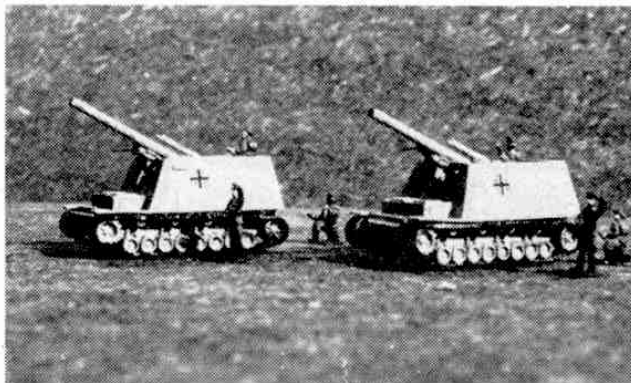

in with a felt-tipped pen or with marking ink, using a fine brush. In operation it is simplicity itself, being placed in position with the apex at the muzzle of the M.G. and laid along the line of aim desired—the advantage of its being transparent becomes apparent—all troops covered by it being considered vulnerable. They have to be diced for as possible casualties. Again we have to allow for both types of cover and in Table Two are given the dice throws required to account for any unfortunate types who happen to be included in the Cone, the effect being more lethal as the range closes. If, by the way, an unlucky infantryman becomes a prey to M.G. fire when casualties are assessed, he nevertheless is allowed to have a crack in reply, if in range of the M.G. He might be just lucky enough to put paid to a member of its crew, which would be a good thing. This is due to the proviso that such firing is simultaneous.

This indeed might be a good time to mention the crew of a machine gun. We assume for the purposes of ‘Battle’ that it requires a minimum of two men to operate, so, when one becomes a casualty, the gun is out of action, of course. However, it seems reasonable to allow an ordinary infantryman to be brought in as a substitute, if available, when the N.G. fires as normal. This we take as being a standard Rule, then, not forgetting that the infantryman must get to the M.G. in his normal 3 in. move and until he does so the gun cannot fire. It might be suggested that not every infantryman is capable of operating the M.G., but let’s be generous and assume that all our men have that little bit of extra training which makes this possible. After all, we can train our troops just as we like, can’t we?

And in our next, we shall round off our consideration of infantry weapons before carrying on with some more action.



# BATTLE

## Part XIII

### More Infantry Weapons

by

Charles Grant

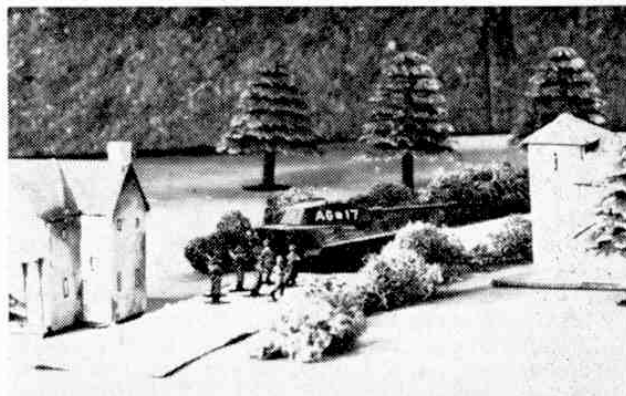

Another combined op.—a 'Tiger' moves into a village with attendant infantry discreetly in the rear.

CONTINUING WITH our discussion of the effectiveness of the infantryman's weapons, we now drop down the scale from the heavy machine gun to its smaller brother, the sub-machine gun, which proved to be so effective for close range fighting. It may be remembered that we decreed the practical range of this weapon to be 4 in. (or the rough equivalent of what we considered to be its maximum effective range of 140 yards) and that we pointed out that it was used in great numbers by the Russian Army in World War II.

Quite simply, we go about assessing its fire power in the same way as we did for the heavy machine gun by constructing a cone of fire. This will be much smaller than the previous one, naturally, but will have, in proportion to its length, a rather wider "spread", partially due to its being hand held, rather than fixed in a rigid mounting, and to the consequently increased "waver". The diagram shows the SMG "cone of fire" and, as we said, it is 4 in. in length and 1 in. wide at the extreme end, or its base, if we think of it as a triangle. This would give an actual spread of over 30 yards at 140 yards range, probably somewhat excessive, but it is better to err a little in this direction rather than to make the device too narrow—its true tactical effect in the latter case would be pretty well lost.

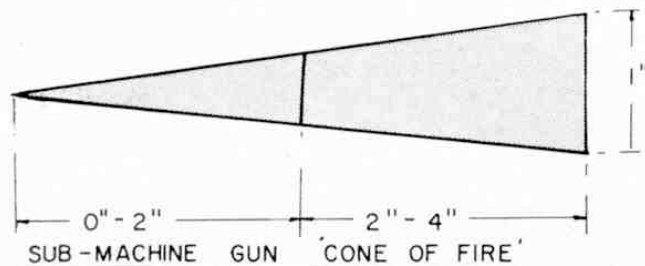

It would be a trifle pendantic as well as impractical to divide it as we did HMG range and rifle range—that is, into three subdivisions—and it will be seen that the SMG "cone" consists of only two sections—you might call them close (or point blank) and distant range respectively. Once again we have to allow for the possible presence of both 'hard' and 'soft' cover and these factors are included in the Table relative to the weapon. In practice, just as for the HMG the "cone" is placed with its apex on the firing SMG and laid in the desired direction of fire. Whatever is within the area of the "cone" has to be thrown for as a possible casualty, and if the dice shows that a hit has been made, the victim is summarily removed from the field of operations.

On to the next weapon, then, this being a highly specialised not to say deadly one, namely the infantry anti-tank weapon, the rocket launcher. This will probably be the 'bazooka' or the 'Panzerfaust' depending on your choice of army. Let us for the time being simply refer to it as the 'bazooka'—the battle-gamer will, I doubt not, make his own choice as to which to use. Now, as will be speedily discovered, if not already known, this is pretty much a one-shot weapon, with the operating crew doing a very 'dicey' and dangerous job. By which I mean that it pays to make the first shot tell, as the opportunity for a second, let alone a third, will not be too great. The range, it will be recalled, is short—a maximum of 6 in.—and for the team to get so close to its quarry, almost always a tank, the latter had to be stalked with great cunning, and if possible approached from the rear, or at least the side, this to ensure that the projectile would hit the less heavily armoured sections of the tank. The risk of being seen more quickly if a frontal attack was considered is obvious. One round from a bazooka, if a hit, was usually extremely effective—its strike value at this close range being high—and the chances of 'brewing up' a tank very favourable. If the first shot missed, it was then a question of the bazooka operators making themselves scarce with the minimum loss of time before the tank's MG's swung round to pour a stream of bullets at the presumptuous attackers, with unhappy results for the latter. The thing then, if it were found impossible to follow up a tank—it would usually be moving more rapidly than men on foot—was to lurk around in a position which the enemy would be likely to pass at close range and, at the appropriate moment, to let fly. Hiding in a house or ruin was just the thing, but the player is earnestly counselled to remember just where he conceals his bazookas if he is laying on an ambush.

In a very recent game I supervised—'umpired' if you like—one player had secreted, unobserved by his opponent, no less than two bazookas in a certain house. Some moves later an enemy tank came up and for two moves occupied a stationary position, almost touching the house in question. Wargamer No. 1, in the heat of the action and with his attention concentrated on another section of the 'front' completely overlooked his bazookas until the enemy tank had moved off 'way out of range. When it did occur to him what an opportunity he had missed, his scream of pain must have rattled the tracks of every tank on the table. He was later seen kicking himself all round the room—he'd lost the game, in fact.

Enough of reminiscence, though, and back to the



business of the bazooka. Maximum range, as we have seen, is 6 in. and again we divide into two—0 in.-3 in., and 3 in.-6 in., and for these the Strike Values are 7 and 6 respectively. You will see that, at close range, it requires only a throw of 8 with two dice to knock out a Russian T.34 or a German Mark IV and one less if the hit is on the rear of these vehicles. Of course, it must not be overlooked that two dice must first be thrown to score a hit, but at 0 in. to 6 in. only a 6 is required. This is not too difficult, but it does make the necessary allowance for the nervy chap—as who wouldn't be?—when a cracking great tank is lumbering past only a couple of dozen yards away.

A point arises here—as it did with the two men operating the heavy machine gun—and its solution will depend upon how the battlegamer organises his army. What happens when one of the bazooka team becomes a casualty, say from rifle or machine gun fire? It is probably true that each member of the team is pretty much of a specialist and could not be replaced by an ordinary infantryman, or not with much success at least. One can consider the bazooka team to be a single unit, enacting the rule that should one fall the whole team is out of action. On the other hand, as with the machine gun crew mentioned in Part XII the player can opt that the casualty may be replaced by an ordinary infantryman, when the latter can get to the spot. This, though, is a personal matter and the wargamer can decide that all his infantrymen can double as bazooka operators.

Again, if I'm allowed, I shall digress just a little, since we are dealing with bazookas. For the simple reason that they were the only troops not claimed by other wargamers of my local group, I took the Airfix 20 mm. Russians for my forces and it was not long before I discovered that, although equipped with mortar and machine gun, they had no rocket launchers. This was a problem which was easily resolved by what is known in model soldier circles as conversion. The present undertaking involved the kneeling Russian rifleman and the one advancing with his rifle held close to his body—a sort of half-crouching position. With a sharp knife—there is a multitude of suitable craft knives which can be used for this sort of thing—the rifle was removed from the first, leaving the arms still in the firing position, and replaced by a length of wire cut to a length representing that of a bazooka.

SUB-MACHINE GUN FIRE	Dice throws to cause casualties			
	Range	In open	Soft cover	Hard cover
	0"-2'	3, 4, 5, 6	4, 5, 6	5, 6
	2"-4"	4, 5, 6	5, 6	6

The rifle is likewise cut away from the second man and replaced by a very short length of wire, of slightly smaller diameter than the first, to represent the projectile. This is the briefest of descriptions of an operation which can be far more elaborate. The 'bazooka' can be furnished with sights and other gadgets, and the rocket filed to a more realistic shape, but all this is optional. In my case, the process was simple but functional, its purpose being basically to provide myself with a force of rocket-launchers. Finally, the two figures—another foible of mine—are carefully cut from their original stands and replaced on new ones cut from thin card, using Evostick as the adhesive. One hears all sorts of tales about how

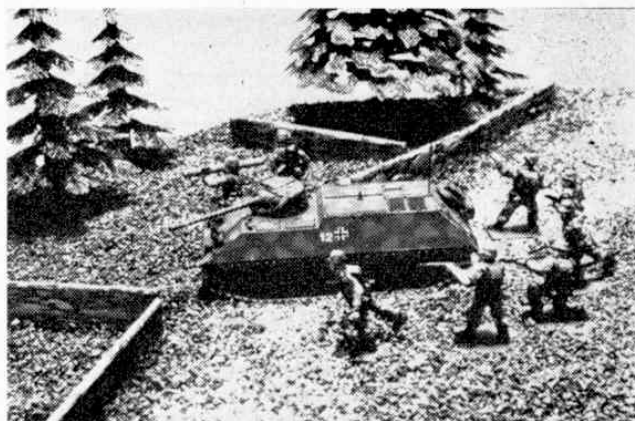

Infantry in attack, with the support of an armoured personnel carrier.

difficult Airfix figures are to glue, but this stuff seems to work splendidly. By the way, all my Airfix troops are on my own stands—they are slightly larger than those provided by the manufacturer and the figures stand more securely on a rough or sloping surface.

We might as well, before finishing with this weapon, deal with the move on the battlegame table of the bazooka crew. As we know, our infantry move is 3 in., and so will be the move of the crew. Query? Can it move the full 3 in. and fire in the same game move? I should say yes! It seems to me to be a fairly quick matter for the two men to get into position, load, aim and fire the weapon. On the other hand, the HMG would take longer to get into firing order—to get the gun set up, ammo. belt ready and so on. So the HMG cannot move and fire in the same game move—if it is moved any distance by its team, the player must await the next game before it can be operated. Fair enough?

On we go then, to deal briefly with two widely differing weapons, their only similarity being in their shortness of range. The first is the pistol/revolver, referred to in the first instalment on infantry weapons, and to which we gave a range of 1 in. To all intents and purposes it is practically a melee weapon, and when two 20 mm. figures are within an inch of each other it does look as though they were close enough to swap punches. The pistol is still useful, though, although not as much as it would appear from what takes place in the main streets of Tombstone or Dodge City or whatever. It is possible, too, to have one of the men behind cover—a wall could just be squeezed into the 1 in. range—so we shall have to allow for this. One dice is thrown, then, if the target is in the open, 5 or 6 puts him 'hors de combat', if he is behind any sort of cover, then a 6 is necessary to make him a casualty.

Finally, there is the man-carried flame thrower, a fearfully effective weapon under the proper conditions. Again, limited by range, we shall initially use it as an ambush weapon against tanks and the like, but it can be used for 'flushing out' bunkers and strong points. As far as vehicles are concerned, once the stream of flame had hit, that was almost invariably enough. At the close range of the weapon, it was difficult to miss—its range of 1 in. being about 33 yards in the 'real thing'. A dice throw then—one dice only—with the target within range—a tank, say—anything except a 1 and it goes up in flames, and no messing.

This leaves only a couple of infantry weapons to consider, both high explosive ones, although at opposite ends of the scale—the hand grenade and the mortar—and concerning them, more anon.

# BATTLE

by

Charles Grant

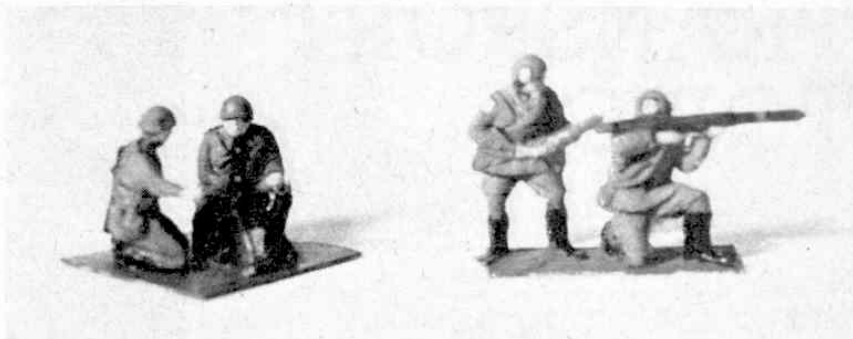

## Part XIV – Infantry Weapons – Conclusion

THE TWO last infantry weapons we have to consider are those which involve the delivery of some sort of explosive projectile—the hand grenade and the infantry mortar. The first is obviously of relatively limited range and of doubtful accuracy but for close range fighting, above all in built-up areas, it has a definite and important role to play. It may be recalled that it was given (in Part IV of “Battle”) a range of 2 in., by our scale an equivalent of 66 yards. This is really a very good throw and no mistake, but we have to err on this side rather than on the other, particularly when we have to consider the distance it will burst from the man who throws it in relation to the radius of the actual burst circle. What I mean is this—is the burst going to be so big as to include the spot whence it was thrown? It would hardly do to have an overlap whereby the man who threw it was caught in the blast of his own grenade! What then is the lethal area? Now, the effective burst area of a hand grenade varies pretty widely according to the nature of the surface it exploded on—this will be greater on a hard than on a soft surface, and, of course, the actual explosive effect will be much greater in a very enclosed area if it, for instance, goes off inside a house, having been lobbed

through a window maybe. Generally speaking—and allowing for the different capabilities and power of grenades of different national forces—if we take the blast area in the open as being a rough circle of 30 to 35 yards diameter, we shall be hitting a fair average. This, on our wargame table scale, will be 1 in. As to its effectiveness, it would appear that troops within this area would have, at best, only a 50/50 chance of emerging unscathed. So if, having upon a sheet of transparent acetate, inscribed a circle of 1 in. diameter, we place this with its centre upon the point where it is desired our grenade shall burst, dice—one per man—will have to be thrown for any personnel unlucky enough to be covered by the circle. If the die comes down 4, 5 or 6, he has had it, and is forthwith removed as a casualty.

In fact, it might be quite handy to construct an easily read grenade device to use in such cases. On the acetate, draw the 1 in. diameter circle to represent the burst area and, with the same centre draw a circle with a 4 in. diameter. This produces what is shown in Diagram One. When your man wants to throw a grenade the device is placed with its centre on the Point of Aim. If the ‘grenadier’ in the outer area—i.e. between the 1 in. and 4 in. circles, he is safe from the blast of his own grenade and can left fly then with impunity. On the other hand—if within the 1 in. ring, he’d better think again, and naturally, if outside the 4 in. one, he is out of range of his desired target. This device is quite obviously not a ‘must’ but it will be found to expedite matters just a little.

The above refers to grenade throwing in the open, but if it happens that the thrower is on one side of a wall, say, lying prone as he well might be, he need fear nothing from the blast if he simply lobs the grenade over the wall at an enemy on the other side—it will act as a protection from the explosion. It has to be a good solid stone wall, needless to say. It is much the same when it is a question of putting a grenade through the window of a house under attack. The thrower stands beside the window—it is ruled that he must be in actual bodily contact with the building—and the grenade goes through the window. No circle is required, the blast being contained within the walls of the house, and, thus confined, it has a greater effect that had it taken place in the open. Any troops therein will have to be diced for, and 3, 4, 5 or 6 will suffice to put any one of them out of action. This seems pretty deadly, I know, but it must not be overlooked that the grenade man must get up to the house, which in itself may be a very hazardous undertaking, if those within are active with rifle and sub-machine-gun.

As to the number of men to be armed with grenades,

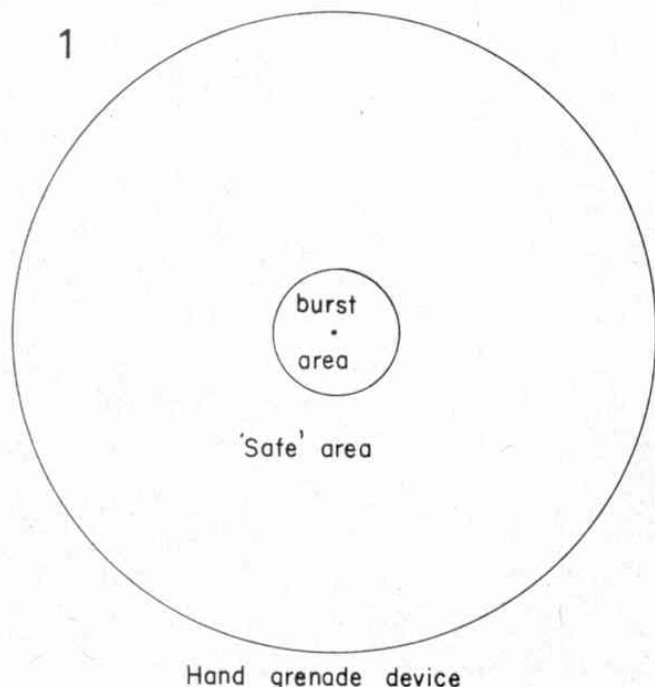

this is largely a matter of personal taste and inclination—I think myself that only a limited proportion should be so equipped. Certainly, if one has figures actually in a grenade throwing attitude, then it would seem logical to use these only, to avoid confusion. Again, all this depends on the wargamer's organisation, and of this rather more later.

So much for the hand grenade, then, and we proceed now to the last infantry weapon we are concerned with at present, and most certainly it is one of the most important. I remember reading—I simply cannot remember where—that the mortar was the most effective anti-personnel weapon to be used in World War II, and it was employed in enormous numbers by both sides and all armies. What we are going to deal with now is the infantry mortar we made reference to in Part IV, and whose maximum range in our game was to be 50 in. (This, I repeat, is the infantry mortar in battalion use, as opposed to the heavy types which are properly to be considered in the category of artillery.) Into our weapon specifications we must bring a new factor, this being minimum range. Obviously, the elevation of one's mortar can be increased to the point where, instead of the range increasing, it actually begins to get less, and this could get to the point where the projectile will fall to earth far too close to the mortar for comfort. This won't do at all, and of course, as the mortar bomb—even of the smaller calibres—has a pretty powerful burst, one must make sure that the explosion does occur at a safe distance from oneself. This minimum range we shall say is 6 in. (or, scaled up—200 yards), and although this might be a trifle overlong, it will suffice for our purpose.

So, with minimum and maximum ranges established as 6 in. and 50 in. respectively, we can carry on. I am aware that the latter may exceed the determined visibility, and the problem might arise as to how the bomb could be dropped on a target that is out of sight. Not to worry, for the moment, but let us simply consider the case of the target in full view of the mortar crew—aided vision, I should say—and on which direct fire can therefore be brought.

Now, although World War II mortars were reasonably accurate, they did not have the highly advanced range-finding devices of their present day counterparts. We have then to allow for possible errors in sighting as well as for the inevitable ballistic vagaries of the propellant charge. By the latter I mean that, if a mortar is fired twice in succession with the same elevation, etc., the two bombs will not fall exactly on the same spot—it would be most unlikely, in fact, if they did. All these factors produce four basic types of error—the overshoot, the undershoot and right and left errors. There can be combinations of two, but for the sake of sanity let us stick to the simple four instanced. We have to think up some way—with a dice throw to give the effect of the imponderable resulting from the various errors—to make the irregularity of the fall of a mortar's bombs resemble as nearly as possible what might be thought of as the 'real thing.' I hope no one will object if I suggest that this can best be done by constructing yet another device. This time you can call it a 'Fall of Shot Indicator'—or more simply—the mortar "whatsit". Diagram Two will show what we have to allow for when a mortar lobs its bomb at a target.

'A' is a direct hit—exactly on the spot aimed at (you can't see what it is because of the burst!), 'B' is the overshoot, 'D' the undershoot, and 'C' and 'E' right and left hand errors respectively. Back now to that other piece of perspex or acetate you have been saving for just this contingency, and upon it with your

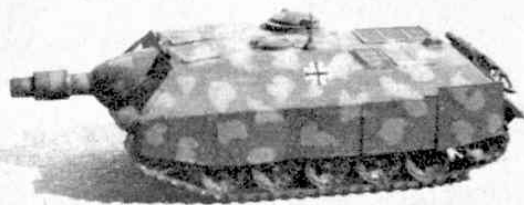

Our heading photograph shows Conversions of Airfix Russians—the 120 mm. mortar 'cut down' to infantry mortar size, and two riflemen converted into a rocket-launcher crew. Above: A heavy assault gun converted from a modern German tank destroyer. (A Roco model.)

pair of compasses you prepare to inscribe five circles in the manner you can see in Diagram Three, together with an arrow to indicate the line of fire, but before you are in business, there is an immediate snag—what about the diameter of the circles? In effect, what is the burst area of the mortar bomb?

This, as might have been anticipated, varied slightly with different types of mortar, and it may be remembered that, when first treating of this weapon, we instanced three types—the U.S. 60 mm., the German 81 mm., and the British 3 in. As our knowledge and expertise increase, we may—depending on our taste in armies—juggle about with different burst circles for different weapons, but right now it will be very much easier to establish a kind of 'mean.' If we lay it down, then, that the lethal area of the average mortar bomb burst—within which one might say that things were pretty fraught—is a circle of about 60 yards diameter, this should be just about right. Quickly converting this distance to our table scale we arrive, at a circle with a diameter of 2 in. (to the nearest inch). This then will be the size of the burst circles in our device or "whatsit", and you will see that a slight overlap is allowed. We don't want the errors to be unrealistically large.

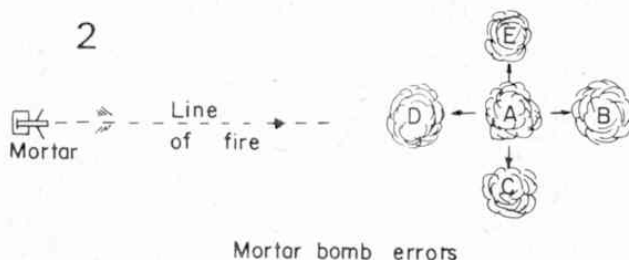

Mortar bomb errors

As to use, it is simple—the player whose mortar is firing specifies his target, and throws one die. This is the 'ranging' shot, from which adjustments are made for correction, sometimes called 'bracketing'—a deliberate overshoot followed by a deliberate undershoot, and by taking an average, hoping to get a direct hit with the next. It is ruled that this has to be done with each new target, and if 5 or 6 are thrown, the target is ranged and the device placed upon it, the arrow in line with the direction of fire. The die is thrown once more. If 5 or 6 come up, it has been a direct hit, and whatever is in the area is a possible casualty. As for the grenade, a 4, 5 or 6 on the next throw 'for effect' is sufficient for the victim to be

*continued on page 311*



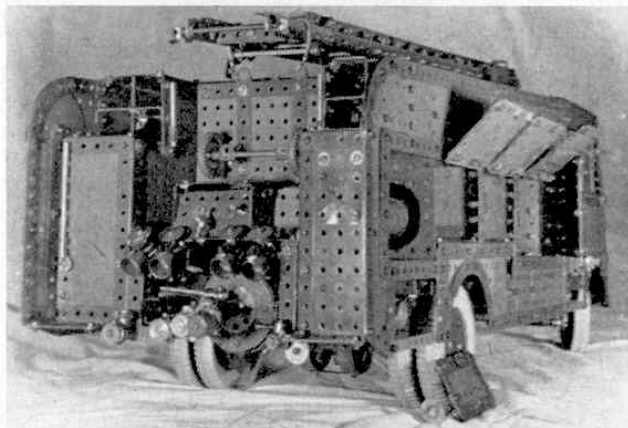

Top: This picture shows S. J. Kennedy of Christchurch, New Zealand with a half-life size model of a Violinist which netted him third prize in Section B. Although the model does not actually "play", it saws away with its bow, moves its fingers, winks and taps its foot!

Above: First Prize in Section B went to G. R. Illingworth of Birmingham for this superb model of an Auxiliary Fire Service Self-propelled Fire Pump based on a Bedford 7-ton chassis. The detailed features shown in this view are only a few of the many incorporated in the model.

**PRIZE-WINNERS**

**SECTION A:** 1st. P. Miller, P. Quebec, Canada; 2nd. M. McCrorie, Hailsham, Sussex; 3rd. P.

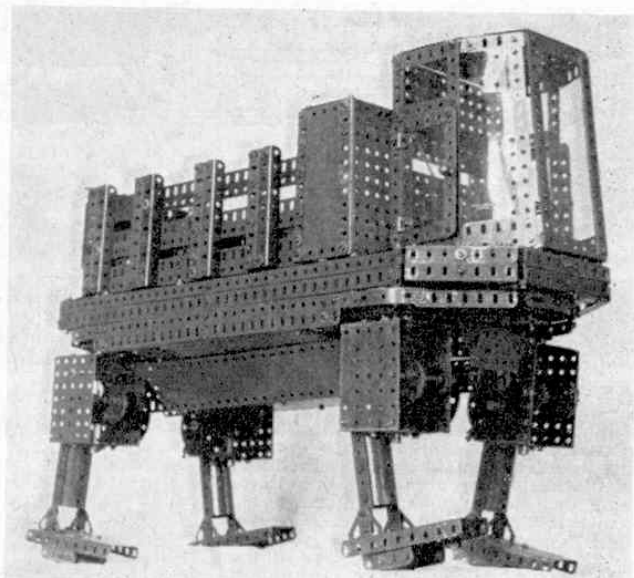

Originality of subject was one of the many things taken into account by the judges of the Model-building contest. This model of a U.S. Army Walking Truck was original enough to help H. W. Henry of Strood, Kent, towards a £1.1.0d. prize in Section B.

**Spiers, Walsall, Staffs.**

Consolation prizes: R. Thorne, Wells, Somerset; I. Miller, Canada; P. Berry, Bury St. Edmunds, Suffolk; P. Spencer, Romford, Essex; A. Grimshaw, Kettering, Northants; G. Leech, Auckland, New Zealand; M. C. S. Cannell, London N.W.7; R. Rahman, New Delhi-11, India; J. Turton, Romsey, Hants; P. Jones, East Grinstead, Sussex. **SECTION B:** 1st. G. R. Illingworth, Birmingham 26; 2nd. C. A. Burnett, Victoria, Australia; 3rd. S. J. Kennedy, Christchurch, New Zealand.

Consolation prizes: J. C. Palmer, Droitwich, Worcs; A. Farina, Milan, Italy; H. Groen, Holland; S. Jones, Chester; I. Potts, Hartlepool, Co. Durham; L. S. Gelernter, London W.14; E. Amirault, Sask., Canada; J. van Dyk, Apeldoorn, Nederland; H. W. Henry, Rochester, Kent; B. R. Kuss, Queensland, Australia.

**BATTLE continued from page 299**

removed and returned to the box or shelf whence he came.

If 1, 2, 3, 4 or 5 are thrown when determining where the mortar bomb landed, although this may be a miss in terms of the intended target, there still might be something to throw for—transport or support troops, and with personnel, 4, 5 or 6 ensure a casualty.

If the 'ranging' shot is unsuccessful—i.e. if a 5 or a 6 is not thrown, this has to be repeated on the next game move or until in fact the range has been established.

Once again, I say that this process refers to firing at targets in direct sight of the mortar crew. Firing under radio control is to come, and one final point has to be thought of—the composition of the mortar crew. Two men should be enough, and again the player can decide whether, if one is knocked out, his place can be taken by an ordinary infantryman. The move of the mortar and crew is as for the heavy machine gun and its attendants—it *cannot* be shifted and fired in the same move. Even an infantry mortar required a fair bit of lugging around and setting up for action.

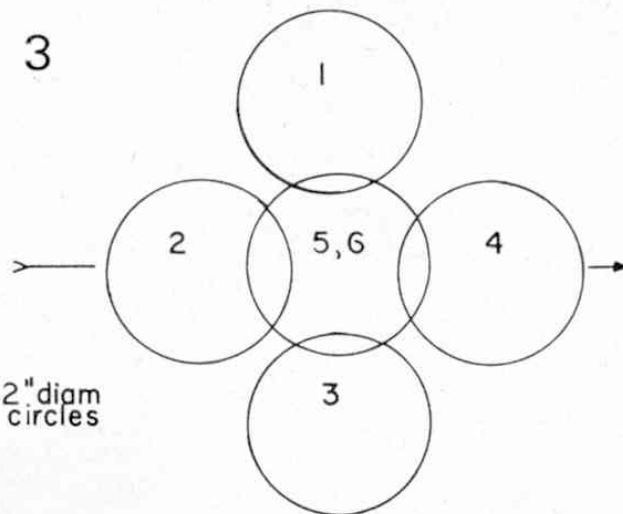

Mortar 'Fall-of-shot' indicator



# BATTLE

by Charles Grant

## PART XV

## INFANTRY

## ORGANISATION

**B**EFORE THROWING our infantry into the heat of action it might be a good thing to devote a little time to a consideration of just how they should be organised to carry out their proper role on active service. This is a question, obviously, in which the wargamer can make his own decisions, although, if he should be really historically as well as militarily minded, and has opted for an army of some particular nation or other, then it would be logical for his wargame troops to adhere to the system prevailing in his adopted country's forces. If, for instance, he has chosen to field an American army—and more especially, a force of U.S. Marines (the Airfix box is a considerable temptation to do so)—then he will have to do some reading up about the organisation of that very famous outfit. On the other hand, if his army is a totally or even partially fictitious one, he must still know a little about the basic essentials of military organisation to ensure the maximum effectiveness of his troops. Naturally, this is not to say that the wargamer cannot do what he likes with this army, and if he thinks it a good thing—just to hazard one possibility—to have his infantry units armed with sub-machine-guns only, then that's entirely up to him, although when he does commit such a force to battle he is liable to receive a sudden and grievous shock if he comes up against infantry with the proper quota of weapons and with, among other things, a due proportion of riflemen. It will very quickly cause a big rethink and a quick dash to the nearest and most convenient book dealing with the various weapons used by the infantry arm.

I don't intend to fatigue the reader with a long list of books on the subject, or to enumerate a lot of highly technical treatises, believing that, as I have said before, it is much better to give one readable and generally accurate source. From this, if desired, the enthusiast can go on to, if not necessarily better, at least more detailed references or can remain content with the one given, as he pleases. As far as present needs are concerned, I cannot do better than suggest a most informative book by an American authority—Jac (this is the correct spelling) Weller, this being "Weapons and Tactics", and it is from this work that the following details are culled—adding the remark that the volume is excellent reading and worth any amount of perusal.

In view of the fact that the next part of "Battle" will be the account of an actual infantry action on the wargame table, what we are going to do now is to assemble sufficient data on the organisation of the units

appropriate for such an action—it will be a small scale one—and to see how we can reproduce them in miniature within the limitations of the model soldiers we use. What we may well end up with might be a pretty polyglot sort of thing—wargamers being notoriously of an individualistic and experimental turn of mind—and indeed it might not be a bad thing to take the best of all possible systems and decide upon a setup which we think would give a good account of itself, even though it might not be strictly in keeping with any particular national army. As long as it has some sort of military validity and is not too far out of this world, we need not be over-concerned.

If would be best, then, if we started on the ground floor as it were, for after all it is on the smallest scale that we shall be operating at the outset, and what better to begin with than the basic British infantry unit (not forgetting that throughout we refer to the last year or two of World War II—present day organisation might well be different, not only as regards Britain but also with other countries with which we might be concerned). This is, in fact, the rifle section, three of which, plus a headquarters section, made up a platoon, there being three platoons to the company, which also had its company headquarters. The principal arm of this section—ten men in all—was naturally the rifle, this being carried by eight men, while the section leader had a sub-machine-gun and there was also the light machine gun, the Bren. While the platoon HQ was equipped with a 2 in. mortar, the company HQ was provided with heavier stuff, three of the short range but very effective rocket launchers, the PIAT. All this made up, if my arithmetic is correct, a fighting company of 125 men, armed with 9 LMG's, 9 SMG's, 3 mortars and 3 rocket launchers, plus rifles. So far so good—this gives an idea of what the proportions of the various infantry weapons should be, the basic rifle sections having stronger support at either platoon or company level.

Let us press on and take a look at a couple of other armies: first the German—again World War II, of course. In it we come across certain similarities to that described above, and again we have a basic unit consisting of riflemen plus a light machine gun. The guiding principle, apparently, was that this squad—ten men in number—could be multiplied 'x' times to provide larger units. Three rifle squads had a support squad, armed with 50 mm. mortars, the four together being reckoned as a platoon. The German company

numbered three of these plus supporting heavy weapons, all very similar, in fact, to the British system. Company headquarters had an anti-tank squad, armed with the formidable Panzerfaust, the German recoilless rifle.

Finally, let us very briefly examine the Russian system prevailing at our particular period. At ground level, we have much the same sort of idea as those already described—military thinking has no great national barriers—the rifle company consisting of four platoons, one of which was the 'weapons' one. This gave a theoretical total of 143 men to the company, their weapons including 2 medium machine guns, eighteen light machine guns, and two infantry mortars. The remaining weapons were rifles and sub-machine-guns, the latter being more numerous than in other armies, in which they were usually officers' or N.C.O.'s weapons.

What we shall initially require is a smallish unit we can use in a simple sort of engagement to illustrate the rules governing infantry in action, and several items normally deemed necessary will be left out for the sake of simplicity. The lack of any sort of signals organisation will be noticed at once, and although the outfit we are considering might not have the benefit of such a luxury, if we are going to consider our units to be representative of something larger, they certainly would be provided with an adequate communications system. Our lot will, however, for present purposes be the immediate combat personnel and as such will provide only the veriest essentials of manpower, although I might point out at this stage that the actual 'company strength used is but a skeleton and will certainly be increased numerically—let alone in ancillary services—as we proceed to more elaborate warfare. With the exception of our fighting troops, we don't want to be cluttered up with too many bodies on the occasion of our first infantry encounter.

The organisation I propose to use, therefore, has basic similarities to those I briefly discussed already, but is strictly an individual one, for which I do not claim perfection by any means. It is most positively, though, very functional and has proved to be so on many a wargame table, operating realistically, in both victory or, regrettably, in utter defeat. The setup is based on three infantry squads, numerically equal although not entirely so on weapon capability. Instead of concentrating the support weapons, they have been distributed, and a glance at the photograph will show the details. Two—Nos. 1 and 2—consist of leader (officer or N.C.O.), 4 riflemen, 2 sub-machine-gunners, and a rocket-launcher team of two men. No. 3 squad substitutes an infantry mortar for the rocket-launcher. The keen-eyed reader might notice that the troops are

vaguely Russian in appearance. This is not surprising, as they emanate from the Airfix box of Russian infantry—the conversions being those already described in this series. Heavy machine guns are also absent. As we shall see later, I use these concentrated in a single group, feeling that they are basically defensive weapons, and the squads we are dealing with at the moment are, I hope, essentially assault troops. The three squads form a company, although for myself I term them a "Battle Group", and if you had three such groups, plus the appropriate support, they might be equated to an actual battalion, as it will be found that in the wargame their capabilities are comparable to this larger unit.

The 'Group' transport is shown in the photograph and consists of three armoured half-tracks—quite happily and without compunction, I mingle Soviet troops and German vehicles, and later on I shall doubtless commit even more dreadful sins—one squad per vehicle. It is assumed that the driver, who is invisible anyway, is an integral part of his vehicle. One can go to town on the numbering and identification of the transport—plenty of 'serial numbers', divisional and other signs and so on all go towards making the vehicles realistic, and, as long as there is for wargame purposes and the writing of orders one identifying number, then it does not matter too much about the rest—artistic licence is tolerated, even welcomed.

One point might be mentioned concerning the actual loading and carrying of the troops. They—the men, that is—can be piled up in the back of their half-tracks and trundled about in an undignified sort of heap, which is all very well, but does not please the eye overmuch—the figures tend to get knocked about as well. It is better to have a series of small boxes—off the table and each numbered to relate it to a particular truck or whatever—into which the troops can be placed, and at the same time something put into the vehicle to show that it is full of personnel—a counter, a tiny block of wood, or even a scrap of paper. This is even more necessary when the transport, as will frequently happen, is covered trucks, into which figures simply cannot be pushed. The actual process of loading or unloading occupies one game move, the climbing in or scrambling out part thereof taking up a third of the move time. This means that, when the vehicle arrives at a particular point during one move, on the succeeding one the troops can be 'debussed' by being placed up to 2 in. from the side of the truck, and when boarding they can be moved 'into' it—or into the representative box—when within 2 in. of any part of it.

After which new rule we are ready for action once again.

Heading photograph shows Anti-tank gun in action with 'prime-mover' in close attendance.

Right: Suggested infantry organisation referred to in the text.

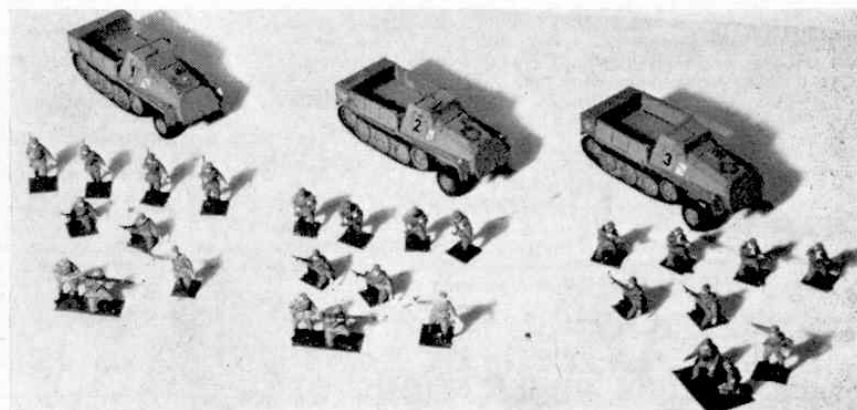



# BATTLE

## Part XVI

### Action at Twin Farms

by Charles Grant

FOR THE demonstration of our basic infantry rules, a fairly simple scheme was devised, this involving a body of infantry in a prepared position awaiting the approach of an enemy reconnaissance group.

Dealing first with the defence of the position—of which the details may be gathered from the plans and photograph—it was entrusted to BLACK, whose troops, in appearance were somewhat Germanic, numbered an officer, nine riflemen, one Panzerfaust and two heavy machine guns, with appropriate two man crews, of course. His task was to defend the two farm buildings, which were fortunate enough to have some excellent cover in the shape of substantial stone walls as well as wooded areas. The whole complex was known as "Twin Farms"—not terribly original, but it will suffice. All in all it was a very fair position and the defence took every opportunity to exploit it, infantry and machine guns being disposed as shown in Map One, while the Panzerfaust team—greatly daring—was hidden behind the East Wall—as it was known—well in advance of BLACK's main defence line. An excellent spot for an ambush, thought BLACK (and he was right!).

The RED attacking force—we're nothing if not original—consisted initially of one group of half-tracked infantry such as was declared in Part XV, and totalled an officer, 2 N.C.O.'s, 12 riflemen, 6 sub-machine gunners, 2 bazookas and a mortar, plus crews. They were to enter the wargame table, which, for the purpose of this exercise measured 5 ft. by 3½ ft., from the east, and, being at the outset 'off' the table, knew nothing of BLACK's disposition. Visibility was determined in the approved fashion by throwing two dice, this giving a pretty average result—20 in. unaided and 30 in. aided.

And so RED made his first move, his three half-tracks, Nos. 1, 2 and 3—spaced at 2 in. intervals—coming along the road from the eastern edge of the table their full 15 in. road move, this bringing the leading vehicle right up to the stone wall behind which lurked BLACK's Panzerfaust men. In accordance with the rules governing defending troops who have elected to remain in hiding, their position had previously been written down by BLACK, and RED was consequently ignorant of their whereabouts until their position had been declared and they had been placed on the table. It was, nevertheless, rather rash of him to come hammering straight up the road without having a thought to a possible ambush. When RED's



half-tracks had come up, BLACK, having in effect, nothing to move, simply declared the position of his Panzerfaust, putting it in the requisite spot. As it was within 6 in. of the leading half-track, he let fly at it without hesitation. The throw for a hit (6 at this range) was easily obtained and the effect throw—also with two dice—followed rapidly. This totalled 7, which with the Panzerfaust Strike Value at this range, 3 in. to 6 in., of 6, made 13, effectively destroying the half-track, its Defence Value being but 11. Nor was this all, for, when a troop carrying vehicle is 'brewed up' in this fashion, all the men therein have to be thrown for as possible casualties—1, 2 and 3 and they are O.K., 4, 5 and 6 and they have to be removed as 'dead'. In the present case, when this was done, RED had lost an officer, three riflemen and a bazooka team, leaving only a single rifleman and two sub-machine-gunners as survivors from the personnel carried in the half-track. The latter is placed on its side, to indicate its destruction, and the surviving troops put down within 2 in. of it, on the side away from the source of the trouble. A splendid beginning for BLACK, and no mistake.

Immediately—that is, on Move 2—RED took prompt action, his No. 2 truck veering off the road to the north, moving 9 in. across country, while No. 3 moved up the road for 5 in. and to its left 6 in. towards the wall sheltering the Panzerfaust, the idea apparently being to outflank the latter on both sides. (You can see how the combined road/overland move is worked out—1/3 on the road—5 in., leaving two thirds at cross country speed, or 6 in.). As it happened, RED reckoned without his host, whose Panzerfaust switched targets and, drawing a bead on No. 3 half-track, scored a hit, and followed this with an effect throw of 14, three in excess of the appropriate Defence Value. Thus No. 3 half-track was well and truly destroyed. This was pretty terrific, and General BLACK's jubilation can be imagined. The crew of this half-track was more fortunate than that of the first, only 2 riflemen and one sub-machine gunner being lost, leaving an NCO, 2 riflemen, one sub-machine-gunner, and the mortar and crew to be stationed beside their shattered conveyance. Meantime, the riflemen and one of the tommy gunners who had escaped from the first vehicle made a forward move (3 in.), firing at the Panzerfaust team, but they were unsuccessful, both throwing 5, a 6 being required, as the target, behind the wall, had the benefit of hard cover (touch and go, though!).

On Move 3, half-track No. 3, the only one still serviceable, moved 9 in. towards North Copse, and all the RED infantry, including the mortar team, moved 3 in. towards the ambush point. The BLACK

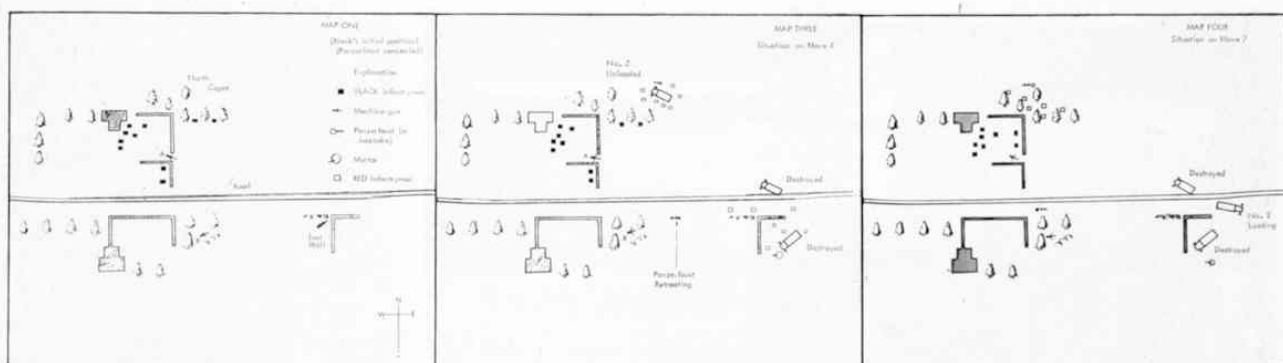

Panzerfaust, however, decided to call it a day and moved back along the hedge (3 in.). Here it was very lucky again, a rifleman and a tommy-gunner failing to register a hit, while indeed this forward move on RED's part brought a sub-machine gunner and the mortar team—south of East Wall—into range of BLACK machine gun 'B', which opened up at once, putting paid to the sub-machine gunner, but failing to hit the mortar crew. (Both SMG and mortar were just inside the MG cone of fire—distant section). By this time, of course, both sides were well within view of each other, and RED had a good idea of the strength of his enemy's position.

After its escape, RED mortar—move 4 now—lost no time in moving back 3 in. out of MG range, and the BLACK Panzerfaust also continued to retreat. It was in the open now but its luck still held out, the leading RED rifleman, on this move reaching the end of the hedge, threw a miserable 1, and one of his comrades, arriving at the East Wall, getting a 4, not enough at extreme range (6 in. to 9 in.). This rifleman himself was safe from BLACK's MG, being behind the hard cover provided by the wall. On RED right, the half-track (No. 2) unloaded, and the two BLACK riflemen in the wood had retired 3 in. towards the safety of their own lines, behind the wall of North Farm, where the bulk of BLACK's infantry was stationed.

Move 5 then: the Panzerfaust crew continued their retreat, missed again by the RED riflemen at the East Wall. (They really were prodigiously lucky.) One of the riflemen from No. 2 half-track was bold enough to emerge a little from the trees and also had an unsuccessful crack at them. In doing so he unfortunately revealed himself to BLACK MG 'A', which fired and promptly cut him down (the MG threw a 6). Deciding he would utilise his one and only half-track to bring up his men from the East Wall, RED started it in that direction (9 in. move across country, again). In the copse the BLACK riflemen made another 3 in. move backwards, while RED infantry continued their advance through the Copse.

Next move—number 6—the Panzerfaust men, greatly to their relief (and the promise of at least an Iron Cross 4th Class) reached their own lines, while their two rifleman friends in North Copse still retreated, pressed by the RED infantry. At the East Wall RED troops began to close up on their half-track which, on this move, had reached the west side of the Wall. RED mortar now opened up on BLACK machine gun 'B', but its ranging shot—a 3—was no good, a 5 or a 6 being required.

Firing again on Move 7, during which the RED

riflemen about East Wall began to board the half-track, or at least those who were within 2 in. thereof, RED mortar failed again with its ranging shot on BLACK MG 'B' (a wretched 1 was thrown, in fact). There was no other firing, and this point we might call the end of the first phase of the operation. RED infantry have suffered a set-back, of that there is no doubt, although they are well established in North Copse, consolidating a jumping-off point for an attack on North Farm. The others will quickly be inside their half-track, ready to move forward, yet even so it is evident that RED has really not a strong enough force to carry on with his attack, but still, after all, his mission was really one of reconnaissance only. Reinforcements must then be summoned, and the question is, just of what would they be likely to consist—another Battle Group of infantry, an assault gun or two, or what? RED could ask for artillery fire to be brought down on BLACK's position as well.

This is the problem, then, to resolve which RED has to make a quick decision. Meantime, we have gone a little way towards a practical illustration of how an infantry encounter is staged, and if any reader would like to carry on with a sequel, I should be glad to hear of it and of the reinforcements used. Indeed it might well be that at a future date the action will be continued, when we have established additional rules to enable us to cope with the situation with more sophisticated forces.

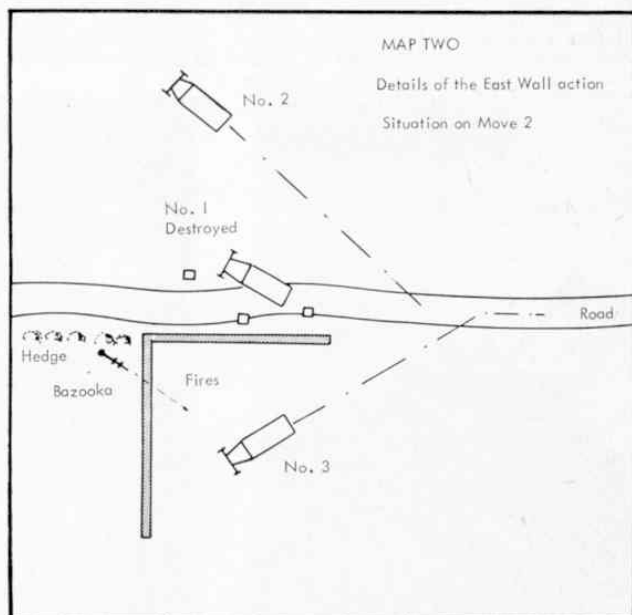

Heading photo shows Black's Panzerfaust making all speed to get back to safety. The maps above and right show progress of the war game.

# BATTLE

by Charles Grant



## PART XVII COMMUNICATIONS

AT THE conclusion of the first phase of the "Action at Twin Farms" (Part XVI), the commander of the RED reconnaissance group was in something of a quandry. It was obvious to him that he needed some sort of support to flush BLACK out of his defensive position, and we left him in the process of making up his mind on the question of what sort of assistance he should summon. What actively concerns us at the moment is not the composition of the follow-up force but rather the means he adopted to ensure its arrival, and this is really very obvious—he called up his base by radio and uttered his cry for help. We can ignore the dramatic dash of the motor cycle dispatch rider—a trifle out of date now.

Now this may not be quite such a simple job as switching on one's transistor, for we are speaking of radio communication under active service conditions, with transmitters and receivers being carried about in vehicles over all sorts of terrain, allowing these delicate pieces of apparatus to be bumped around in a manner calculated to do them no good at all. Generally speaking, the treatment they receive in this way as well as at the hands of an operator frequently working under extreme pressure in desperately anxious circumstances is enough to write-off even the toughest radio equipment. Anyone with wartime experience of the uncertainties of W/T communication can appreciate what a chancy thing it was to get a message through to the proper recipient and how the whole process of radio transmission and reception was a most hazardous, not to say frustrating, process.

What we have to do first is to establish rules to cover whether or not, or how soon, communication by W/T or R/T can be achieved, and also to make allowance for the possibility that the link can be severed at any time for any one of several reasons, atmospheric, technical failure and so on. As a sort of follow-up we shall decide on the composition of a signals section for the infantry organisation we have begun to build up, the start of which was the half-tracked group described in Part XV.

So, briefly to go through the chain of events, the C.O. of RED reconnaissance group instructs his operator—if the latter has not already done so—to make contact with base or command headquarters, or

whatever the next highest link in the chain of command might be. This is probably the most difficult part of the operation—the 'getting through'—and once this has been done, it is much less difficult to keep up the contact. So, with the operator in position—headphones and 'mike' at the ready—we have to take an average of the possibilities and estimate what are his chances of getting through immediately. These are not really tremendous for, apart from technical difficulties, the chap 'at the other end' might be engaged with a third party, and we must allow for an initial delay which might be anything up to several minutes. We make our decision by means of a dice throw—one only being used this time—to determine whether instant contact has been made or not. It seems reasonable to say that the chances of this are about two to one against, so if, when we throw the single dice, it produces a 5 or a 6, well and good, the operator is 'through' and he can get on with relaying the message, asking for orders, seeking assistance, or making a report. This operation must be carried out only once per game move and, naturally, if the 5 or 6 be not obtained, communication has not been established, and we have to wait for the next move for a similar dice throw to be made, and so on, on every move, until the 5 or 6 has been thrown. Once the radio link has been established, it has to be maintained, and on each subsequent move, a dice throw is required to show that the W/T operator is still in touch. Nothing like the high throw required to open communication is necessary, anything but a 1 sufficing to show that contact is still loud and clear. If 1 does come up, however, then the process of obtaining the link has to be gone through again, that is, the 5 or 6 throw has to be made, once per move, until it is obtained.

All the above refers to the normal sort of communication between units—either headquarter or subordinate—but the rules also govern, as we shall see later, the more specialised role of the Artillery Forward Observation Officer, who is directing the fire of his guns by giving, over the radio, references to guide the aim of his gunners who are out of sight of the target and may indeed be miles away. Of this, more later.

Let us go on, then, to examine the composition of



the radio section of the Reconnaissance Group. It could of course be included in the personnel of one of the half-tracks, but it is better to provide it with its own transport, giving it more independence of action as well as more room for the equipment than would be possible in the pretty crowded half-track, cluttered up in any case with men and their weapons. We shall require a fairly small and fast type of vehicle for the job, and what better in fact than the ubiquitous jeep—ubiquitous as far as the Allied armies were concerned, and if one has a German type army, well, then, it could be a captured one. In fact, although we are thinking in terms of World War II, I don't believe that there would be any great objection to our using a more modern type of vehicle—there are many such available in our scale—but the jeep would be more than adequate for the purpose. To signify its special function, we could, by using a spot of Evostick or other suitable glue, attach to its rear a length of thin wire to represent an aerial—and its use becomes at once apparent.

As to the crew, we first have the driver, letting him be an integral part of the vehicle—from the casualty point of view—as we did in the case of the half-tracks. Their drivers were totally enclosed and invisible, but no matter, if the jeep is destroyed, we assume the driver automatically becomes a casualty. Then there is the W/T operator himself, and we can, if we like, use a little conversion to produce this essential member of the team. We did show that the jeep was equipped with W/T by affixing an aerial, but it makes the individual function more obvious if he too has some kind of indication of his job. If the wargamer, however, thinks the jeep aerial sufficient, he need not spend too much time on the operator, and can use—just as an example, and if his army is built up on the Airfix Russians—the kneeling tommy gunner. Simply cut away—with some care—the SMG, and you have a figure which can be used as a gunner as well as the radioman we want him for at present. If you wish, he can be treated as shown in the photograph, by having a tiny block of balsa stuck to his base and by sticking to the little block a length of wire for the aerial. There you have the W/T man in action. This might indeed influence the wargamer to give the operator a sort of second chance if his vehicle—naturally plus equipment—is destroyed, and he survives himself. The set with the figure could be deemed portable equipment with which, despite the loss of his main gear he could possibly maintain contact. It's just an idea though, and entirely up to the individual wargamer.

To allow for the fact that the operator is pretty busy sending and receiving messages, there would be a third man to complete the crew. He would possibly be an officer or an N.C.O. The latter will suffice for us. As 'Signals' N.C.O. he would be occupied with the staff work of his section, and, as an experienced soldier, would be able to keep a 'look-see' at what was going on around him and to use his authority according to circumstances, particularly if the jeep, as might often be the case, was sent ahead of the main group on a scouting or roving commission.

So, to the establishment of the infantry group described in Part XV we add the jeep and its crew of three—driver, the signals N.C.O., and the W/T operator.

Taking the last named as a starting point, it follows that we devote a few words to the next link in the chain. When seeking orders, the group commander would naturally do so from his immediate superior, this being, in our case, the officer commanding the groups making up the next formation—let us call it a battalion and stipulate that it comprises three such infantry groups as we have described. In fact, having regard to its transport, we have every right to describe it as a Motorised Infantry Battalion. It is to the Battalion Headquarters that the W/T operator would normally make his call (we'll take up the question of the overall composition of the Headquarters Group later. At this level, R/T organisation is going to be considerably more complex than it was with the Group setup, there being doubtless several radio channels, both to the component units of the battalion and to any higher command there might be. A rather larger and more elaborate installation would be required and its transport must be something larger than a jeep. If you like, it could be anything up to the size of a 2½-ton truck—it depends on what one wants to acquire if a suitable spare vehicle is not to hand. It's better still, of course, to use a vehicle specially designed for the purpose and I think that one could use, without too much criticism for being 'out of period', the Dodge radio truck in the Minitanks range.

It must be assumed that rather a larger technical crew would be required for the battalion signals vehicle, and we must consider two W/T operators to be essential. In the case of the headquarters section it might not be deemed necessary to show the purpose of the figures as we did with the radioman in the infantry group and any two figures suitably positioned will be adequate—the very useful kneeling sub-machine gunner in the case of Russian type forces is as good as any—with, of course, the SMG carefully pruned away as was done for the other. One of the two could be graded as an NCO, this doing away with the necessity for having an 'additional figure to represent the 'command' element. There will be more than enough of this in the headquarters personnel anyway.

While on the subject of the Headquarters, we might as well finish by devoting a little time to the battalion commander and his transport—it will save time later. The command car can really be anything the officer in question cares to use and he will have a fairly wide latitude in his choice (indeed he may have more than one vehicle at his disposal, rather like the commander

*Continued on page 469*



Heading photograph shows a Battalion Command Car and Commander. The driver is (temporarily) missing.

Right: Headquarters radio truck and crew. The left-hand figure is the Sergeant Major who would properly be with the Battalion C.O. in the Command car (a slight error in setting the group up for photography!).

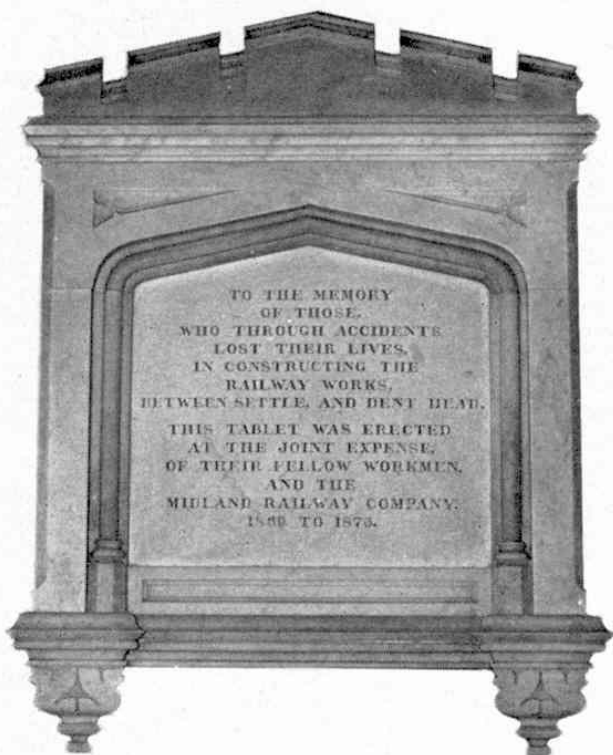

TO THE MEMORY  
OF THOSE  
WHO THROUGH ACCIDENTS  
LOST THEIR LIVES,  
IN CONSTRUCTING THE  
RAILWAY WORKS,  
BETWEEN SETTLE AND DENT HEAD.  
THIS TABLET WAS ERECTED  
AT THE JOINT EXPENSE  
OF THEIR FELLOW WORKMEN,  
AND THE  
MIDLAND RAILWAY COMPANY.  
1840 TO 1876.

Moor, takes on a new meaning. If a gale wind is blowing, a pocket-handkerchief size tarpaulin may be seen to flutter earthwards, torn from a goods wagon. The bog, known as Batty Moss, beneath the piers, had a ghastly appetite for men, horses and building materials. Indeed a special bog-cart was invented, probably with a degree of success but it had to be drawn by luckless horses who would sink in the oozing mud and had to be dragged out by their necks. Around the viaduct, where the traveller may seek refreshment at the ever-welcoming Station Hotel, there was a shanty town, one hundred years ago.

Today there is no sign of the shanty town—it was a true shanty town, in the best tradition of American

### Battle—continued from page 467

of a certain wartime R.A.F. Station, who, I recall, had for his personal use no less than nine aircraft, ranging from a Tiger Moth to a Hawker Typhoon!). One, however, will be enough for us, but again we might be allowed to step a little out of our period and choose the Dodge command car—a first rate little model (Minitanks, that is). Our CO himself can be seen in the photograph. German army enthusiasts are lucky in having the chap with the splendid high-fronted cap—in the Airfix series, I mean, and we must have one who looks just as fine, if we can. Our CO is a bit of a fiddle, in fact, consisting of an Airfix German officer of 1914-18 with the head removed and replaced by a Russian helmeted one. There is no doubt as to who is the commanding officer, I feel. The choice for the second occupant of the command car is open—it can be another officer, the second in command, a sergeant-major or some such, this is up to the wargamer. For my part, I opted for a sergeant-major. Being such an important character, it was felt that he should really be represented by an officer type figure. By the judicious application of a little heat—a compass point warmed in a candle flame was enough—the right arm can be

Left: A stone plaque commemorating those who lost their lives during the construction of the line.

Below: The church of St. Leonard where some of the men are buried.

history—but before moving on, wander up the lane to Ribbleshead Station. A desolate, lonely place where church services were once held in the Waiting Room, and from where the Station Master sends hourly reports to the London weather office. In August and September sheep sales are held on the approach road.

To complete the pilgrimage, move along the road to Chapel-le-dale. Here, in the tiny church of St. Leonard is a conventional memorial, a plaque on a wall commemorating those whose lives were lost during the construction of the local line. There were nameless, numberless men. Many of them are buried in the churchyard, which proved too small, so it was necessary to open an extension to the burial ground. There are at least a hundred labourers buried here, most of the graves being unmarked. Others are known to be buried on the surrounding hills.

A marble memorial is in the church, but their true memorial is the Viaduct spanning the Fells.



gently bent from the shoulder to be left in a less aggressive attitude—one way of identifying the individual figure is to have him in a different position. It saves having to pick him up and peer at him for microscopic insignia. He—the sergeant-major—and the CO, plus the inevitable 'fixed' driver, comprise the occupants of the command car, which, together with the battalion W/T vehicle, form the rudimentary basis for the Headquarters Group to which further additions will be made as we find necessary.

Reconnaissance Group radio jeep and crew.

