

MECCANO LATHE

PART I An advanced model
built and described by
Dutch Reader Dr. J. DE ZEEUW

AMONG METAL-WORKING MACHINES, the lathe is one of the oldest and, at the same time, one of the most interesting to use—a fact which applies equally to model metal-working machines. Meccano makes an ideal medium for a model lathe, but, because vibration is a serious drawback when working with relatively light material, a Meccano lathe requires a very rigid and sturdy construction. This can be achieved by reinforcing nearly all rectangular connections, making quite certain that the connections themselves are at 90 degrees exactly. Moreover, the sliding parts must be strictly parallel and the moving parts must be carefully adjusted, as all unnecessary play causes vibration and this, in its turn, causes inexact work.

The advanced modeller, who does not object to filing and re-shaping some standard parts, will not encounter many difficulties while assembling the lathe featured here, the construction of which is, in fact, rather simple. If the builder proceeds carefully, using only straight and undamaged Angle Girders for the sliding parts, and bearing in mind the above principal constructional requirements, the completed model will give satisfactory results when turning wood or a soft metal such as brass.

Motor and Gear Casing

Construction of the lathe is started with its motor

and gear casing. This part consists of four vertical $9\frac{1}{2}$ in. Angle Girders 1, connected, at the top, by four $5\frac{1}{2}$ in. Angle Girders and, in the third hole from the bottom, by three $5\frac{1}{2}$ in. Angle Girders, as shown. The two lateral Girders are connected by two transverse $5\frac{1}{2}$ in. Angle Girders 2 on which the Electric Motor will later be mounted.

Girders 1 are then further connected through their third holes down, by another four horizontal $5\frac{1}{2}$ in. Angle Girders, the side two of which are themselves joined by a $5\frac{1}{2}$ in. Angle Girder 3. Mounted in the centre of this Girder, and also in the centre of the two Girders on each side of it, are the three bearings 4 of the main shaft 5, these bearings consisting of a $1\frac{1}{2}$ in. Angle Girder and a Double Arm Crank bolted through the slotted holes. Both right-hand bearings are flanked by two other $1\frac{1}{2}$ in. Angle Girders bolted to the $5\frac{1}{2}$ in. Angle Girders to form a sturdy construction. Another similar bearing is bolted to a horizontal $5\frac{1}{2}$ in. Angle Girder 6 fixed to the left-hand side of the casing. As is apparent from the illustrations the casing is reinforced by eight Corner Gussets.

Bolted between Girders 1 at each side is a $5\frac{1}{2}$ in. Flat Girder 7, to which a $4\frac{1}{2}$ in. Angle Girder 8 is fixed. Girders 8 then being connected by a $5\frac{1}{2}$ in. Strip 9 fixed through the second holes of the Girders. Mounted on a Pivot Bolt fixed in the fourth hole of Strip 9 is a Ball Crank 10, to one arm of which two

right-angled Rod and Strip Connectors are fixed. Held in these Rod and Strip Connectors is a 4 in. Axle Rod 12, serving as the stop/reverse lever of the motor-driven lead-screws 68, as will be later described. The Rod rests on a 2 in. Strip 13 that is fixed to Front Angle Girder 8 by means of two inverted $\frac{3}{8}$ in. Bolts. Two additional $\frac{3}{8}$ in. Bolts are fixed in the remaining holes of this Strip, as shown, a Tension Spring 14 preventing the Rod from slipping over the Bolts when it is set in position. A $5\frac{1}{2}$ in. Angle Girder 15 carries the motor control lever, supplied by a $2\frac{1}{2}$ in. Axle rod fixed in a Collar 16, connected to Girder 15 by means of a Bolt. Later, when the Motor is placed into the casing, the motor lever is fixed to a 2 in. Screwed Rod which is locked by a Nut in the bore of a Collar, fixed on the motor reversing lever 16.

The Lathe Bed

Coming to the lathe bed, this consists of four specially-prepared compound angle girders, the upper girders being made up of a pair of compound girders 17, each supplied by three $12\frac{1}{2}$ in. Angle Girders, arranged to form a compound T and E Girder (Diagram 1). The lower slotted side of the E Girder is inserted between those sides of the other two Girders which form the T 'leg'. The two E sides of the compound Girders are facing each other and form the guides along which the loose headstock slides.

Each of the two lower compound girders 18 consists of two $12\frac{1}{2}$ in. Angle Girders that form an inverted T profile. The outer sides of the four T girders are the guides along which the lathe saddle will slide. The upper and lower compound girders are connected at each end by a 2 in. Angle Girder and a Corner Gusset 19, one of the securing Bolts in the case of one of the Corner Gussets at each side helping to fix a 2 in. Strip between the two girders, five holes in from the leg end. The lower end of this Strip is spaced from the lower compound girder by Washers. Journalled in the 2 in. Strips at each side is an Axle Rod 20, carrying Bush Wheel 21.

At this stage, the two outside legs of the bed are assembled before fitting, these being built up from two $5\frac{1}{2}$ Angle Girders 22 bolted to four Flanged Brackets 23, the flanges of which are overlapped

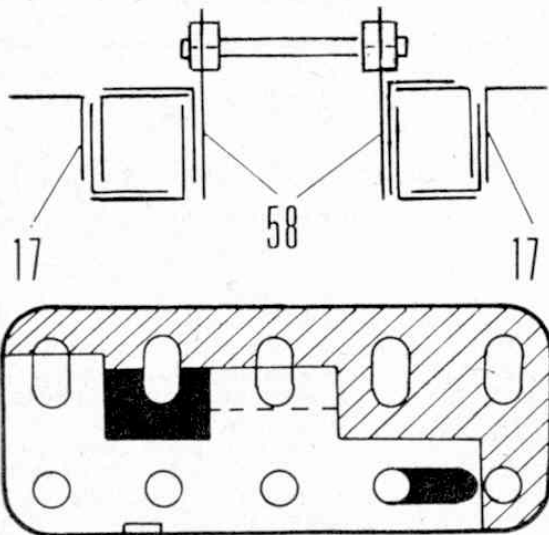

Upper, Diagram 1: A cross-section of upper compound girders 17 and the sliding parts—with Flat Girder 58—of the loose stock-head. Bolts and Nuts are omitted.
Lower, Diagram 2, showing the way in which the side parts of the jaws are filed and sawn. The small upper black part is filed on a slant.

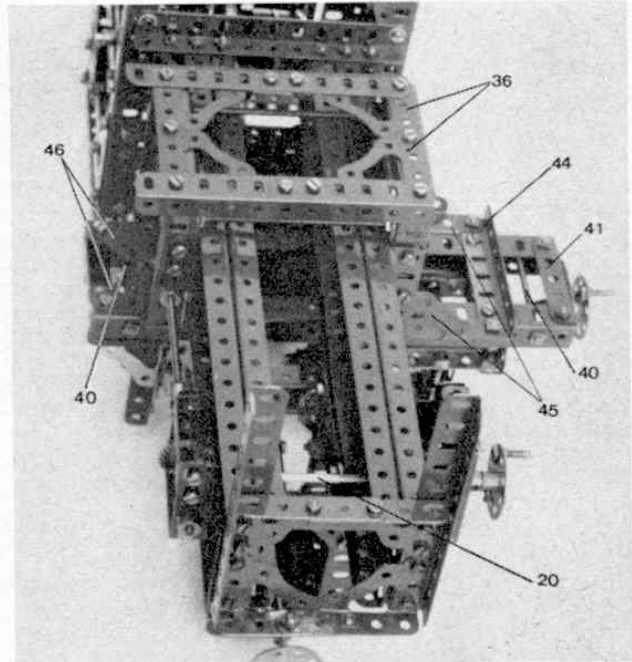

This picture shows construction of the main bed of the Lathe. It is important to ensure that the framework is perfectly rigid and that all angles are exactly 90 degrees.

three holes. Bolted between the fifth hole from the top of the legs is a $3\frac{1}{2}$ in. Angle Girder 24, the second and sixth holes of which must be elongated somewhat, in the direction of the third and fifth holes respectively, by means of a round file, and in these slotted holes the ends of the inner lower bed girders are bolted. Two holes of two $5\frac{1}{2}$ in. Angle Girders 25 are also filed in the same way, the holes here being the fourth and eighth holes, which should be enlarged in the direction of the fifth and seventh holes respectively. Girders 25 are to be fixed at the upper and lower inside ends of the bed.

The legs are now bolted to the bed and, after this is done, great care should be taken to ensure that the compound girders are perfectly parallel, preferably by means of a slide gauge (which may be made of Mee-cano parts if not at hand). The bed is then bolted to the motor casing along with Angle Girders 25. In the centre of upper Girder 25, a $1\frac{1}{2}$ in. Flat Girder is fixed with its elongated holes upward. In these holes a Double Arm Crank is bolted to serve as one of the bearings of Axle Rod 26. *The angle between bed and casing should be exactly 90°.*

The Chuck

An important part of any lathe is the "chuck" which holds the material to be turned. In the model, the chuck is a four-independent-jaw example, the material for turning being centred by the centre point of the main shaft 5 which protrudes about $\frac{3}{8}$ in. through the boss of the 3 in. Sprocket Wheel serving as the front plate of the chuck. General construction of the chuck is apparent from the appropriate accompanying photograph, from which it can be seen that a little "doctoring" of parts is necessary here.

Two 3 in. Sprocket Wheels are each provided with four slots, using a round file, the sprockets first being mounted on a common Rod, bolted together and clamped in a vice. The length of each slot should be 1 in., its width being equivalent to the diameter of a hole.

Each of the four jaws is made of two 2½ in. Flat Girders 28 re-shaped as is shown in Diagram 2. The black parts must be filed off; the hatched parts can be sawn off, and to ensure that the modifications are identical on all four Girders, they should be carefully bolted together and filed and sawn as one unit. Approximately ¼ in. is next cut off each of four Cores for Cylindrical Coils (electrical Part No. 528) the Cores then being provided with two threaded transverse bores by means of a ⅜ in. tap the distance between the centres of these bores being 1/16 in. When this has been done, the cores are tightly clamped between two of the re-shaped Flat Girders 28, to form the side parts of each jaw, by means of four Grub Screws 29 and Washers bolted in the transverse bores of the Cores. The central or lower Grub Screws are bevelled by filing in order to prevent blocking of the jaws when these are screwed to the centre. It will be seen from the accompanying photograph that each pair of re-shaped Flat Girders is bent round the respective Cores. The correct shape is obtained by forming the Girders round the Cores, using Nuts and Bolts to apply force, first inserting a Washer between the Girders on each of the Bolts. Both ends of a jaw must be in a direct line with each other, so some re-bending with pliers will be necessary in most cases. After this is done, the bolts used for bending are removed.

If a tap is not at hand to thread the Core, as mentioned above, an alternative although less rigid method of construction is to file two slots in the Cores, in which Flat Girders 28 are inserted. The slots should, of course, be filed very carefully to keep "play" to an absolute minimum and, if this method is used, the centre of each Girder 28 should be sawn off as indicated by the dotted line in Diagram 2.

If one thinks slotting of the two 3 in. Sprocket Wheels tiresome, two 3½ in. Slotted Gear Wheels may be used, the size of which is however somewhat less suitable, and the construction a little less sturdy.

Next, four 3½ in. Strips 30 are bent as shown to form double brackets, this again being done very carefully to ensure that all four are identical. If this is not the case, the Chuck will swing on its shaft. The length of each double bracket lug is 1/8 in., the centre hole of the Strip of course serving as the centre point of the bracket.

A 4-hole Collar 31 (electrical Part No. 140Y) is now "doctored" by drilling out the threads of the transverse bores with a ⅜ in. drill. This Collar will serve as the central support for four 2 in. Screwed Rods 33

which will be screwed into the longitudinal bores of Cores 27.

Now the chuck can be assembled. First double brackets 30 are fixed to one of the two slotted Sprocket Wheels, mounted boss inwards, using four standard Bolts in the inner round holes and four 2 in. Screwed Rods, shortened by ½ in. in the outer round holes. The Rods, however, may be replaced by suitable commercial bolts, as in fact, is the case with the model shown. The four jaws are then inserted in the slots of the Sprocket, after which Screwed Rods 33 are screwed through the longitudinal bores of Cores 27 and into a 4-hole Collar 31. A 2½ in. Rod is used temporarily for centring this Collar, the Rod being mounted in the boss of the slotted Sprocket Wheel after suitable spacing Washers have been added.

PARTS REQUIRED

1-2	2-27a	1-103d
1-5	4-30	14-103f
2-6	2-30a	4-103g
10-8	2-30b	9-103h
8-8a	2-31	18-108
22-9	1-32	10-111
4-9a	285-37a	7-111a
23-9b	375-37b	8-111c
25-9d	34-38	4-115
8-9e	1-38d	1-115a
9-9f	1-51	2-116
2-11	18-59	2-116a
1-13a	5-62	2-123
2-14	2-62a	6-126a
2-14a	6-62b	1-128
1-15a	2-63	14-133
2-15b	4-63c	4-133a
1-16b	6-64	6-136a
1-17	2-72	2-139
2-18a	3-79	2-139a
2-18b	4-80b	1-140y
1-19b	8-80c	1-147b
1-23a	11-81	1-179
4-24	2-90a	2-212a
1-26b	2-95b	9-215
3-26c	2-103	4-522

1—E.15R Electric Motor.
1—Eclipse Tool.
Suitable Drive-belt.

To be continued

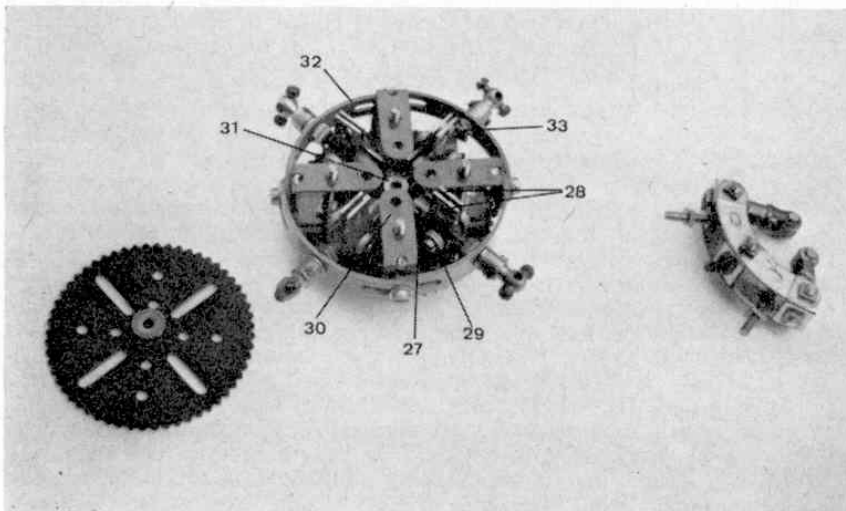

The chuck, partly dismantled to show construction of the jaws.

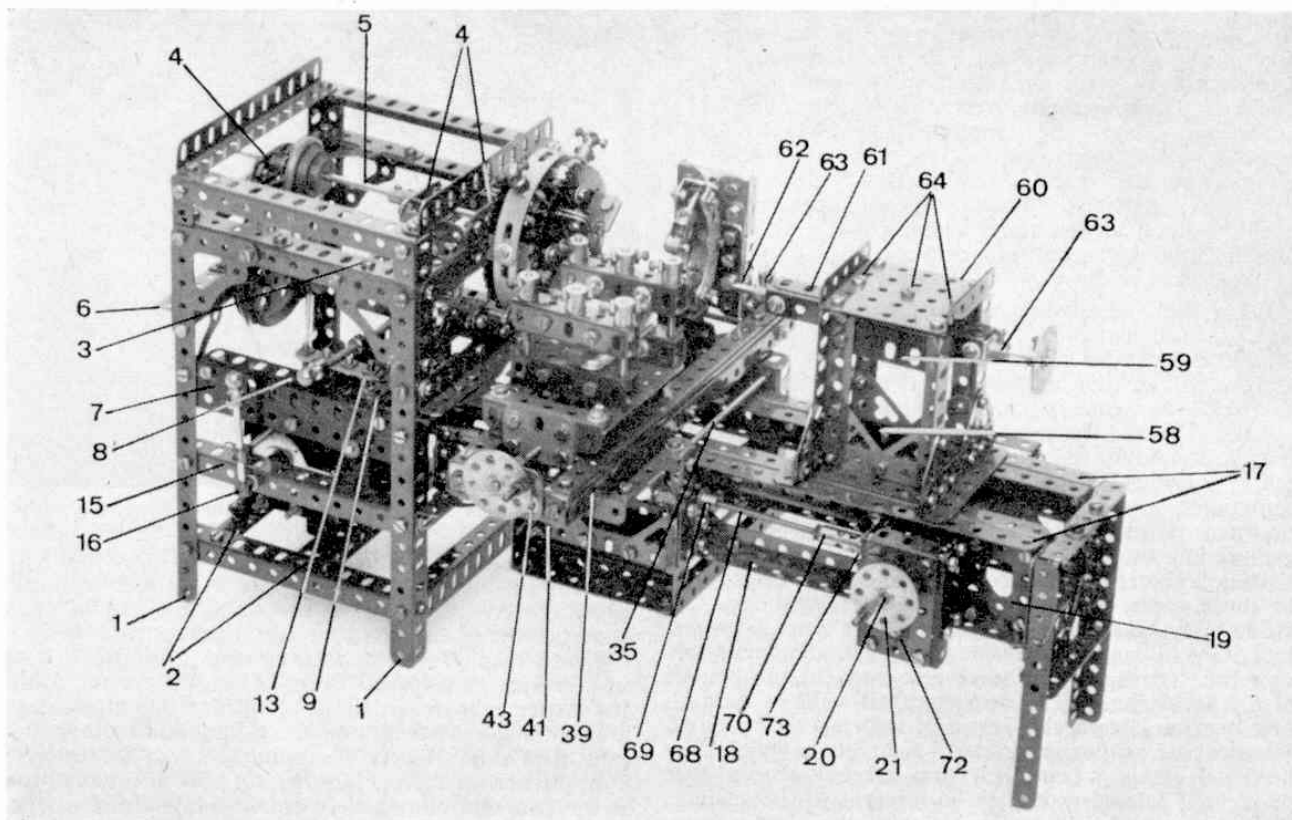

MECCANO LATHE Part II

*An advanced model described by
Dutch reader Dr. J. DE ZEEUW*

IN THE FIRST part of this article last month we covered construction of the Lathe bed and motor/gearbox casing, but were just unable to finish the description of the chuck. To continue where we left off, therefore, each Screwed Rod 33 is then fitted with two Nuts, a Washer, two Formed Slotted Strips 32, one or two Washers and a Handrail Coupling in which two Grub Screws are fastened. Note that the Screwed Rods 33 are screwed as far into the bores of Collar 31 as possible without fouling the $2\frac{1}{2}$ in. Rod. Formed Slotted Strips 32 are bolted to brackets 30, while the two Nuts on each of the Screwed Rods are in turn tightly locked against the Formed Slotted Strips. The second slotted Sprocket Wheel is now fixed to the rear of the chuck, its boss pointing outward, then the Flat Girders forming each jaw are bolted together with a spacing Washer between them. If necessary the Nuts joining the rear parts of each jaw should be filed off

a little bit, and Grub Screws could be used in place of normal Bolts.

It is worth mentioning, here, that if materials of small diameters are to be turned on the model the jaws can be made longer by replacing the spacing Washers between each pair of Flat Girders 28 with a small Strip such as the largest piece previously sawn off the Flat Girders. The width between the jaws should not exceed $\frac{3}{4}$ in.

The main shaft 5, supplied by an 8 in. Axle Rod, is provided with a 60° point, which is done with a grinding machine. While grinding, the Rod should be turned regularly at not too low a speed, and note it is essential that the point be *exactly* in the centre. Finally, this shaft which carries also a Cone Pulley, is journalled in the upper three bearings of the motor casing 4, then the chuck is fixed on this shaft by two Grub Screws in the boss of the rear Sprocket Wheel.

Saddle and Cross Slide

Coming to the part known as the "saddle" which slides along the length of the lathe bed, this is built up from two square frames 34, assembled from $3\frac{1}{2}$ in. Angle Girders, the two frames being connected by four $4\frac{1}{2}$ in. Screwed Rods 35 and two $5\frac{1}{2}$ in. Angle Girders, as is shown in Fig. 5. The connections between the frames and the $5\frac{1}{2}$ in. Girders are reinforced by Corner Gussets 36, while the corners of the frames themselves are made rigid by four 1 in. and four $1\frac{1}{2}$ in. Corner Brackets, two to each frame.

Fixed to the inside of each frame, one to Girder 37 and the other between the side Girders of the frame, are two special runners, each built up from a $2\frac{1}{2}$ in. Angle Girder and $3\frac{1}{2}$ in. Angle Girder bolted together to form an "F" profile, between the arms of which the outer edges of the bed are held. The upper slide is secured in place by appropriate Screwed Rods 35 and two separate Bolts and Nuts by which the space between the Girders of the "F" construction can be adjusted, as also is the lower slide, numbered 38 in Fig. 2. By using Screwed Rods 35, the width of the saddle can be precisely adjusted to the width of the bed. At the same time, the space between the sliding Girders can be adjusted with the fixing Bolts, so that the saddle runs smoothly and with the least amount of play along the bed.

This adjusting and spacing is critical for good functioning of the lathe, but, before making any final adjustments the cross-slide should be mounted on the top of the saddle. The cross-slide moves on two $9\frac{1}{2}$ in. "U"-section Girders 39, each built up from two $9\frac{1}{2}$ in. Angle Girders. From the illustrations it will be apparent where slotted and where circular holes are

used. The "U"-section girders are connected at each end by a 3 in. Screwed Rod 40 and a $2\frac{1}{2}$ in. Angle Girder 41, the Girder at one end being attached by Angle Brackets, while the other Girder is bolted directly in place. The former Girder also carries a set of two $1\frac{1}{2}$ in. Flat Girders 43, one bolted to the other, then construction is reinforced by a $3\frac{1}{2}$ in. Angle Girder 44, which rests on two Flanged Brackets 45, and by four $1\frac{1}{2}$ in. Corner Brackets 46.

As in the case of the saddle, both slides for the cross-slide are again built up from a $2\frac{1}{2}$ in. Angle Girder 47 and a $3\frac{1}{2}$ in. Angle Girder arranged to give an "F" profile. Each slide is bolted to a $3\frac{1}{2}$ in. Angle Girder 48, then the two are connected by two 2 in. Screwed Rods 49 (Fig. 2) which also serve for spacing purposes. On to this assembly is fixed a $2\frac{1}{2} \times 2\frac{1}{2}$ in. Flat Plate 50 and the tool holders, the latter being built up from eight $2\frac{1}{2}$ in. Angle Girders 51, bolted together in pairs (using $\frac{3}{4}$ in. Bolts in the second and fourth holes) to give four rectangular 'tubes'. The bolting is done with three Nuts, two inside each 'tube' and one outside. The tubes are mounted in pairs, as shown, on six $3\frac{1}{2}$ in. Screwed Rods and it is between the tubes that the cutting tool is clamped by six Threaded Bosses 52, in which Set Screws are locked by Nuts.

At the front end of the cross-slide, a $2\frac{1}{2}$ in. Angle Girder 53 is fixed, the height of which is adjusted by spacing Washers. To this Angle Girder a pair of $1\frac{1}{2}$ in. Flat Girders is bolted, a Nut being sandwiched between them. Through this Nut an 8 in. Screwed Rod 54 is screwed and, at the front end of this Rod,

Fig. 2, showing construction of the saddle and cross slide, with one of the controlling leadscrews.

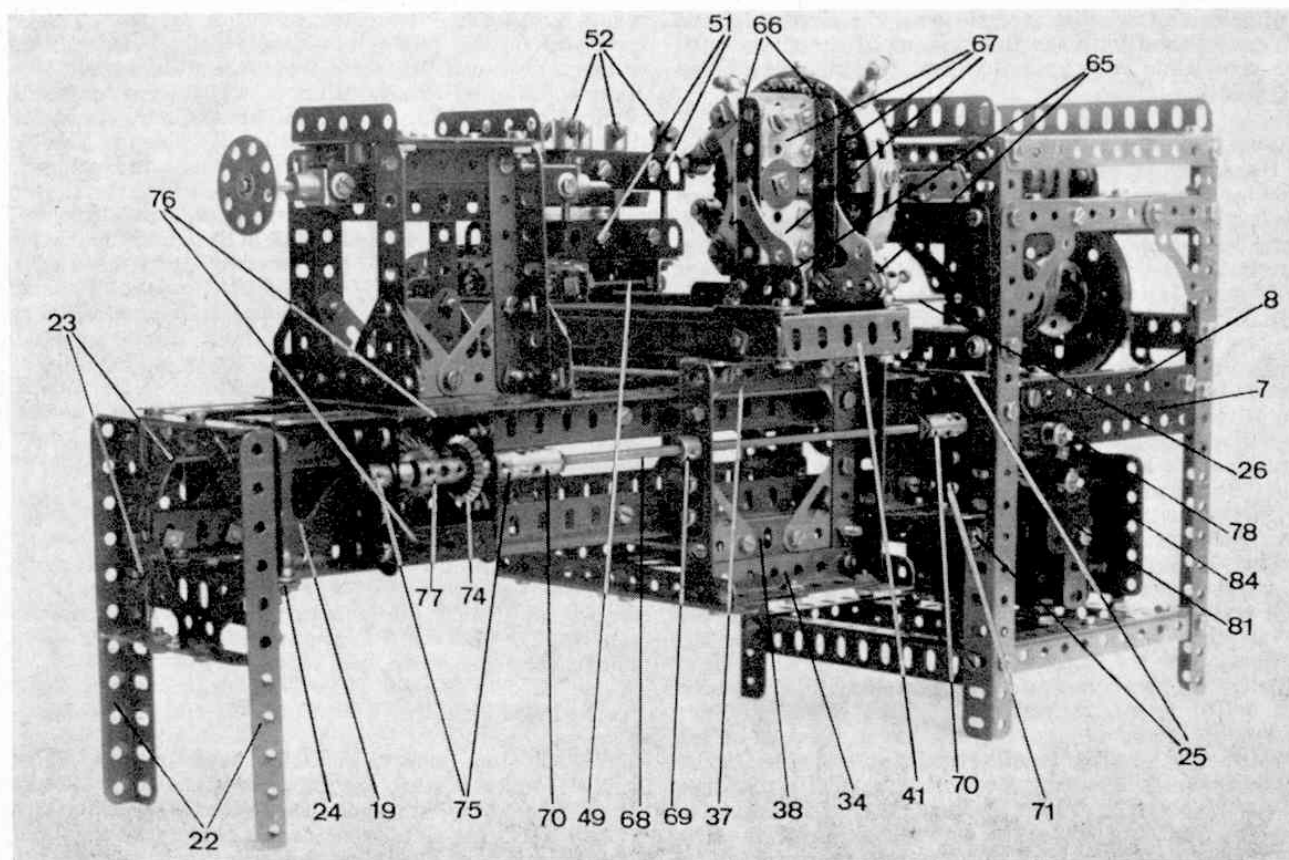

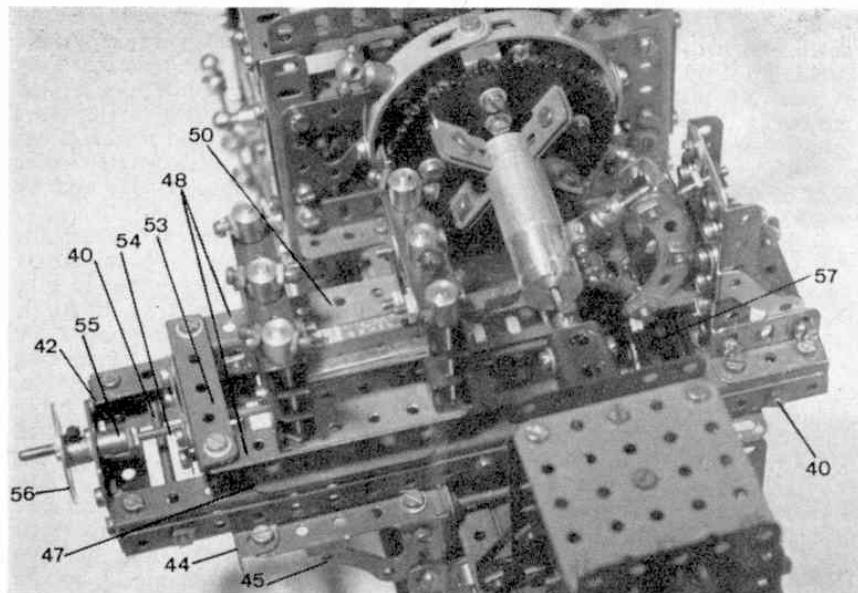

Fig. 4. A close-up view of the cross slide with the Lathe set up for operation.

an Adaptor for Screwed Rod 55 is mounted and locked in place by a Nut. This Adaptor carries a Bushwheel 56, by means of which the cross-slide can be moved forward and backward. If there is too much play, here, a second Nut can be inserted between the two Flat Girders. The rear end of Screwed Rod 55 is journalled in the central hole of $1\frac{1}{2}$ in. Flat Girder 57, being held in its position by a Nut locked against the Girder. This Girder is fixed to a $2\frac{1}{2}$ in. Angle Girder that, in its turn, is fixed in the fifth hole of the two lower "U"-Section Girders 39. Here, again, adjusting and spacing is done with the Screwed Rods 40 and 49 and with the fixing Bolts of the slides until the cross-slide runs smoothly and without play along its guides.

Loose Headstock and Steady

Construction of the loose Headstock will be apparent, for the greater part, from the illustrations. Moved by hand, it slides along the inner edges of the bed, the actual slides each being provided by a pair of $2\frac{1}{2}$ in. Angle Girders which enclose the flange on the relevant bed Angle Girder. Bolted to each slide is a $2\frac{1}{2}$ in. Flat Girder 58 and two $1\frac{1}{2}$ in. Corner Brackets, then the two slides are connected by two 2 in. Screwed Rods, fixed, together with the Corner Brackets, in the slotted end holes of Flat Girders 58. These Rods, again, serve for spacing purposes. The superstructure is built up from four vertical $3\frac{1}{2}$ in. Angle Girders, the two Girders at each side being joined by two $2\frac{1}{2}$ in. Flat Girders 59 and two $2\frac{1}{2}$ in. horizontal Angle Girders, the latter at the top of the Girders. Bolted to the latter Girders at each side are another two $2\frac{1}{2}$ in. Angle Girders and a $2\frac{1}{2} \times 2\frac{1}{2}$ in. Flat Plate 60. The sides of the headstock are joined at the base by two transverse $3\frac{1}{2}$ in. Angle Girders, the joins being strengthened by four Flat Trunnions.

Serving as the centre point shaft 62 is a $6\frac{1}{2}$ in. Rod mounted in the bosses of two Large Fork Pieces which are bolted to an inverted $4\frac{1}{2}$ in. "U"-Section girder 61, built up from two $4\frac{1}{2}$ in. Angle Girders. This assembly is secured to the top of the headstock by three $\frac{1}{2}$ in. Bolts 64, spaced by three Collars and as many Washers or Thin Washers as are necessary to get this shaft in a direct line with the main shaft. The alignment is very critical for the good functioning of

the lathe.

In operation, the headstock would of course be bolted to the bed and, when thus secured in place—particularly at the limits of its travel—the distance between the centre point shaft and the main shaft can be varied up to one inch by altering the position of "U"-Section girder 61 in its mounting. The centre point shaft itself may also be used for fine adjustment of the distance between the two shafts, so that a pretty good range of distances is available.

To compensate the pressure exerted on the material while turning and to reduce vibration, a steady rest is mounted on the guides of the cross-slide. Its general construction can be seen from the illustrations. A Formed Slotted Strip (Fig. 3, right-hand part) is flanked by two $2\frac{1}{2}$ in. Stepped Curved Strips, to which it is attached by means of three $\frac{1}{2} \times \frac{1}{2}$ in. Double Brackets, fixed by one standard Bolt through the centre hole and a $\frac{3}{8}$ in. Bolt through each of the slotted holes. The complete rest is then secured to a support, consisting of two $1\frac{1}{2}$ in. Angle Girders 65 and two $2\frac{1}{2}$ in. Angle Girders 66 connected by three $1\frac{1}{2}$ in. Flat Girders 67, and reinforced by two Flanged Brackets. Rollers are supplied by Collars, fitted with $7/64$ in. Grub Screws, on a short length of Rod, mounted in Small Fork Pieces. These rollers can be adapted to the diameter of the material to be turned, since they are secured to Threaded Pins or, if necessary, to Long Threaded Pins. To remove all danger of damage to the turning material a piece of plastic tube can be glued round the Collars.

Motor and Gearing

Both the saddle and cross-slide are moved along the bed by means of two 8 in. Screwed Rods, the lead-screws 68, which are screwed through two Threaded Cranks 69, one fixed to the saddle by a $1\frac{1}{2}$ in. Flat Girder, and the other fixed directly to a vertical $3\frac{1}{2}$ in. Angle Girder, as shown. A Threaded Coupling 70 is screwed and locked by a Nut on each end of each lead-screw, a $1\frac{1}{2}$ in. Rod being fastened in each of the two Threaded Couplings nearest the motor casing. These latter Rods pass through the second hole of a 2 in. Flat Plate 71 and through the boss of a Crank which is bolted to this Girder inside the motor casing. This Flat Girder and Crank assembly is fixed to the 2 in.

vertical Angle Girders on each side of the bed.

The small gear casing on the right front or operators side of the lathe, the so-called (fixed) apron, consists of a $2\frac{1}{2} \times 1\frac{1}{2}$ in. Flanged Plate to the front of which a Crank 72 is bolted and to each side of which, a $2\frac{1}{2}$ in. Angle Girder extended by a 2 in. Flat Girder is fixed. The casing is then fastened to the bed by two 2 in. Angle Girders. In order to allow adjustment of the leadscrew, full use should be made of the slotted and circular holes in both the Angle and Flat Girders of this casing. The gearing, itself, consists of two $\frac{7}{8}$ in. Bevel Gears, one of which is fixed on a $1\frac{1}{2}$ in. Axle Rod fixed in Threaded Coupling 70 and journaled in the boss of a Double Arm Crank 73, bolted to the casing. The other Bevel Gear is mounted on a $5\frac{1}{2}$ in. Axle Rod 20 which is journaled in the holes of the 2 in. Strips already secured to the bed, as described above. Inside the casing Rod 20 carries a Coupling, the centre transverse bore of which serves as a bearing for the $1\frac{1}{2}$ in. Rod.

On the "rear" side of the lathe a similar casing is mounted, as is shown in Fig. 2. Bevel Gear 74 is fixed on a $2\frac{1}{2}$ in. Axle Rod which is journaled in the bosses of two Cranks 75, then the two sides of the casing, each consisting of a 2 in. Angle and a 2 in. Flat Girder, are connected by two $1\frac{1}{2}$ in. Double Angle Strips 76. The central transverse bore of Coupling 77 serves as the end-bearing of Rod 20.

Before the gearing of the motor casing is assembled, two $2\frac{1}{2}$ in. Angle Girders are bolted to one motor side-plate, a $2\frac{1}{2}$ in. Flat Girder, in turn, being bolted to one flange of each of these Girders. Bolted between the Angle Girders, through their upper holes, is a $3\frac{1}{2}$ in. Flat Girder.

On each of the Rods fastened to the two leadscrews inside the motor casing, a $1\frac{1}{4}$ in. Bevel Gear is fixed. These Gears are in constant mesh with two $\frac{1}{2}$ in. Bevel Gears 79 on Axle Rod 78, this Rod also carrying a $1\frac{1}{2}$ in. Gear Wheel 80. A Worm 82 on the output shaft of the Motor is in mesh with a $1\frac{1}{2}$ in. Gear Wheel 83 on a Rod 84 which also carries a $\frac{1}{2}$ in. Pinion 85 and a 1 in. Gear Wheel. An "idler" $\frac{1}{2}$ in. Pinion 86 turns freely on a $\frac{3}{4}$ in. Bolt held by Nuts in one Flat Girder 81, then a slideable $4\frac{1}{2}$ in. Axle Rod 87 is mounted in the upper holes of Flat Girders 81. Fixed on this Rod, from right to left, are $\frac{1}{2}$ in. Pinion, a free-moving Collar, in the threaded bore of which a Long Threaded Pin 88 is lock-nutted, a fixed Collar, a 1 in. Gear Wheel and a $\frac{1}{2}$ in. Pinion with a $\frac{3}{4}$ in. face 89. Stops for the sliding movement of the Rod are supplied by Collars at both its ends, while the movement, itself, is controlled by lever 8, the Bell Crank of which moves Threaded Pin 88. The arm of this Bell Crank is held between two Collars fixed on Threaded Pin 88.

At this point the Motor, with gearbox, is mounted on the two transverse Girders of the framework, using four $\frac{1}{2}$ in. Bolts with three Nuts on each of them, so that the Motor can be adjusted in order to ensure that Pinion 89 meshes with Gear Wheel 80. On the other side of the Motor, a $\frac{1}{2}$ in. Pulley with Boss is fixed on the output shaft, then a 3 in. Pulley 90, screwed to a Bush Wheel, is mounted, together with a Cone Pulley, on $5\frac{1}{2}$ in. Rod 26. On the model illustrated, final transmission was by commercially-produced plastic belting, but suitable small Vee-Belts could be used, or standard Meccano Driving Bands. Alternatively, instead of a pulley and belt transmission system, Sprockets and Chain could be used, although somewhat more noisy.

In adjusting the model for operation, it is important

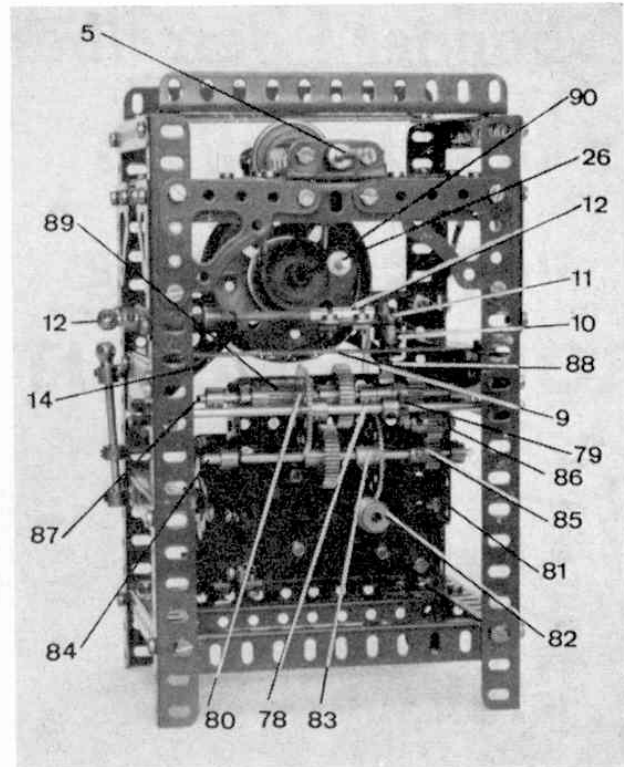

Fig. 6. The Motor and gearing, in their framework, removed from the remainder of the Lathe.

to remember that the $1\frac{1}{2}$ in. Bevel Gears on the shafts of the leadscrews and also the $\frac{7}{8}$ in. Bevel Gears on Rod 20 must be synchronised with each other to avoid uneven driving of the saddle.

Using the Lathe

After all moving parts have been carefully adjusted and lubricated, the lathe can be given its first trial. A suitable, cylindrical piece of wood or brass is provided with centre holes in both its ends by a centre drill. This must be done very precisely; exactly in the centre of the material. The piece of wood or brass is then fixed between the centre points, as is shown in Fig. 4, and then carefully clamped between the jaws. Before the actual turning is done, however, the working of the lathe, and especially the centring of the material, should be double-checked.

The tool used in the model shown is a $3\frac{1}{2}$ in. Eclipse chisel, the upper point of which *must* be at exactly the same height as the centre points—something which can be achieved by packing an appropriate number of $2\frac{1}{2}$ in. Strips under the tool. On the other hand, the tool need not necessarily be fixed at right-angles to the material being turned, but could just as well be clamped at an obtuse angle to the material. Turning lengthwise is done either by hand or by motor and transverse turning, or feeding, is done by moving the cross-slide into the direction of the material. This feeding should be done very carefully to avoid heavy vibration.

It is very probable that readjustment of several parts must be done, before the lathe turns satisfactorily. Modellers not sufficiently acquainted with lathes and turning are advised to read MAP-publications No. 52: "The Beginners Guide to the Lathe" and No. 32: "Using the Small Lathe".