

MECCANO CONSTRUCTORS GUIDE

Part 5: Rotating Superstructures by Bert Love

BRADLY SPEAKING, rotating superstructures can be placed into one of three categories as follows:

- (1) Static balanced structures, such as gun turrets and roundabouts.
- (2) Counterweighted structures, such as hammerhead cranes and,
- (3) Pivoting structures which swing around a mast, such as tower cranes.

Swing bridges and locomotive turntables fall into the first category which is concerned with rotating structures which are more or less permanently balanced and are therefore fairly simple in design. A large roller path is provided in the form of a ring and a central pivot post is anchored to centralise the rotating structure. In many cases the stability of such turntables is provided purely by gravity from the sheer weight of the revolving

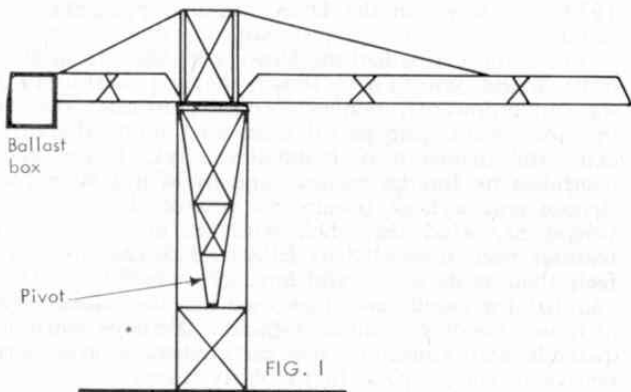
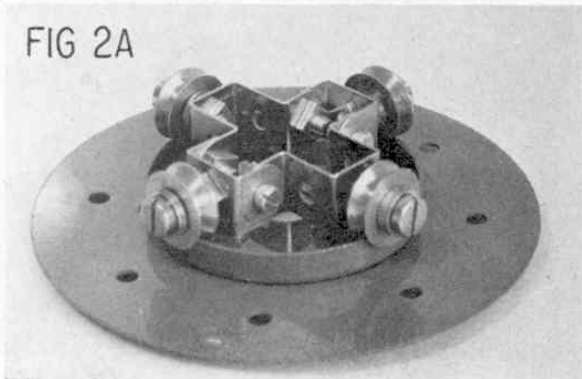

Diagram of a tower crane employing a rotating mast.

mass. A classical case of this is illustrated in the scuttling of the German Grand Fleet in Scapa Flow, after the 1919 Armistice. When the great Battleships and Cruisers were salvaged they were found to be without their heavy guns. When the ships capsized and turned turtle, the gun barbets simply fell out of their deep circular wells, where they simply rested on roller bearings, and plunged to the bottom of the ocean. Although the fairground roundabout is, generally speaking, a balanced rotating structure, many traditional types did pivot about a central mast and to maintain smooth running, a good fairman, in loading his machine,

FIG 2A



A miniature roller bearing used at the foot of a crane mast.

especially with heavy adults, would see that they were equally distributed round the 'ride'.

The two diagrams Fig. 1 and Fig 1a (not to scale) illustrate cranes that fall into the second two categories. In the first diagram we see the general outlines of a tower crane which represents those types which make use of a central mast for their rotation of the long boom. The tapered mast which runs down through the tower is pivotted in a fixed bearing, as shown, and this often takes the form of a phosphor bronze pad. It is important to realise that, in such a crane, the entire weight of the rotating structure is carried by the bearing at the foot of the mast and a roller ring situated at the break of the tower is a very light-duty affair which supports only the lateral, or sideways 'lean' of the crane when under load. This system has the advantage of being safe; requires no heavy components; can be made up from light-weight lattice components and absorbs both wind displacement and 'whipping' of the crane boom under awkward load conditions or jarring. The tilting moment from the load (or ballast box) is also transmitted to the foot of the mast so that the tower contributes to the general stability of the crane and must be designed and anchored accordingly.

After considerable wear, the phosphor bronze bearing is replaced by 'jacking up' the mast, the upper roller race being designed to allow its rollers to move vertically, and a new bearing inserted. This type of crane is

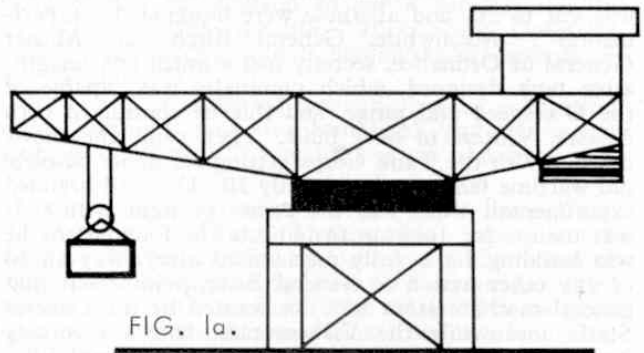

Diagram of a block-setting or hammerhead crane employing a heavy turntable and platform.

very easy to build in Meccano, the pivot at the foot of the mast being provided by a Meccano Steel Ball, Part No. 168d, trapped in the sockets of a pair of Socket Couplings, Part No. 171, one of which is secured to the foot of the mast and one to the base girders of the tower. The upper roller race to take the lateral thrust can be made from any of the Meccano Circular Strips or Circular Flange Rings, against which six or eight Flanged wheels are set to roll round on the inside. Fig. 1a represents the heavy type of crane which is a familiar sight in ports and dockyards and is well known as a favourite type of modelling by the advanced enthusiast. This type of crane requires quite a massive roller bearing because of the sheer physical weight of the rotating superstructure plus the very heavy loads which these giants can handle. Even larger and heavier turntables are used by the World's largest Draglines which literally 'sit' on their own roller bearings and drag

them across the face of the earth.

In considering the reproduction of the various turntables found in engineering practice, the Meccano Constructor must use his ingenuity to overcome problems within the limits of the parts at his disposal. Referring back to the tower crane, one problem which does arise is the supply of power to the cab controls when it is necessary to pass a cable up through the crane mast. Obviously a hollow pivot bearing is required and Fig. 2 shows how this can be done. One of the neatest and smallest thrust roller bearings which can be built in Meccano is shown in Fig. 2a which has the excellent advantage of being completely self-centring. The lower part of this bearing is a Wheel Flange, Part No. 137, bolted to a Circular Palte. As both of these parts have a substantial hole in the centre, a generous size of multicore cable can be passed right through the

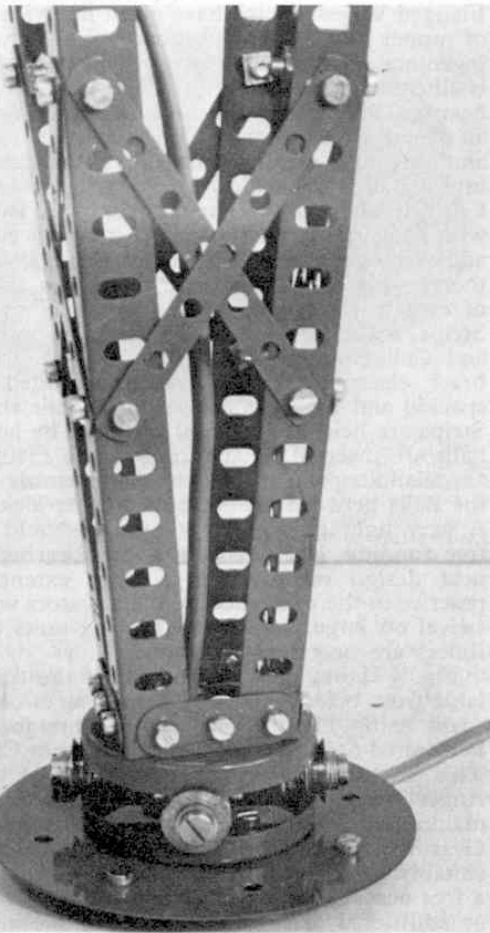

FIG 2

A hollow pedestal-bearing for the foot of a crane mast, through which a power cable is fed.

middle of this neat little roller bearing without impairing its efficiency. The foot of the crane mast is fixed to a second Wheel Flange by Angle Brackets, as shown, and the whole mast can then be rotated by a suitable drive at cab level, or by attaching a $3\frac{1}{2}$ in. Gear Ring, Part No. 180, to the foot of the mast.

Moving up a little in size, we come to the purpose-made Ball Thrust Bearing, Part No. 168. This is a versatile component as its three parts can be used independently and Fig. 3 shows an exploded view of a built-up Ball Bearing on a model of a mobile crane. Only the top section and actual Ball-race of the bearing are used in this case, the lower flange being replaced by a $3\frac{1}{2}$ in.

Gear Wheel. The parts shown in Fig. 3 are separated for clarity but, in action, the top flanged would cover the Balls which, in turn, would ride on the flat surface of the large Gear Wheel. The hand wheel driving the slewing Pinion would be replaced by a mechanism inside the cab of the crane, of course. A Bearing of this nature must have an Axle Rod passing up through

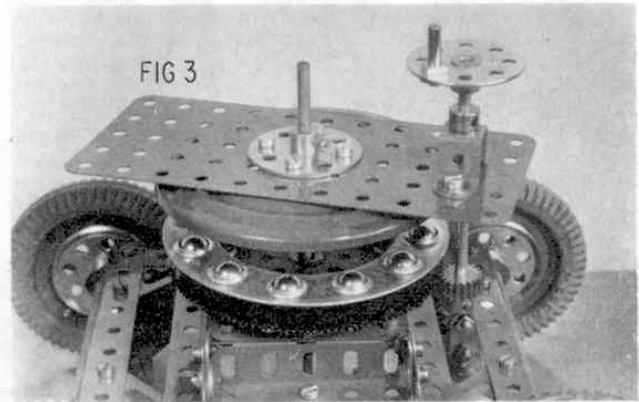

FIG 3
An "exploded" view of a ball bearing for a model mobile crane. All three parts of the bearing are in contact when operating.

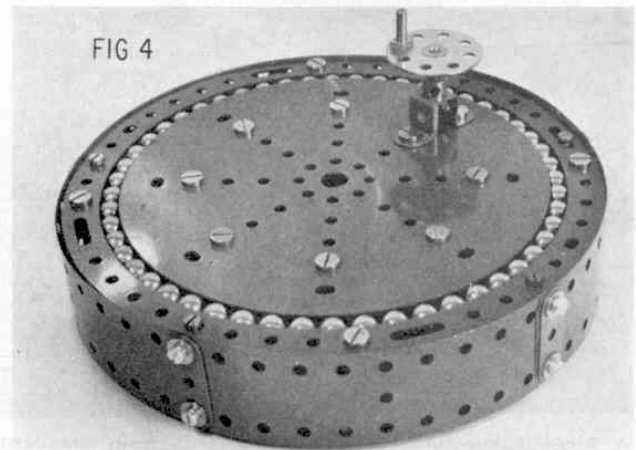

FIG 4

A built-up flush-level multi-ball turntable. Pivot Bolt construction ensures essential concentricity.

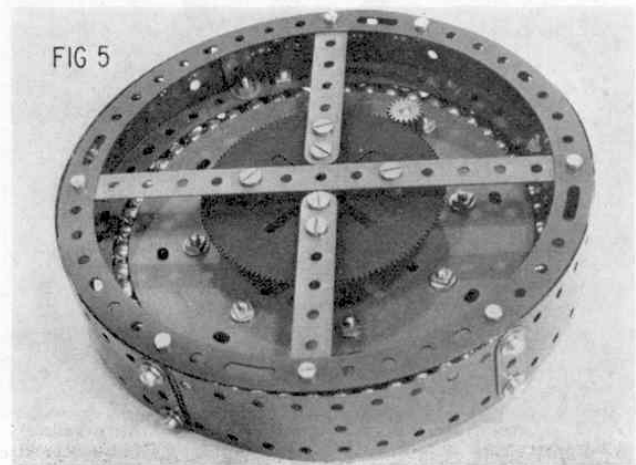
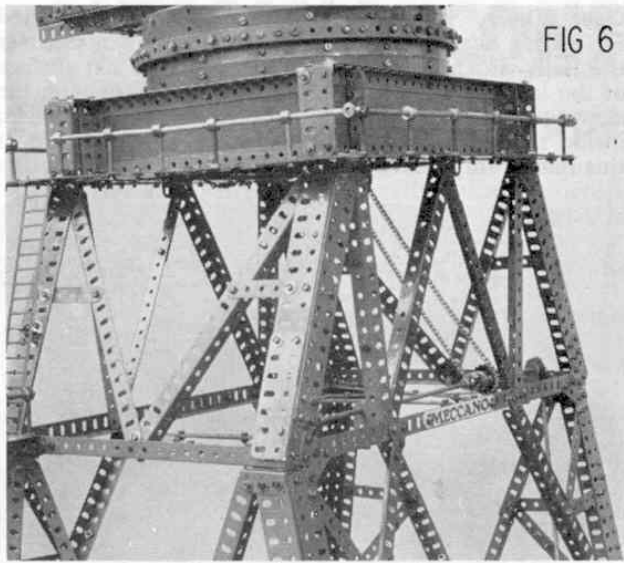
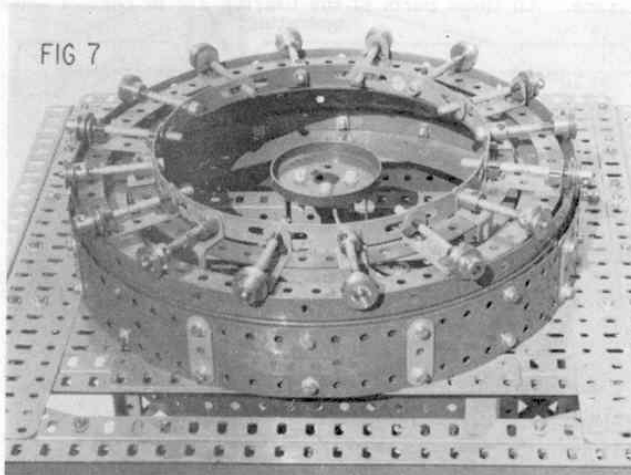

FIG 5

An underside view of the mechanism shown in Fig. 4 illustrating the location of the $3\frac{1}{2}$ in. slewing gear.



A good example of a tower design to support a heavy crane turntable.



A large heavy-duty roller bearing built from standard Meccano Parts. The centre Wheel Flange is used as a current collector.

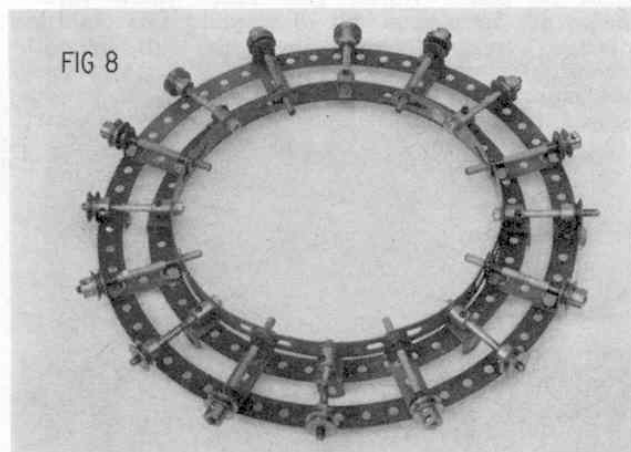

A lightweight "hollow" centre spider with alternate "floating" rollers. All rollers are free-running and are located entirely by the centralising action of the large Flanged Rings.

its centre to centralise the whole bearing and a suitable locking device, such as Collars or Bush Wheels, must be added to prevent the bearing from lifting apart under load conditions. This can be quite a serious disadvantage to the model builder who takes his turntable design seriously and he would aim to fit 'hook rollers' to his model, as is frequently done in full-size prototypes. Hook rollers are often fitted to excavators and similar machines which have a natural tendency to tilt when they are removing stubborn soils and rocks. The purpose of such rollers is to hook underneath the bottom of the turntable ring and to 'pick up' the turntable bodily if the machine starts to tilt.

Many average-size turntables for models have been published in Meccano Magazine from time to time, utilising the 5½ in. Circular parts as roller rings or flanges but few have employed hook rollers, if any, and many have been out of proportion due to the use of Flanged Wheels which have given too wide a separation of upper and lower portions of the turntable. An ingenious method of overcoming these disadvantages is illustrated in Fig. 4 and Fig. 5 which show a ball bearing, the essential features of which do not exceed an overall depth of ¾ in. Construction requires patience and care and the insertion of 52 Meccano Steel Balls into a Ball Race made from 7½ in. Circular Strips and 6 in. Circular Plates. The two Plates are locked together with Pivot Bolts, as shown, to ensure accurate register and each one carries a Collar for critical spacing between the two Plates. Collars *must* be chosen with care to be of exactly the same length. In spacing the Circular Strips, Pivot Bolts are again used for accurate register and Collars are used for spacing, but, this time, one brass electrical Thin Washer is added for critical spacing and the Balls are inserted while the Plates and Strips are held in a vertical plane. The last half dozen balls are inserted by slacking off one Pivot Bolt in the Circular Strips at the top of the assembly and pushing the Balls between the Strips before re-locking the Bolt. A very light greasing (not oiling) should then give a free running, but not sloppy, ball bearing. This very neat design conforms to a large extent to modern practice in the construction of excavators which actually swivel on large, sealed ball bearing units and no hook rollers are necessary of course.

Fig. 5 shows the construction of the complete turntable from below. A 3½ in. Gear ring is centrally fixed, again using Pivot Bolts and Collars for spacing, to Perforated Strips attached to the bottom Circular Strip. This, in turn, is secured to the wall of the drum by Angle Brackets and care must be taken at this stage to maintain the 3½ in. Gear Wheel quite centrally. The Gear Wheel could be replaced with a 3½ in. Gear Ring suitably attached, when the bearing would then have a free access hole right up through its centre for cable or additional drive shafts to upper mechanisms.

As the Meccano turntables get larger, substantial bases are required to support them and Fig. 6 shows an excellent type of structure for this purpose in which heavy-section built-up girders are put to good use in providing a strong platform for the turntable.

A typical basic construction for the larger roller bearing is shown in Fig. 7. Three 9½ in. Flanged Rings are used, two of them forming supports for the drum wall, made of three layers of 5½ in. × 1½ in. Flexible Plates. These are stood off from the Rings by double washers and overlaid with 1½ in. Perforated Strips. The Wheel flange mounted in the centre of the bearing is stood off by electrical Insulating Bushes to provide an electrical slip ring feed to the revolving superstructure. Fig. 8 shows how simply the 'spider' is made. The outer ring is made of eight 4½ in. Stepped

FIG 9

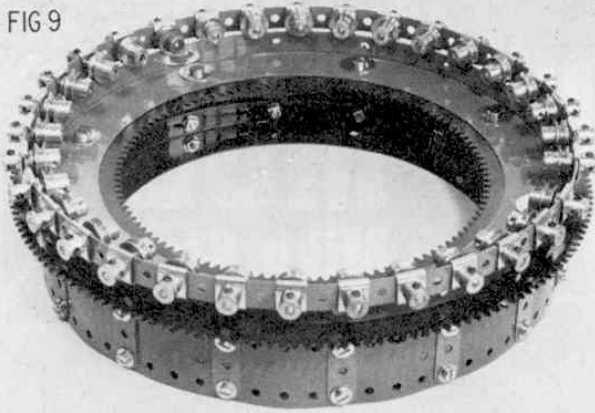
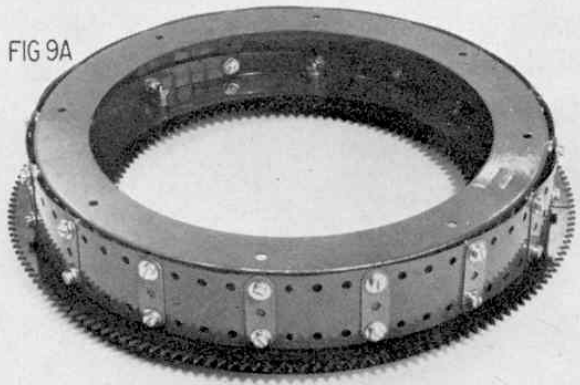

FIG 9A



Above: A roller race carrying 32 $\frac{1}{2}$ in. "rollers" and a complete ring of Large-Toothed Quadrants. No Nuts and Bolts are required for the roller ring. Below: An underside view of the roller race appearing in Fig. 9 showing how the ring of Quadrants is sandwiched between the top pair of Flanged Rings and accurately located by Pivot Bolts spaced with Washers.

Curved Strips bolted at their joins to $1\frac{1}{2}$ in. \times $\frac{1}{2}$ in. Double Angle Strips. These in turn are bolted to the inner ring which is a $7\frac{1}{2}$ in. Circular Strip. Each Double Angle Strip carries a 2 in. Axle Rod held in place by Spring Clips to provide spindles for eight of the 16 'rollers'. Interwoven between each pair of fixed rollers is a 'floating' roller mounted in a Rod Socket attached to a Formed Slotted Strip held in Place by a $\frac{1}{2}$ in. Reversed Angle Bracket which simply clips over the Circular Strip, but allows the $1\frac{1}{2}$ in. Axle Rod to move up and down to allow for any unevenness in the rim of the Flanged Ring.

The choice of $\frac{1}{2}$ in. Fixed Pulleys has three advantages. First of all, they prevent unsightly spacing of the roller rings. The bosses (though completely free to revolve and not secured in any way) give lateral stability to the 'rollers' and prevent any wobble, and, finally, the whole roller bearing is once again completely self-centring with all the advantages of plenty of central space to bring up wiring or other mechanisms to the superstructure. This bearing is very simple to build and works beautifully with a heavy block-setting crane. The more weight on this turntable, the better are its self-centring properties. Slewing is carried out by the simple expedient of a 1 in. Pulley fitted with a Rubber Ring which bears against the lower roller ring from the outside and is driven from a mechanism in the superstructure.

Finally, Figs. 9, 9a, 10 and 10a show a further develop-

ment of the same roller bearing for the advanced constructor. Fig. 9 shows the 32 rollers employed and the way in which they are mounted. All of them are carried in Slide Pieces, Part No. 50 which does the dual job of holding the 1 in. Axle Rods forming spindles for the rollers and also of securing the lapped ends of the eight $5\frac{1}{2}$ in. Perforated Strips which form the external roller ring. Each pair of $5\frac{1}{2}$ in. Strips are lapped over three holes and locked simply by the jaws of the two Slide Pieces in that vicinity. The first and last $5\frac{1}{2}$ in. Strips are tucked back into their own 'tails', the two final Slide Pieces having been slipped on previously.

Fig. 9a shows how the new Large-Toothed Quadrants are sandwiched between the two top $9\frac{1}{2}$ in. Flanged Rings and located by Pivot Bolts spaced underneath with Collars. The upper 'deck' of the turntable is shown from below in Fig. 10a where it is seen to be perfectly symmetrical and is suitable for either of the last two turntables described. Fig. 10 shows the completed heavy-duty turntable fitted with an outrigger girder frame which carries the new 167c Pinion to mesh with the complete circle of Large Toothed Quadrants. Hook rollers may be mounted on this outrigger to engage below the toothed rack. With the Power Unit mounted as shown, set in the lowest ratio, one further stage of reduction via Bevel Gears, Part Nos. 30a and 30c, a nice scale speed of rotation is achieved with 6 volts which gives adequate power for a heavy crane. The Slide Piece method of construction is quite suitable for a lesser number of rollers or for internal mounting.

FIG 10

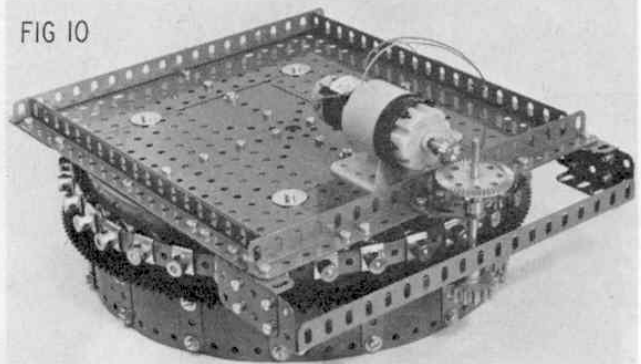
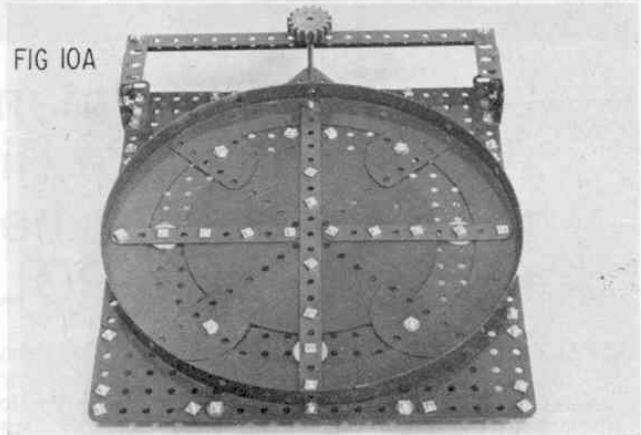

FIG 10A



Above: A heavy-duty crane turntable for the advanced modeller employing the latest Meccano components. Powerful slewing at scale speed is achieved with only six volts fed to the power unit. Below: The upper "deck" of the turntable suitable for either of the large turntables described in the text.

MECCANO CONSTRUCTORS

GUIDE by B. N. Love

PART 6: MOVEMENT ON RAILS

Engineers are frequently concerned with the question of moving equipment over rails and the rail systems used may be considered either as permanent or temporary roadways of a special kind. Readers are familiar with the 'permanent way' consisting of thousands of miles of railway lines all over the country, but other permanent rail systems are to be found elsewhere—principally in dockyards, where giant cranes move from one end of the dockyard to the other on very strong rails which are usually permanently set in concrete. Tram tracks, unlike the railways, have to be sunk

below road level, where normal traffic is flowing, so the rail section has to be grooved rather than flat topped or "bullnosed" as permanent railway track usually is. In the same way, if it is necessary to have movement of other vehicles in a dockyard, sunken rails for the cranes are again essential and the type of wheel for the different tracks has to be designed for the purpose.

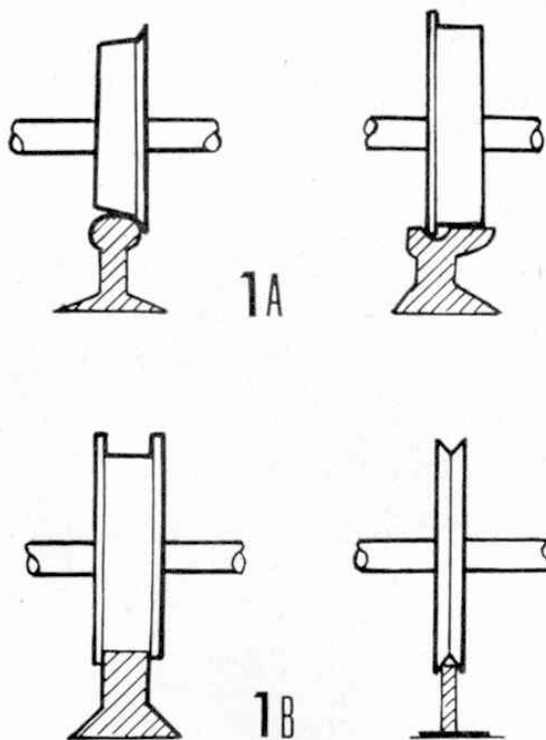

Fig. 1 (a): Diagram showing a section through two types of rail frequently used in transportation. At left is the common railway line, its appropriate wheel having a tapered-face "tyre" which centralises the wagon shafts between rails and allows for different rail radii when "banking" on a curve. At right is a typical tramway rail section, but a bevelled face wheel is often required where sharp radii curves are met with. Fig. 1 (b): Two further rail sections. The rail, left, has an almost square top, the double flange of the wheel maintaining its location. The simple rail, right, is useful in simple models and for some internal running gear in larger models.

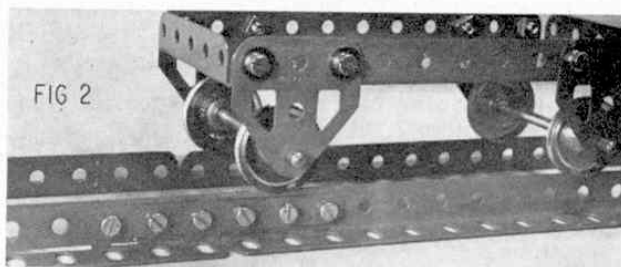

Fig. 2: A simple method of making a non-bulge joint in strip rails for pulley wheel running gear.

The Meccano system lends itself very well to the building of models which run on tracks and its wide range of wheels and wheel discs gives tremendous scope to the modeller. Fig. 1(a) shows, basically, the two types of rail section found in engineering practice, while Fig. 1(b) shows two further types suitable for models as well as some aspects of other machinery. All four types are readily made with Meccano parts and the simple rail, illustrated in Fig. 1(b) can be made from Perforated Strips mounted on edge, or from Angle Girders, as shown in Fig. 2.

The equally-simple rail truck in Fig. 2 runs very well on the track shown, so long as continuity of rail joint can be maintained. This can prove difficult when using pulleys as rail wheels but the solution is shown in the illustration. A non-bulging rail joint is achieved by butting the two ends of the strips or Girders forming the rail and overlaying the joint on each side with electrical 2 in. Brass Strips, Part No. 530 and then adding two Narrow Strips, Part No. 235a, as reinforcement. When bolted up tightly, the joint is very strong and pulley wheels will run over it quite smoothly. Note the "bump" spot on the far side caused by the curved ends of the Girders.

There are occasions when the engineer is faced with having a very heavy machine, like a Dragline, working on a soil face or even sand. In such cases, the terrain has to be levelled as far as possible and temporary tracks laid out. Care will be taken to maintain uni-

formity, but means is provided in heavy machines to compensate for vertical movement of temporary tracks on soft or shifting ground. Fig. 3 shows two views of a Dragline bogey, which would be one of four, mounted at each corner of a dragline. This would distribute the weight over a total of 16 wheels and the bogies would run on two sets of twin tracks, one length of which is shown in Fig. 3. This particular design of bogey truck utilises the double flanged wheels and flat-topped rail shown in Fig. 1(b), normal Meccano $1\frac{1}{8}$ in. Flanged Wheels being used and fitted with 6 or 8-hole Wheel Discs on one side of the bogey and 50-teeth Gear Wheels on the other. The flat topped rail is made from three thicknesses of Perforated Strips sandwiched between Angle Girders.

If such a track is used for a model dragline, the twin rails should be spaced accurately by the use of Perforated Strips and then cross-connected to the other twin rails at the other side of the model to suit its width. Spacing strips can be avoided if the whole set of rails is screwed to a base-board.

It will be noticed from the illustration that the bogey truck has a Handrail Support, Part No. 136, screwed into the top of a Channel Bearing, to which double thicknesses of $2\frac{1}{2}$ in. Flat Girders are attached with Nuts and Bolts, reinforced with Washers for a secure grip. The Flat Girders give adequate strength and serve as bearings for the Axle Rods carrying the double-sided flanged wheels, while the Handrail Support acts as part of a "Ball and Socket" joint.

Since the temporary rails over which a heavy dragline would work are subject to displacement, the bogey trucks must be able to "ride" up and down a little, the two rear ones being mounted at either end of a heavy compensating beam, pivoted at its centre to the rear of the dragline platform. The beam and the forward part of the superstructure would carry four Socket Couplings, Part No. 171, pointing downwards to take the heads of the Handrail Supports. A short length of Spring Cord, Part No. 58, gripped in the cross bore of the Handrail Support by double Grub Screws, will also pass into the tapped holes at the bottom of the Socket Coupling. This will give a flexible joint which can stand considerable downward pressure but will not fall apart if the model is lifted bodily. The Socket Couplings would, of course, have to be securely attached to the superstructure of the dragline.

Fig. 3a shows the under view of the bogey trucks, where the Sprocket Chain drive and 25-teeth reduction Pinion can clearly be seen. In operation, the chain lies in a slightly sagging loop to accommodate any

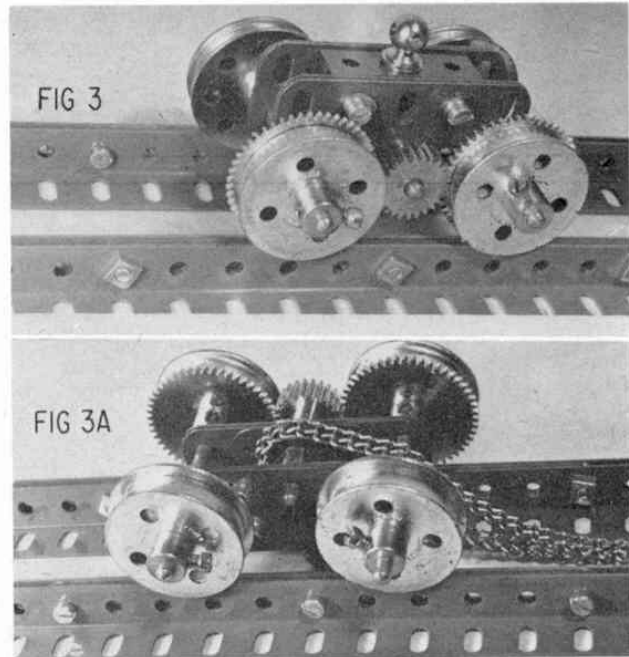

Fig. 3: Dragline bogey truck with double flanged wheels and flat-topped rail. Handrail Support at top forms lower part of "Ball and Socket" joint with Socket Couplings attached to superstructure.

Fig. 3 (a): Lower view of dragline bogey showing spur gear drive to travelling wheels via Sprocket Chain. Chain drive runs in a slack loop at low speed and accommodates rise and fall of bogey over uneven rail sections.

rise or fall in the bogey trucks, this being as acceptable as in the prototype because of the slow speed of operation of such gear.

For the locomotive building enthusiast, Meccano Flanged Wheels provide a ready-made item for track working and Fig. 10 shows how they are put to good use in the construction of a self-contained locomotive bogey. The perforations in the Flanged Wheels take standard Meccano Bolts or Pivot Bolts so that connecting rods, made from $2\frac{1}{2}$ in. Narrow Strips, can be attached as shown. Cylinders are provided by Couplings, Part No. 63, housed in a pair of Chimney Adaptors on either side of the truck and a drive is imparted to the wheels via 1 in. Gear Wheels meshed

Fig. 4: Travelling arrangements, for the advanced modeller, having a number of advantages over simpler designs. Note Worm drive and compact positive drive to all axles.

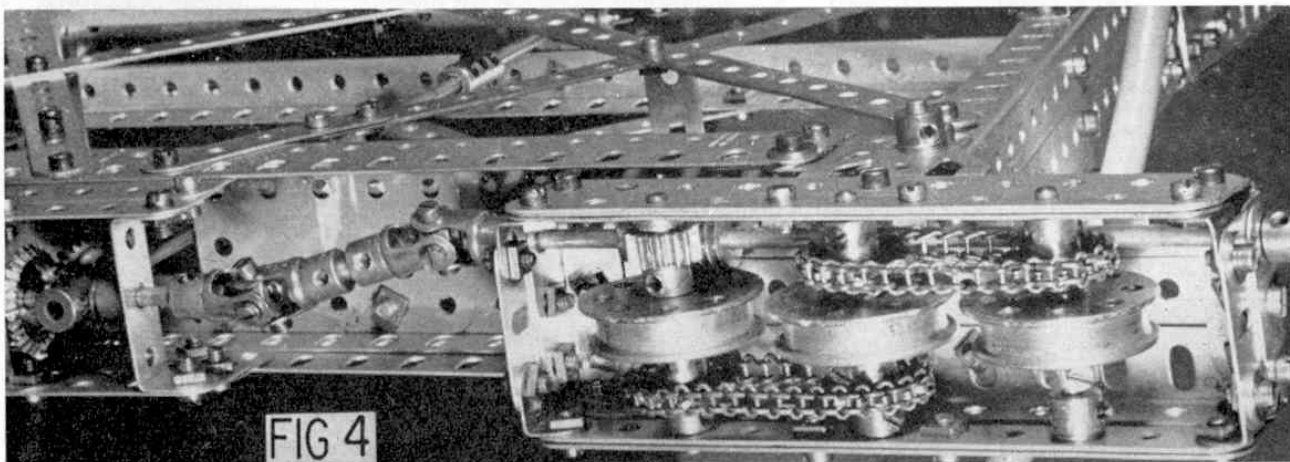

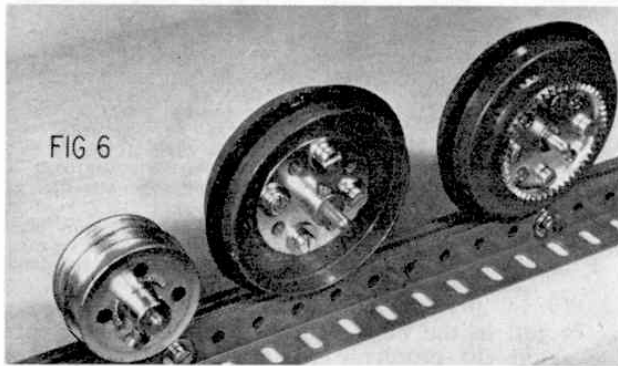
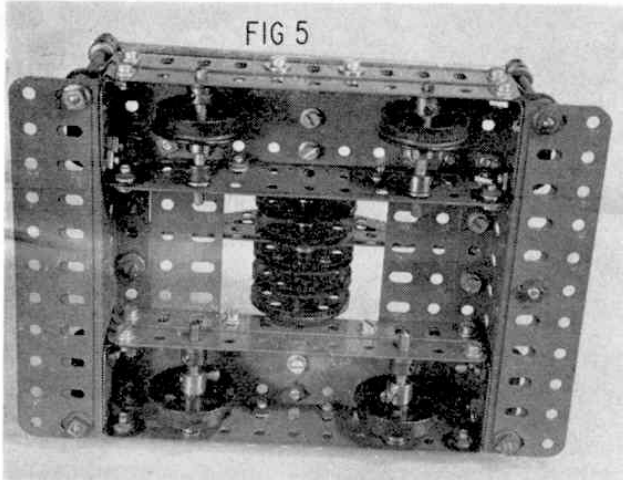

Fig. 5: Heavy duty "crab" trolley for giant Block-Setting Crane making use of independently-mounted Flanged Wheels for maximum axle strength.

Fig. 6: Built-up travelling wheels with centre flange and wide surface contact suitable for heavy machinery. Note recess in centre of flat-topped rail. The extra thickness of strips is divided in the centre and spaced by a Washer, nut or twist of Meccano Cord to accommodate depth of centre flange.

together, the centre shaft receiving its drive via a $\frac{3}{4}$ in. Pinion and Contrate Wheel. The shaft carrying the $\frac{3}{4}$ in. Pinion also forms the pivot for the bogey truck when it passes up through the boiler platform of the locomotive. Although the front axle carries a Coupling, this is simply to join two short axles, to make use of available parts at the time of building, but a $2\frac{1}{2}$ in. Axle Rod may be used instead.

A further application of the standard Flanged Wheel is shown in Fig. 5 which illustrates a heavy duty "crab" truck used on a model of a Giant Block-Setting Crane. As this crab takes a considerable load of genuine stone, it is built to rugged proportions with adequate strengthening from Flat and Angle Girders. All four rail wheels are mounted on independent short axles to relieve bending strains and to keep the centre section of the crab clear for the fall of the hoisting ropes. This is a case where the engineer is concerned with internal rail running which is a feature of many items in the engineering field. The crab illustrated runs on a set of rails mounted rigidly to the boom of a crane, but in many other machines—particularly interesting textile machines—integral portions of the machinery oscillate on rails, sometimes over considerable distances, and quite often the running wheels are of simple grooved or pulley form.

As machinery gets heavier, to handle greater loads, the wheels on which such machines are carried must be proportionately increased in size and strength. A Gantry crane capable of straddling 200,000 ton oil tankers in shipyards has now been installed in a British shipyard and, as might be expected, its travelling wheels run on flush or sunken rails and make use of centre flanged wheels which present a wide surface to the rail contact point. Samples of such wheels are illustrated in Fig. 6 where three types are shown. The smaller compound wheel is made from two $1\frac{1}{8}$ in. Flanged Wheels sandwiching a 6-hole or 8-hole Wheel Disc between them. The two larger

Fig. 7: Heavy-duty travelling gear employing wide-face centre-flange wheels. Note unorthodox use of small Helical Gears meshing with large Contrate Wheels to give a smooth and compact gear drive.

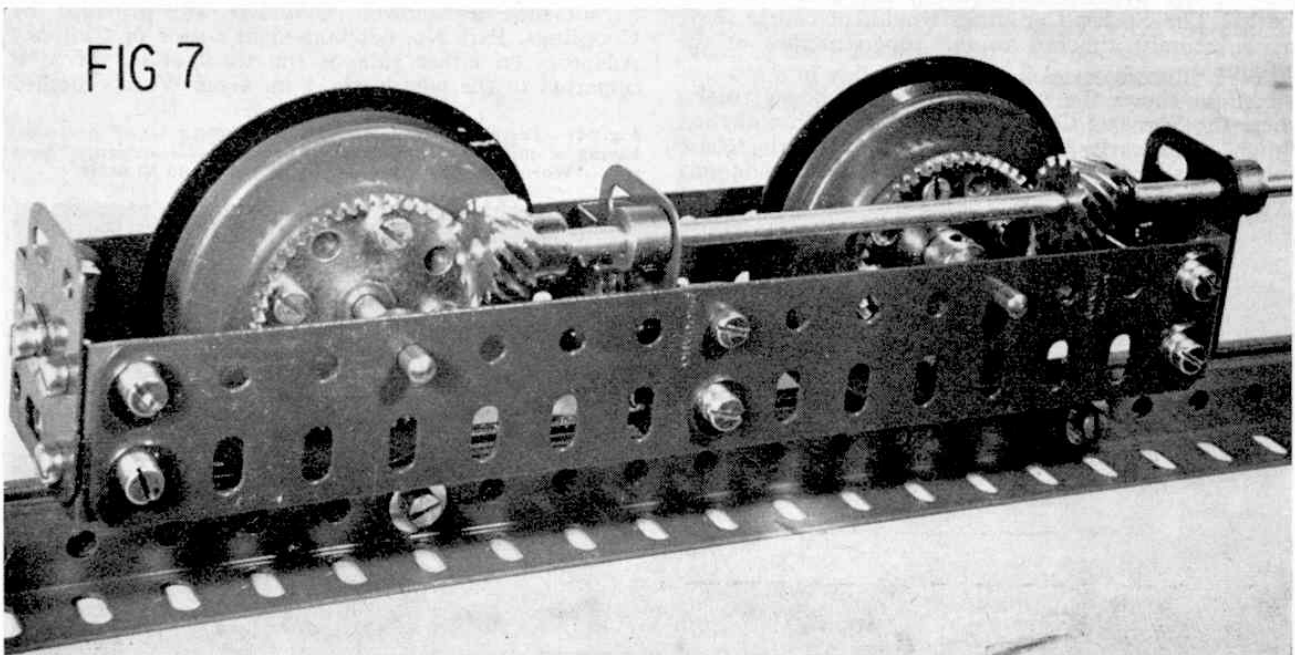

wheels are made from Wheel Flanges bolted to a Face Plate and the illustration shows how they may be constructed with shallow or wide hubs. The shallow version, in which the flanges are mounted rim outwards, gives a centre flanged wheel of minimum width, but when the flanges are mounted on the Face Plate with rim inwards, a more stable wheel is produced and a large Contrate wheel can then be bolted directly into the assembly, forming an extra boss with that of the Face Plate for additional rigidity with very little overhang from the Contrate. Being mounted integrally with the wheel, the Contrate gives an absolute positive drive. By using Bush Wheels or Wheel Discs bolted to the Wheel Flanges, additional hub support can be achieved. For the narrower of the two centre flange wheels illustrated, standard length Bolts are adequate but $\frac{3}{4}$ in. Bolts are required for the broader version where they secure the Contrate Wheel, two Wheel Flanges and the Face Plate in one go.

When applying a geared drive to travelling wheels, some thought should be given to proportionate sizes of the gears employed. In the case of the large centre-flange wheels mentioned, the Contrate Wheel shown is nicely scaled and can be driven by $\frac{1}{2}$ in. or $\frac{3}{4}$ in. Pinions. In this case, additional width of the truck carrying the wheels must be provided. An elegant solution to the problem of keeping down overall width of the wheel trucks (an important consideration in a crowded dockyard) is supplied by the use of gears which can run at right-angles to the wheel axles and over the top of them. This is achieved, as shown in Fig. 7, by the unorthodox use of the small Helical Gear which will mesh perfectly with the large Contrate Wheel at the "2 o'clock" position. Adjustment and careful packing with Washers to find the correct meshing point is essential, but once found, the drive is very smooth and quiet.

The use of the large travelling wheels outlined requires a structure of proportionate dimensions and so the use of the standard Flanged Wheels is far more popular for the smaller or medium-sized models. Fig. 8 shows a typical travelling bogey truck, suitable for a dockside crane, where linkage between travelling wheels is by Sprocket Chain drive, this being quite adequate. Again, Flat Girders provide adequate wall strength and the double thickness of $2\frac{1}{2}$ in. Triangular Plates provide both heavy journals for the central driven axle an strong trunnion supports for attachment of the bogey truck to the crane tower. In this case, the small Contrate drive, which gives pleasing proportions, is mounted externally on the truck.

In Fig. 9, the truck is shown mounted at the foot of one of the crane portals, and it will be noted that the triangular supports pivot in a parallel bearing. This gives alignment in the forward direction but allows the bogey some "float" to negotiate uneven levels on the dockside rails. If such a crane were required to move on a curved path of wide radius round a dock-yard basin, a universal pivot would be required to allow the bogies to "steer", i.e. be steered by the rails over which they would run. The $1\frac{1}{2} \times \frac{1}{2}$ in. Double Angle Strip carrying the small contrate spindle provides an adequate bearing when packed out by Washers and bolted tightly to the truck wall. The Universal Couplings leading off from it may then be connected to a suitable power take-off point by appropriate shafting and gearing.

Fig. 4 shows a very neat arrangement of bogey truck for the advanced modeller, based on sound engineering principles. With four similar bogies a crane or other heavy machine would receive a twelve-

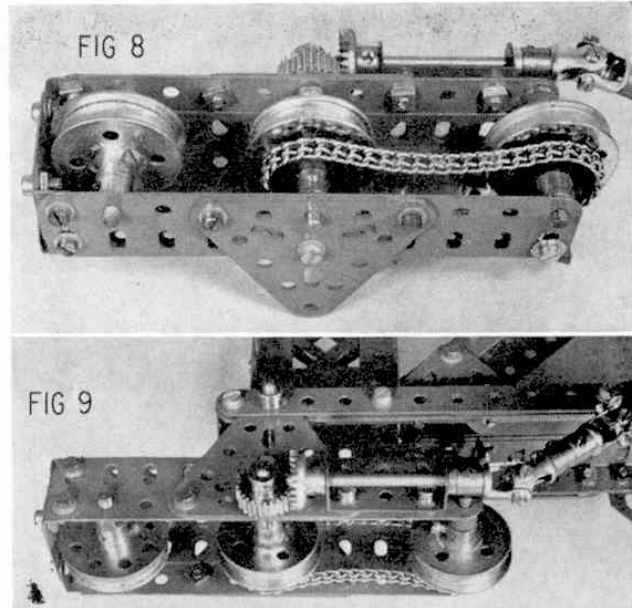
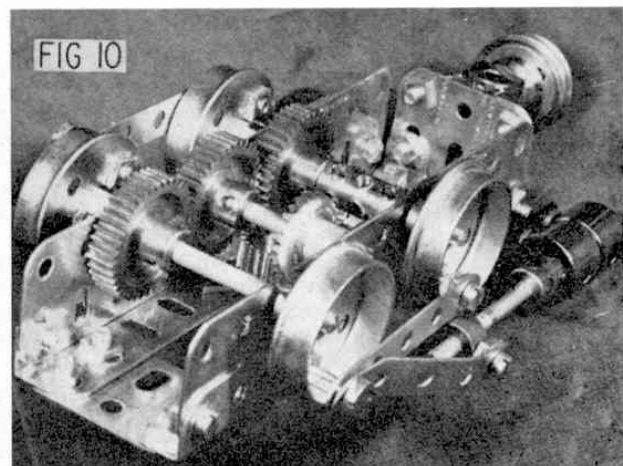
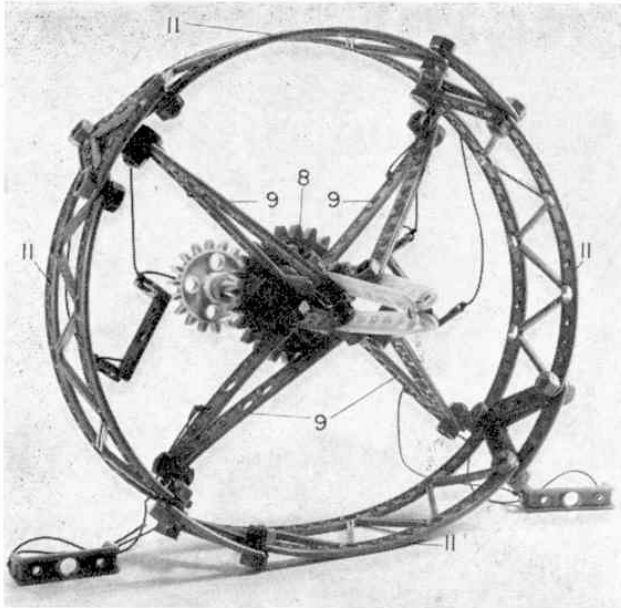

Fig. 8: Simple powered bogey truck for dockside crane. Note strong trunnion arrangement of Triangular Plates to give adequate vertical support for pivoting arrangements.
Fig. 9: Drive arrangements for simple powered bogey. Universal Couplings to Contrate drive should be maintained at a shallow angle for efficient drive.

wheel drive since every load-carrying axle is directly driven. A Worm and Pinion drive to the trailing axle in each bogey maintains the overall slimline appearance of construction without sacrificing efficient wheel drive at scale speed. Additional bearing surfaces for each axle are provided by Perforated Strips, bolted to the Flat Girders at each side of the bogey trucks, while the careful use of paired Universal Couplings enables the central vertical drive from the crane portal to be transmitted to the off-centre Worm drive shaft. A further advantage of this drive system is that the Worm shafts in each set of bogies on one side of the model rotate in the same direction, so that no split reversing gears are required from the drive shaft in the portals. It is true that, as a result, the model is "locked" when drive to the wheels is switched off, due to the "non-reverse" configuration of Meccano Worm drives, but this is of no disadvantage in the working model.

Fig. 10: Typical use of standard Meccano Flanged Wheels in construction of powered bogey for model locomotive.





The revolving top section of the model as it appears removed from the tower structure.

PARTS REQUIRED

- | | |
|------------------------|-----------------------------|
| 12—2-hole Strips | 1—Axle Clip |
| 6—3-hole Strips | 3—6" Axles |
| 6—5-hole Strips | 4—2-hole Triangular Girders |
| 4—Bases | 1—Handle |
| 56—Bolts | 1—24-teeth Gear Wheel |
| 2—1" Bolts | 1—18-teeth Gear Wheel |
| 51—Nuts | 1—12-teeth Gear Wheel |
| 9—Angle Brackets | 1—20-teeth Sprocket Wheel |
| 11—Double Angle Strips | 1—10-teeth Sprocket Wheel |
| 2—Road Wheels | 4—Bridge Girders |
| 1—Pulley Wheel | 4—3-hole Triangular Girders |

MECCANO CONSTRUCTORS GUIDE by B. N. Love

PART 7 : CRAWLER TRACKS

MACHINERY WHICH TRAVELS on self-laying tracks fall into three basic categories and it is important to understand the different requirements of each. They may be listed as follows :

1. Excavators and Mobile Cranes with heavy-duty turntables.
2. Bulldozers and Crawler Tractors.
3. Military Track-laying Vehicles.

In the case of Category 1, the requirements are for simple, but rugged tracks which will provide a firm support for a heavy superstructure and allow it to run steadily but slowly across the site where it is working. Fig. 1a gives the basic pattern for such heavy-duty tracks which are made of thick steel plates hinged at their edges with two or more lugs built into the track shoes themselves. The contact surfaces are quite flat with a small recess moulded into them which assists the tracks in bedding down where the excavator is used in a stationary position. This type of track is mounted on a frame of rollers which is rigidly attached to either side of the superstructure or turntable, giving a stable platform, and the driver will often use his machine to skim a flat surface on the site if a bulldozer is not available to do this.

Tracks required for Category 2 are generally much lighter in design but are nevertheless strongly made to withstand the stresses of the workload on bulldozers and crawler tractors. Essentially, these machines must be capable of pulling, pushing and winching very

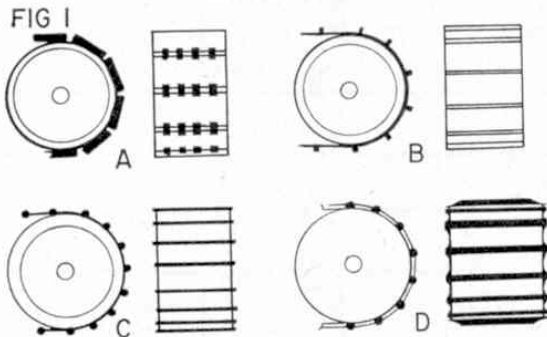

Fig. 1a. The heavy-plate slow-moving track used on Excavators, and, Fig. 1b, the lighter, but powerful-grip track form of the Bulldozer or Crawler Tractor. Fig. 1c. Highly-flexible track for high-speed Tanks and some small Tractors or "Calfdozers" and, Fig. 1d, tracks for medium and heavy Tanks. Note convex shoe form to reduce "scrubbing" when steering.

heavy loads and their tracks must be designed accordingly. This means that the track must be flexible enough to conform to the contours of rough ground over which the crawler may be working, yet light enough not to absorb excessive power. At the same time they must be capable of a positive grip on the site surface and are therefore fitted with "spuds" or ridges, as shown in Fig. 1b, which bite into the ground. Generally speaking, crawler tracks are capable of working at higher speeds than those in Category 1.

Moving on to Category 3, i.e. Military Vehicles, track requirements are different again. In some cases, high speed over rough terrain is the required performance for infantry carriers and light tanks. It is therefore necessary to fit highly flexible track with short length "shoes", or track elements, and suspension is vital to cope with sudden changes in ground contours. Bulldozers negotiate rough ground by having their track frames independently mounted, but linked one to the other with compensating beams or cranks. Thus

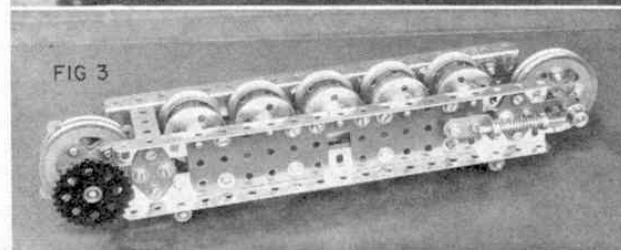
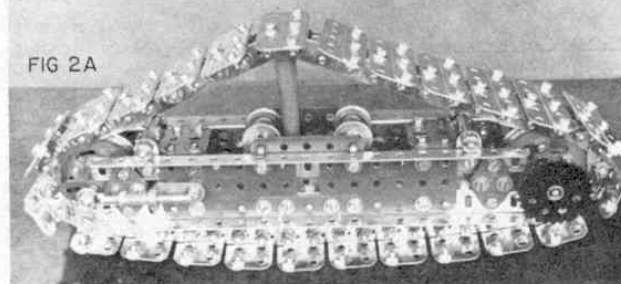
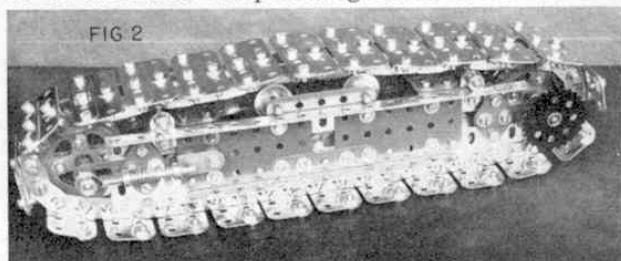

Fig. 2. View of a complete track assembly for a small-scale Excavator. Note the spring slide compensator for track tension. Fig. 2a. This illustration gives a good idea of the excellent scope available from the track-tensioning device described in the text. Fig. 3. A track frame construction for a small-scale Excavator showing under view of load-carrying rollers.

a rise of one track frame causes a fall of the other so that the tractor keeps on a reasonably even "keel" to prevent dangerous tilting. Tanks on the other hand have track drives mounted solidly on the hull and the travelling gear is mounted on multiple sprung units. While such vehicles can double up as towing tractors they are, essentially, high or medium-speed gun platforms. Fig. 1c shows the general form for high-speed tank tracks while that of Fig. 1d is typical of medium or heavy tank tracks. The track "shoes" of some tanks, including the British Chieftain, are shod with rubber blocks to reduce road and track wear.

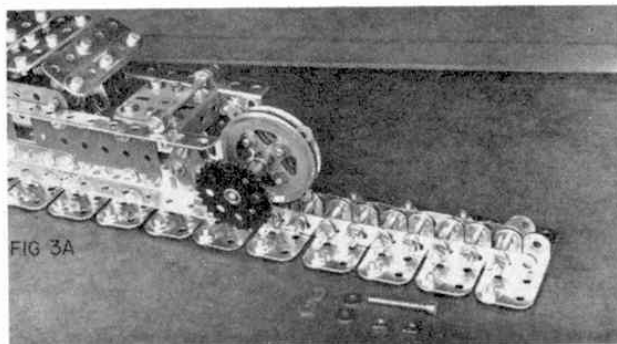

Fig. 3a. Driving sprocket arrangements and general view of a track construction using Fishplates and Double Brackets as track plate hinge components.

Meccano modellers obtain great pleasure from making track-laying vehicles and some ingenious efforts have appeared in the Meccano Magazine from time to time where Sprocket Chain, Rubber Driving Bands, paper clips and Meccano Cord have all been pressed into service for elementary models. The system does, however, lend itself to the construction of authentic tracks falling into some of the above categories. Fig. 2 shows what can be done in the way of making a small-scale excavator track assembly of realistic appearance and performance. It is strongly constructed with a compound girder frame carrying both lower and upper rollers and the journals for the track sprocket and idler wheel, with its tensioning device. This last is provided by spring-loaded Rod and Strip Connectors applying tension via the slots in 2 in. Slotted Strips, as shown, and Fig. 2a shows the remarkable degree of adjustment available with this arrangement.

Fig. 3 shows an inverted view of the track frames displaying the bottom rollers on which the entire weight of the model is carried—an important aspect of the prototype as superstructure weight should always be relieved from the driving or idler wheels which are raised clear of the ground. This can be seen quite clearly in Fig. 2. Fig. 3a, showing a portion of the track laid out, clearly shows the constructional system used. Each track plate is made from a 2½ in. Flat Girder, overlaid with a 2½ in. Perforated Strip for appearance sake to hide the slotted holes, while a centre Bolt fitted with a Washer maintains the level of the plate in the second row of holes. Hinge elements are made from pairs of Double Brackets, bolted directly to the track shoes and reinforced with Fishplates, a further pair of Fishplates linking the shoes together, with long Bolts fitted with a pair of lock-nuts being used as hinge pins. One-inch Axle Rods may also be used as track pins, secured with Spring Clips, Collars or Cord Anchoring Springs.

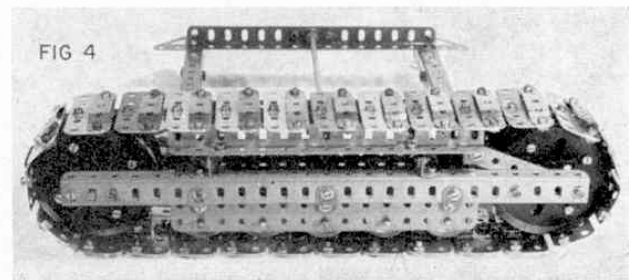

Fig. 4. General view of a track assembly for heavy-duty Excavators.

The dogs on the driving sprocket are $2\frac{1}{2}$ in. Narrow Strips bolted between a pair of 2 in. Pulleys and suitably spaced with Washers. The $1\frac{1}{2}$ in. Sprocket Wheel mounted on the same rod receives a chain drive from the side of the excavator.

Passing to a more sophisticated track form, Fig. 4 shows a track assembly suitable for a larger model. Experienced constructors will raise an eyebrow at the peculiar shape of the $2\frac{1}{2}$ in. Perforated Strips which appear in the photograph as they are bent deliberately to the form shown. The close-up of Fig. 4a shows the shape more clearly and at this stage the reader is warned that there is no intention of pursuing a policy of mutilation in the course of the Meccano Constructors' Guide. However, probably the most common part in the system is the $2\frac{1}{2}$ in. Perforated Strip which has been turned out by the million at Liverpool over the last half-century. Literally thousands of them linger at the bottom of store boxes where they have been relegated as "tatty" or slightly bent parts devoid of most of their paintwork. Now is the chance for all ambitious constructors to put their old stock to good use! Crawler tracks, etc. never have painted surfaces for obvious reasons and they are soon scrubbed to bright steel by a run across the site where they are employed. Readers can give their surplus or redundant $2\frac{1}{2}$ in. Strips similar treatment by dunking them in paint stripper (reading the instructions thereon very carefully!) and finishing off the stripped parts with an emery cloth rub. The fact that the finished Strips will be bare, scratched and well worn will simply add to their appearance in the right place.

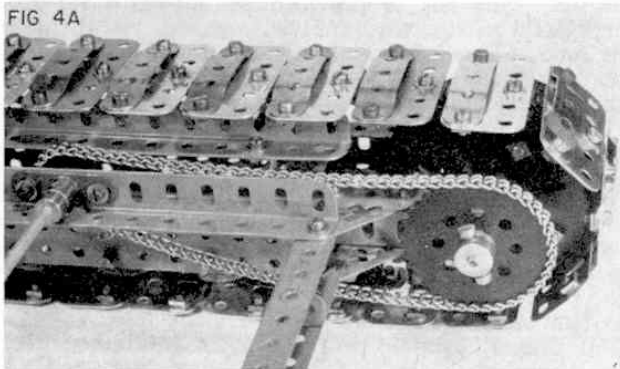

Fig. 4a. The sprocket chain drive and general track arrangement of the assembly shown in Fig. 4.

The problem of getting the correct shape to these Strips is solved by making a tool from parts inside the system. Fig. 5 shows a little hand-screw Press which does the job quickly, neatly and with constant regularity, the "exploded" view in Fig. 5a showing the component parts of the Press. The bed is a $5\frac{1}{2} \times 2\frac{1}{2}$ in. Flanged Plate on which from four to six $5\frac{1}{2}$ in. Flat Girders are trapped by a locking plate, as shown. The screwing and guide posts are mounted on a $2\frac{1}{2} \times 2\frac{1}{2}$ in. Flat Plate which is inserted from below so that the Pins and Bolt shanks protrude up through the Flanged Plate. These pins form a register for the strip-forming jaw which is made from two 3 in. Angle Girders rigidly spaced by a 2 in. Screwed Rod packed with Washers. The guide post plate remains in position under the Flanged Plate because the serrations of the Bolt threads bind slightly against the edges of the holes in the Flanged Plate.

Fig. 5 shows a $2\frac{1}{2}$ in. Strip inserted in the Press ready for forming. The butterfly screws are made from Threaded Couplings fitted with 2 in. Axle Rods

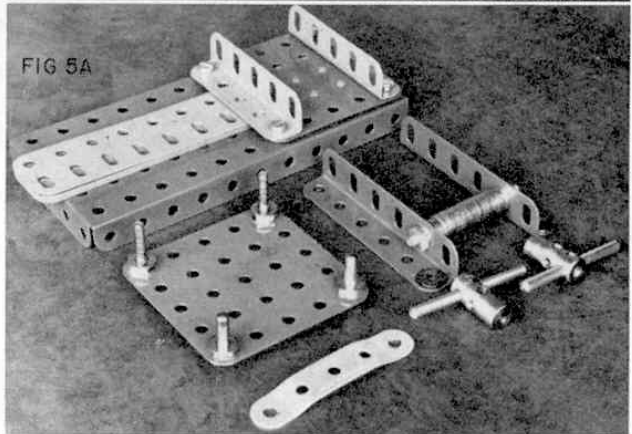
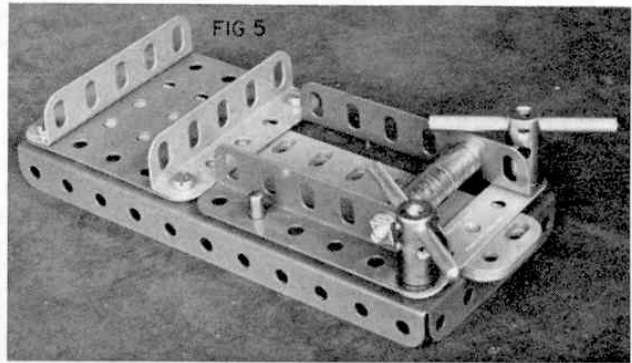
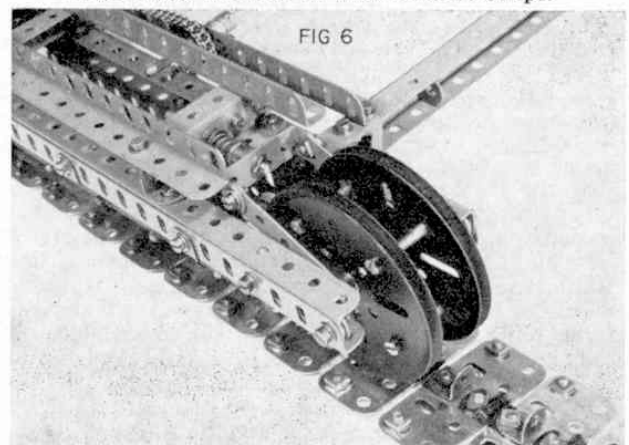

Fig. 5. A useful pre-forming Jig for scrap Meccano Strips used for smooth-faced track segments. Note the $2\frac{1}{2}$ in. Strip in the jaws ready for bending. Fig. 5a. The pre-forming Jig with the locating plate and pressure jaw removed. Note the formed Strip in the foreground.

for leverage. Pressure should be applied equally at the same time until the butterfly screws are tightened right down. The object is to produce a bridge shape in the $2\frac{1}{2}$ in. Strip with sufficient clearance below its arch for a bolthead. It may be necessary to adjust the number of Flat Girders laid on the bedplate to get the clearance required. The forming process does, of course, shorten the overall length of the $2\frac{1}{2}$ in. Strip, but not so much as to prevent it being located at standard spacing with Meccano Nuts and Bolts.

Referring back to the track plates shown in Fig. 4a, it will be seen that the bridge-formed $2\frac{1}{2}$ in. Strip gives a smooth contact surface to each "shoe" so that

Fig. 6. Top view of Excavator track frame showing idler wheels, tension ram and centre-hinged formation of track segments. The journals for the idler wheels are carried in Slide Pieces mounted on internal 2 in. Strips.



no scuffing of boltheads occur and thus the tracks steer with great smoothness. The same illustration shows the chain drive to the excavator tracks taken from the turntable framework. Flat Plate tracks can be made from other lengths of Flat Girders of Flat Plates, hinged at their extremities with Meccano Hinges, Part No. 114. However, the track assembly shown in Fig. 4 has 27 track plates on one track frame. This means a total of 54 track segments for both sides of the model and, if double hinges were used, some 108 Hinges would be required—a prohibitive cost for most modellers. As an alternative, therefore, the centre-hinge track section shown in Fig. 6 is perfectly satisfactory and construction is very straightforward, as can be seen. The idler wheels shown are pairs of 3 in. Pulleys spaced by long Bolts and fitted with a tension yoke made from a pair of 3 in. Strips bolted to a $1\frac{1}{2} \times \frac{1}{2}$ in. Double Angle Strip fitted with a Rod Connector and Compression Spring. The Axle Rod carrying the idler wheels runs in bearings made from Slide Pieces running inside the channel girders on 2 in. Perforated Strips attached to the channel girders with Bolts and Washers. Fig. 6a shows the under view of the track frame with bottom rollers displayed. One-inch Pulleys with Rubber Rings are used for a cush-

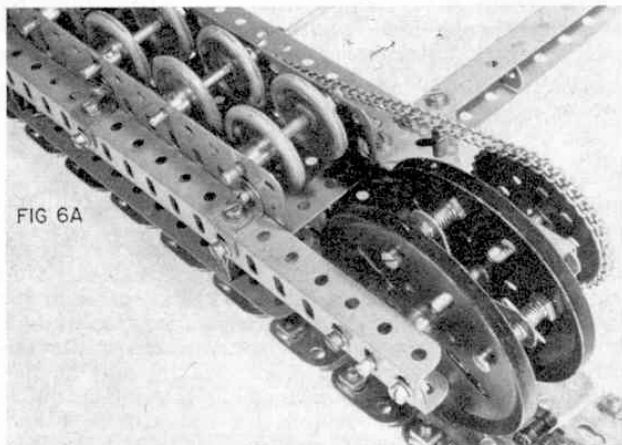

Fig. 6a. An underside view of the heavy-duty track frame showing support rollers and drive sprocket containing $2\frac{1}{2}$ in. Strips used as driving "dogs."

ioned and quiet motion and, again, these are set to keep the driving and idler sprockets clear of the ground. $2\frac{1}{2}$ in. Perforated Strips are set at 90° between the 3 in. Pulleys on the driving sprocket to engage with the elongated slot of the $\frac{1}{2}$ in. Angle Brackets attached to each track plate hinge.

With the exception of half-tracked vehicles, track-laying motions are always steered by locking one of the tracks and maintaining drive to the other. This means that one track is skidding or "scrubbing" as the vehicle turns. Tanks and crawler tractors need to be far more manoeuvrable than excavators and their axle boxes must be designed to transmit the necessary power both for traction and steering. Fig. 7 illustrates an excellent design of axle reduction box suitable for transmitting a very powerful drive to a Meccano Crawler Tractor. The final Axle Rod is a "dead" axle, i.e. it does not revolve, and is supported externally by the outrigger bearing shown alongside. The drive to the large track sprocket shown is directly via Pinions and Gear wheels in a reduction arrangement.

Finally, an "economy" track is featured in Fig. 8 for the benefit of readers who have a limited supply of components. The track shoes have already been

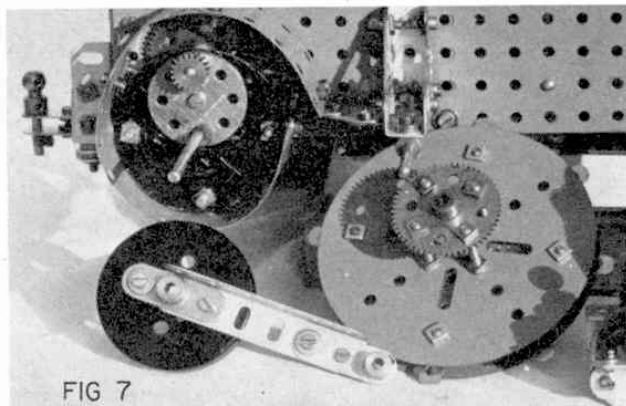

Fig. 7. Heavy-duty reduction gear in a rear axle assembly for a Crawler Tractor. Note the outrigger arm with journal for supporting the fixed sprocket shaft.

described but they are attached on this occasion to $2\frac{1}{2} \times 2\frac{1}{2}$ in. Plastic Plates. This produces a highly flexible track with the following advantages. It is very quick and simple to construct, is light in weight, flexible enough for "high-speed" models, is realistic in appearance and not bulky. By using $2\frac{1}{2} \times 2\frac{1}{2}$ in. Plastic Plates (recent production types with a hole punched in the centre), a smooth path is provided for the travelling gear rollers, as shown, and centre dogs can be bolted to the tracks at $1\frac{1}{2}$ in. spacing. These boltheads will be under the formed $2\frac{1}{2}$ in. Strips so that the finished model tank has perfectly smooth-faced tracks capable of running on domestic surfaces, without creating damage or havoc!

Fig. 8 shows only a section of "economy" track and the 2 in. Sprocket Wheels shown are included for scale appearance sake. The actual drive to the centre dogs bolted to the Plastic Plates would be via a pair of Bush Wheels mounted between the 2 in. Sprockets. These Bush Wheels would be fitted with Strips, Brackets or Bolt shanks suitably mounted to engage the Angle Bracket centre dogs. To give these Brackets additional support, each formed Strip may be reinforced by a normal $2\frac{1}{2}$ in. Strip, bolted on with it at the same time (on the outside of the Plastic Plates).

Hull details for tanks are readily modelled in Meccano parts and with the "Economy" track described quite a realistic model of the Royal Tiger or the British Chieftain is well within the scope of the Meccano system.

Fig. 8. A specimen length of "economy" tank track made from pre-formed $2\frac{1}{2}$ in. Strips mounted on Plastic Plates.

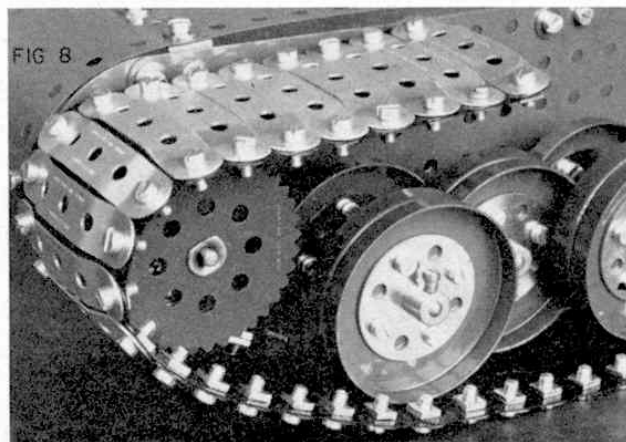

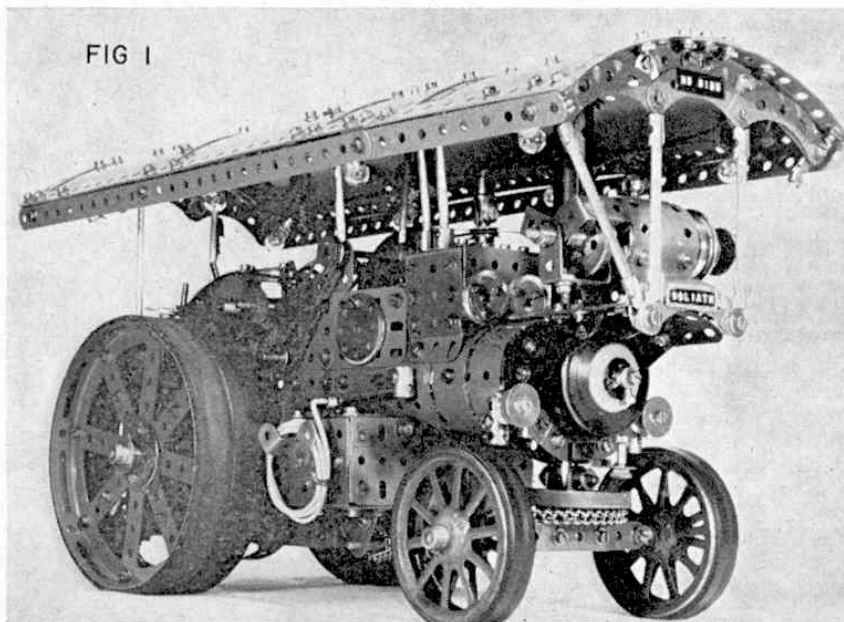

FIG 1

MECCANO CONSTRUCTORS GUIDE

by B. N. LOVE

Part 8: Traction Engine details and mechanisms

JUDGING BY THE roaring success of Traction Engine Rallies held all over the country and the high prices paid for derelict engines which are subsequently restored to their former glory with loving care by devoted enthusiasts, the popularity of these ancient juggernauts seems eternal. As a Meccano modelling subject, the Traction Engine has never really lost its

Fig. 2: Rear proportions of a Traction Engine are as important as those at the front. The slim coal compartment tow-bar and Winch Roller brackets complement the Boiler diameter, on which the scaling is based.

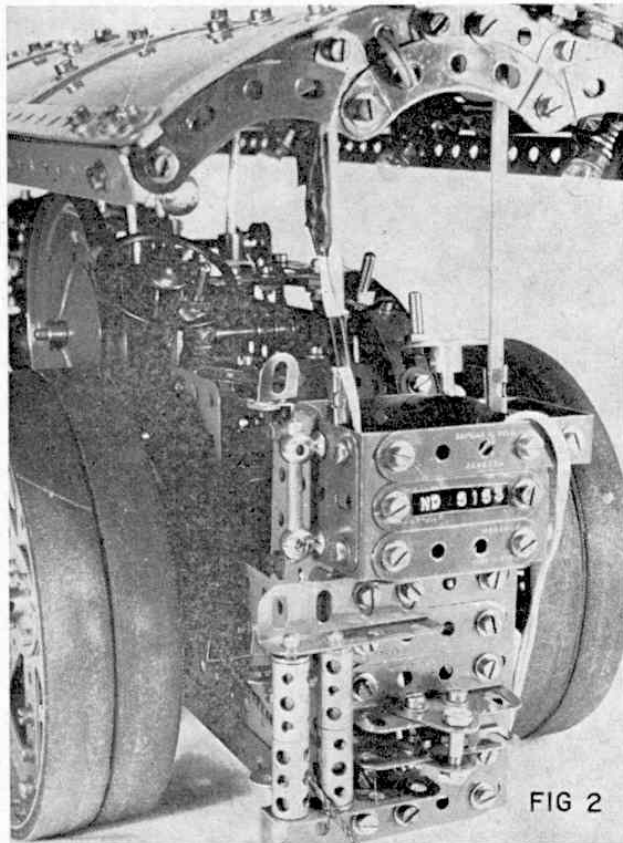

FIG 2

popularity and was familiar as a Super Model Leaflet more than forty years ago. Those readers who can go back that far in time, or who have copies of the original Leaflet, will be able to make comparisons with a very recent model shown in Fig. 1. The basic dimensions of the original model produced a pleasing scale, but there were several drawbacks in the original design. A number of experienced constructors have given a great deal of thought to the improvements required and they are featured in this part of the Guide.

The Meccano Boiler, Part No. 162, sets a suitable scale for a model, but it is important to ensure that the tail-end of the engine has the same narrow proportions if the overall width of the model is to be kept in similar proportions to the prototype. Due to the width of the early Meccano Electric Motors, the fire-box ends of traction engines tended to be far too wide, but the introduction of the slim combined motor and 6-speed gearbox units enables the constructor to improve the appearance at the rear in a striking fashion, as shown in Fig. 2. Bearing in mind that space is required for a winch drum on one side of the rear axle and a heavy differential gear on the other, the driver's compartment must be reduced to an overall width of 2 in. for good proportions.

At this stage it is probably as well to affirm that the Meccano modeller is not working in the same sphere, or with the same materials, as the scale modeller and he should certainly not attempt to follow scale in a slavish fashion—a sure road to frustration and disappointment. If an appropriate scale to the half-inch spacing of Meccano parts presents itself, so much the better, but general appearance with satisfactory proportions is a reasonable aim.

Terminology for traction engines is a study of its own, but basically there are three types, as follows:

(a) Agricultural Engines—usually fitted with all-metal wheels and tyres, “spuds” being available for fitting to perforations in the rim of the rear wheels for extra grip. These engines were commonly single-cylinder machines with no canopies and included ploughing engines and other special-purpose farming engines.

(b) Road Locomotives—usually fitted with heavy solid rubber shod wheels of broad face at the rear, and of compound (twin-cylinder) engine type. A rear canopy was fitted for the protection of the driver.

Used for heavy haulage on well-made roads and frequently fitted with two gears only, reverse being operated by steam valves.

(c) Showman's Engines—usually compound engines as in (b), but frequently fitted with an extra top gear for fast, light running. Canopy covering full length of engine, plus dynamo on extended bracket. Winching and derricking gear was normally fitted and the decoration was always very artistic and ornate.

The latter category gives, perhaps, the greatest scope to the Meccano enthusiast and Fig. 3 shows some of the extra features which can add realism to a showman's engine. The boiler is, again, Part No. 162, but in the model shown, it is clad in $2\frac{1}{2} \times 2\frac{1}{2}$ in. Flexible Plates secured by Narrow Strips which extend its length into the firebox region. The cantilever dynamo bracket is made from $2\frac{1}{2} \times 1\frac{1}{2}$ in. Triangular Plates supporting a pair of $2\frac{1}{2} \times 1\frac{1}{2}$ in. Flexible Plates which form the dynamo platform. A pair of tweezers is indispensable for boiler work as a long reach inside is required to secure the Boiler End, dynamo bracket, etc. with internal Nuts. Care and patience at this stage will, however, produce the desired effect. Fig. 3 shows a dynamo at the front driving a "field exciter" at the rear of the chimney. The exciter, in turn, feeds back a regulated current to the field coils of the main dynamo, thus reducing the size of the dynamo to manageable proportions, while enabling it to cope with a wide range of electrical loads in driving the various items of fair-ground electrical equipment. Brass Wheel Discs form the body of the field exciter, while $1\frac{1}{2}$ in. Pulleys and large Flanged Wheels form the end casings and bearings. Chimney details are achieved by Sleeve Pieces, small

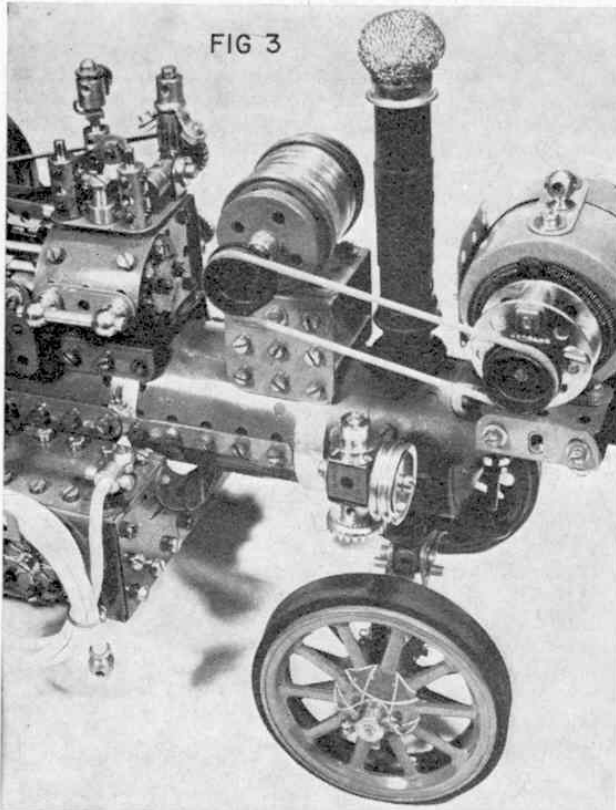

Fig. 3. Forward end of a Showman's Loco showing Cantilever Dynamo bracket protruding over the smokebox. The machine mounted behind the chimney is a "field exciter" which feeds current back to the main dynamo in the prototype. Note steam chest details, water hose, ornamental lamp, twin front wheels and chimney spark arrestor.

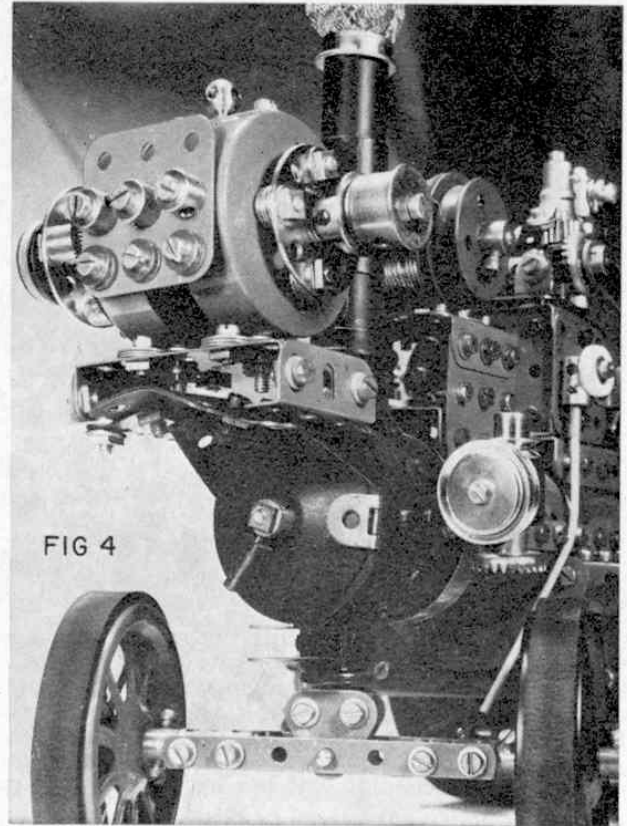

Fig. 4: General front view showing details of main dynamo, double flanged pulley wheel, smokebox door and slim, floating front axle.

Flanged Wheels, Chimney Adaptors and a $\frac{3}{4}$ in. Dinky Toy tyre which gives a smooth moulding to the boiler contour. The chimney is locked in position by a Screwed Rod running from the upper Flanged Wheel to the inside of the boiler, the final touch of realism being added by a spark arrestor—an unmodified kettle scourer!—which is held in place by a Washer and Nut at the end of the Screwed Rod, the open weave of the kettle scourer being amenable to penetration by tweezers. Water pick-up hose is by courtesy of spring curtain wire, (plastic covered) which enters a Handrail Coupling on top of the water tank and admits a Handrail Support at the "business end" as a filter. Oil lamps are provided by 1 in. loose Pulleys, small Conrates and fixed $\frac{1}{2}$ in. Pulleys secured to three $\frac{1}{2}$ in. Double Brackets. A right-angled Rod and Strip Connector bolted to the back of the lamp carries a 1 in. Rod which drops into a Handrail Support fitted to either side of the Boiler.

Fig. 4 shows further details at the front end of the model, the smoke-box door being a Conical Disc, Part No. 187a, locked on from inside the boiler by a $\frac{1}{2}$ in. Bolt which is first secured to the Boiler End by a lock-nut. The Collar, carrying a short Threaded Pin, is secured by the outside Nut, and the Hinge, Part No. 114, is sandwiched between the Disc and Boiler End at the same time.

Construction of the dynamo begins with the attachment of a $\frac{1}{2}$ in. Bolt in one rim hole of a pair of Boiler Ends by means of lock-nuts. Two $2\frac{1}{2} \times 1\frac{1}{2}$ in. Flexible Plates or Plastic Plates are then secured inside the Boiler Ends by a $1\frac{1}{2}$ in. Strip (see Fig. 3) at the top of the dynamo, a Handrail Support, with a Washer packed below the Strip, completing this section. The instrument board is a $1\frac{1}{2} \times 1\frac{1}{2}$ in. Flat Plate carrying three



Fig. 5: The all-important differential gear which allows the traction engine to steer and perform winch operations.

Collars on $\frac{1}{8}$ in. Bolts which secure the internal Flexible Plates at the front of the dynamo. A heat reflector plate, of similar construction, is attached with standard Bolts to the rear of the dynamo, embellishments at either side of the dynamo being supplied by brass Wheel Discs. Tension Springs, etc. are held in place

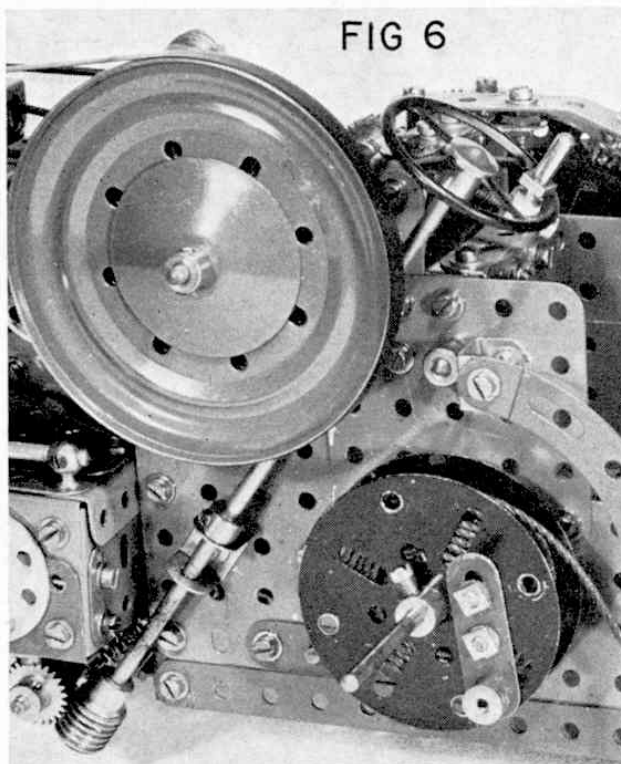

Fig. 6: The winch side of the rear axle. Note the Threaded Crank bolted to the winch drum. This forms the locking point for the drive pin passing through the rear wheel boss.

by Screwed Rods passing through the dynamo case from side to side. The central shaft must be free to spin, as this carries the drive by belt from the Flywheel.

A double flange dynamo pulley is made as follows: the dynamo shaft carries a Rod Socket, Part No. 179, to which a $\frac{3}{4}$ in. Washer and Chimney Adaptor are locked by a Threaded Boss. The outside $\frac{3}{4}$ in. Washer is then bolted to the other end of the Threaded Boss to complete the pulley.

Front axle mounting is important and it is a mistake to use a ball race at this point or to use a fixed swivel which will not allow the front axle to "float". It must be able to ride over bumps without tilting the engine. Fig. 4 gives one solution with double thickness of Narrow Strips bolted to Couplings to form independent axle journals. If double wheels are used to improve the appearance and rugged qualities of the front end of the traction engine, they must be locked to stub axles which must be free to revolve independently if the model is to steer properly. Collars fitted with $\frac{7}{64}$ in. Grub Screws, Part No. 69c, are fixed to the inside ends of the stub axles running in the Couplings. The axle pivot is

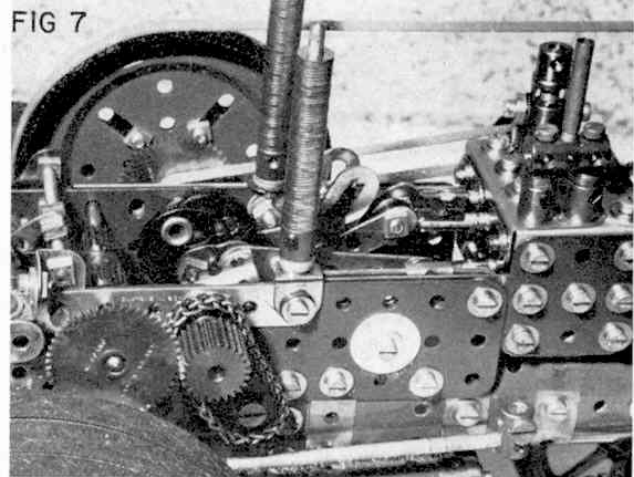

Fig. 7: A compact arrangement of valve and piston connecting rods. Note the Slotted Strips simulating reversing slides. These oscillate in opposition to the valve gear with great realism.

provided by a pair of 1 in. Triangular Plates bolted to a Coupling carried on a Long Threaded Pin which passes up through the Double Bent Strip and is secured inside the boiler with a Collar. The Double Bent Strip is bolted directly to the boiler and carries a $\frac{1}{2}$ in. Double Bracket fitted with a Single Bent Strip, Part No. 102, as a towing bracket. Several $\frac{3}{4}$ in. Washers give the necessary height adjustment and swivelling pad.

Fig. 1 shows alternative axle arrangements, retaining the "spud" pan as a carry-over from solid-wheel days by certain manufacturers. A 2 in. Sprocket Wheel receives the chain steering, but, again, the front axle is free to pivot universally. Prototype road locomotives had a short, but heavy transverse leaf spring across the front axle to smooth the ride and to give some stability to the front end of the engine.

As in any vehicle, change of direction always means a change in speed between the back wheels as one has to cover a greater turning circle than the other, particularly on sharp turns. The traction engine is no exception and an excellent differential gear, suitable to the scale under discussion, is shown in Fig. 5. It needs careful assembly, adjustment and packing with selected Washers, including electrical Thin brass Washers, but, when driven by the combined motor and gearbox unit, it is very effective indeed. Basically, a

FIG 8

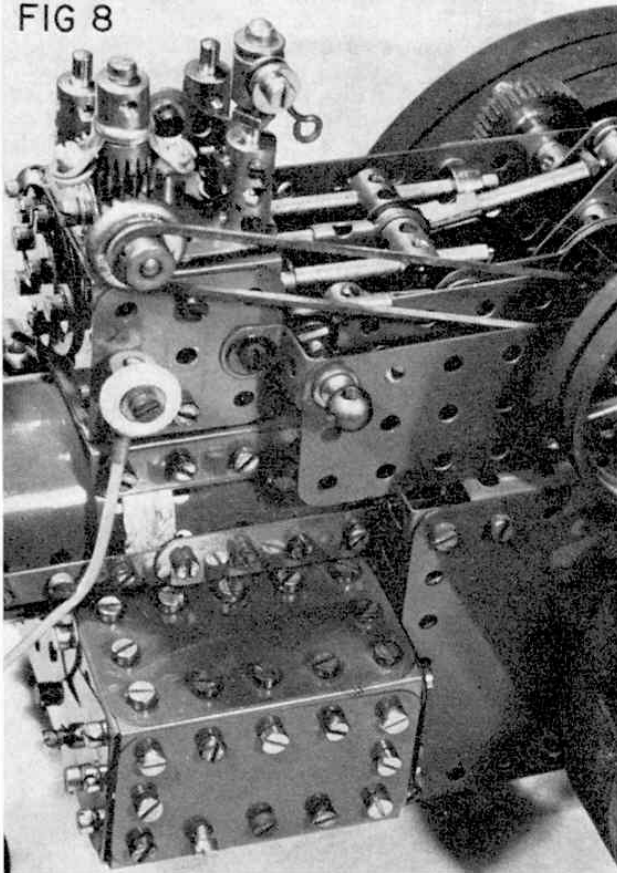

Fig. 8: A single-cylinder engine with double cross-head slide and eccentric valve. Note the belt drive to the boss of the contra governor gear and bleed valve on the side of the steam chest made from a Dinky Toy tyre, electrical Thin Washer, Short Coupling and Spring Cord.

differential gear must be capable of passing on the transmission to both rear wheels at all times when the vehicle is in motion, despite differences in speed between the wheels. The $3\frac{1}{2}$ in. Gear Ring shown in Fig. 5 has the advantage of peripheral holes which will accept the Threaded Couplings shown and will also allow the Gear Ring to be bolted to a $2\frac{1}{2}$ in. Gear Wheel, which, of course, centres the Gear Ring accurately. The Threaded Couplings hold fixed stub axles on which $\frac{1}{2}$ in. Bevel Gears are free to rotate. The central Coupling is free to spin on the rear axle which passes right through the model, the Coupling maintaining alignment of the stub axles and centralising the radial distance of the small Bevels. Care and patience in critical Washer spacing pays dividends at this stage.

The $1\frac{1}{2}$ in. Bevel Gear lying between the Coupling and the $2\frac{1}{2}$ in. Gear Wheel must also be critically spaced with packing Washers so that it meshes cleanly with the small Bevels without binding. The large Bevel is then locked firmly to the rear axle with double Set Screws, while the outer $1\frac{1}{2}$ in. Bevel Gear is bolted directly to the Hub Disc forming the inner part of the rear wheel, its boss projecting through the large hole in the centre. Again, critical packing Washers are placed on the rear axle prior to putting the rear wheel in place, where it is held in position by a Collar at the outside end of the rear axle. This second large Bevel carries no Set Screws as it receives its motion directly from the differential gears. The rear side of the rear axle carries a winch drum made from Face Plates locked to the rear axle and this means that the winch is always turning if

the back axle is in motion. A Threaded Crank, Fig. 6, bolted to the winch drum, receives a long Bolt passing right through the rear near-side wheel which is withdrawn when winching operation take place. When in place, the Bolt couples the winch drum to the wheel for travelling.

Also illustrated in Fig. 6 is the steering column and worm drive steering mechanism, and the flywheel, the latter made from a pair of Ball Thrust Race Flanged Discs. Careful assembly of these Discs on a Bush Wheel or Gear Wheel incorporated in the main gearing will ensure the concentric running which is essential for trouble-free dynamo drive. Once set up accurately, the dynamo drive will run continuously, belts being supplied by elastic, thin leather or P.V.C. strip.

Valve gear and piston rod motion present quite a challenge in the confined spaces available in models of the type described here, but Fig. 7 shows a very compact assembly embodying two eccentrics and a crank in a very confined space—a feat which requires the art of the experienced constructor. Fig. 8 shows a simpler motion with single crank, double cross-slide and single eccentric.

Steam chests can be moulded from small Flexible Plates, Threaded Bosses being a great asset inside the chest, where they become versatile “nuts” to which external Bolts, Threaded Pins, etc. can be easily attached. Steam whistles, etc. are easily modelled from Threaded Bosses, Contact Screws, Washers and small Wire

Continued on page 466

FIG 9

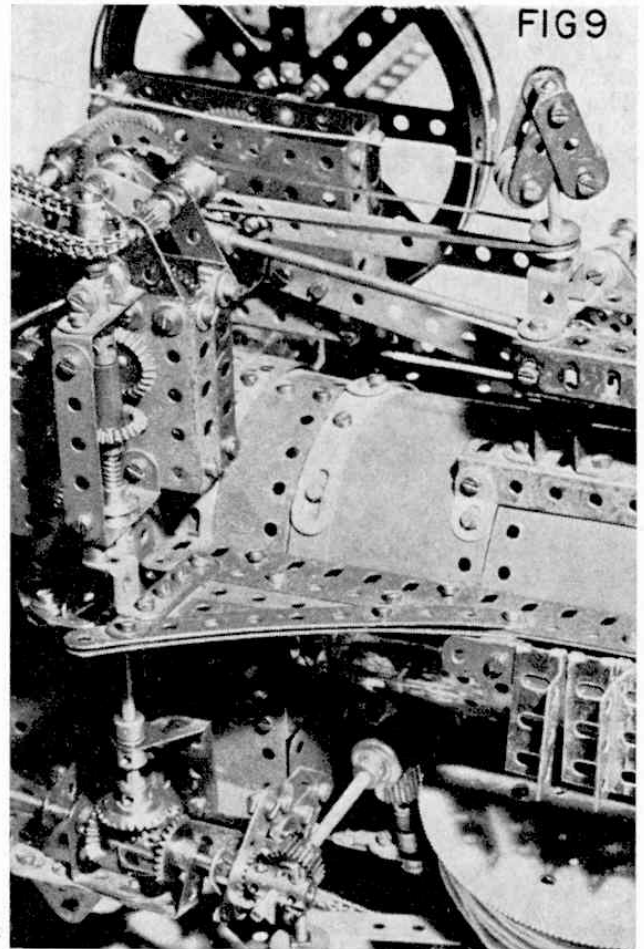

Fig. 9: A larger scale traction engine with ample room for valve gear and pistons. Note power take-off for ploughing winch via screw-operated spring-loaded clutch.

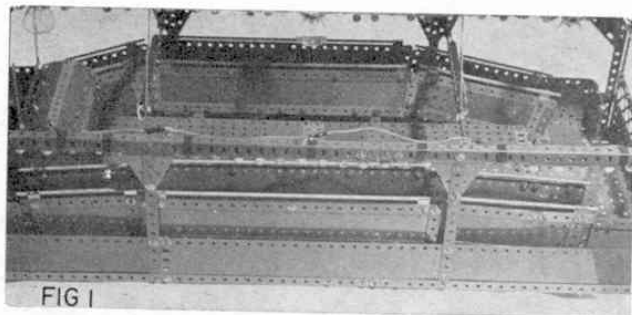

Fig. 1. A simple two-stage "Cake-walk". Each platform is in three sections with slide bearings at each end and two hinged "breaks" on the walks.

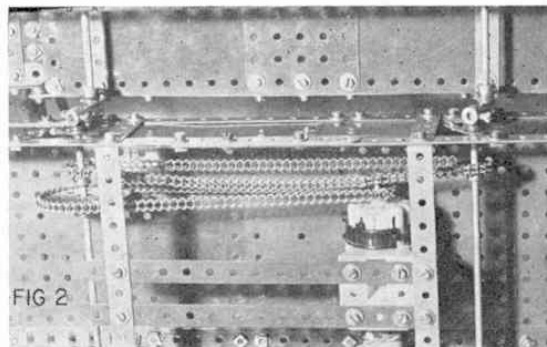

Fig. 2. The simple chain drive to the cranks under each oscillating platform in the "Cake-walk". The crank rods extend to both platforms, but the Couplings forming the crank webs are off-set at either end.

MECCANO CONSTRUCTORS

GUIDE by B. N. Love

Part 9: Fairground Machinery

HAMPSTEAD HEATH ON A BANK HOLIDAY, or any similar location, draws tremendous crowds to the traditional Fair which travels all over the countryside. The Public, as a whole, are fascinated if not spellbound by the huge fairground machines in motion and are always ready to place themselves at the mercy of these mechanical monsters to have their insides shaken unmercifully. Some excellent fairground models have been published in Meccano Magazine from time to time, with comprehensive descriptions of the special mechanisms required to produce the compound motions of such exciting machines as the "Octopus" or the "Satellite" and the fairground is a rich source for other Meccano modelling ideas. Mechanisms abound from the simplest oscillating or

rotary motions to the complex compound motions, so that the enthusiast can work his way through the available fairground "rides" according to the parts at his disposal.

A great favourite of our forebears, young and old alike, was the "Cake-walk"—a pair of reciprocating platforms which were negotiated by the "walkers" with many a hysterical shriek from Victorian sporting ladies who ventured upon it. Its popularity survives to this day and is a simple subject to model in Meccano. Fig. 1 shows the general arrangement of the "walks" which are raised platforms, side by side, driven from below by a reciprocating mechanism that rocks the two sides of the Cake-walk in opposite directions—just to make the "walkers" ever more giddy as both walks

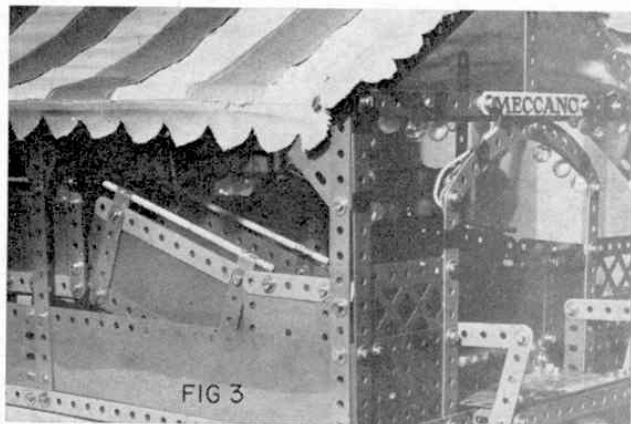

Fig. 3. A gay striped canopy and attractive entrance give added realism to fairground models. Note the "break" in the first cake-walk platform which occurs just before the attachment of the cranks from below.

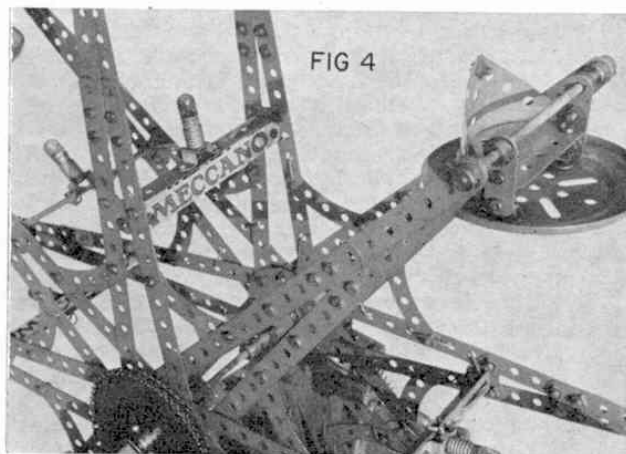

Fig. 4. A simple arrangement for the arms and passenger cars of an open Ferris Wheel.

need to be negotiated before the exit platform is reached. Fig. 2 shows the simple arrangement of the mechanism which is driven through chain-drive and cranks by a 3-12 volt D.C. Motor with 6-ratio Gear Box. Although simple in principle, the Cake-walk is an attractive model and, when fitted with lights, a gay canopy of striped material, entrance steps and a pay-box, it has all the realistic flair of the genuine article.

The Showman's aim is to thrill and delight his customers or to exploit their human weaknesses for financial gain—according to one's point of view, but his machinery has remained basically simple for more than a hundred years. The simple Ferris Wheel is always well patronised, being an ideal 'stomach displacer' as the passengers ride through a great arc on its periphery, and this is another simple machine to model in Meccano. Various lengths of Perforated Strips, from $7\frac{1}{2}$ in. upwards, are the most usual components for the wheel spokes, Face Plates forming central hubs to which the radial spokes are attached. A separation by $4\frac{1}{2}$ in. Double Angle Strips would give satisfactory proportions to a wheel of about 20 in. diameter and this will accommodate eight passenger cars, or "cupolas", quite nicely. Fig. 4 shows one of the many variations of passenger cars suitable for Ferris Wheels, but these can be made in a variety of ways with some thought given to exploiting the more interesting shapes which present themselves in the range of Meccano parts.

An interesting development of the Ferris Wheel is the replacement of the main wheel with a rotating boom which carries a separate and smaller Ferris Wheel at each end. By arranging drives both to the boom and the wheels and selecting appropriate gear relationships, some very interesting geometrical paths are traced out by the unfortunate fairground devotee as he is hurled through equilateral triangles and other uncomfortable loci in a vertical plane, much akin to those provided by the "Whip" at ground level. Fig. 5 shows a simple epicyclic gear mounted at the boom centre of such a contra-rotating "Double Ferris Wheel" which passes on the drive to the outer wheels in one of the geometrical paths outlined above. The $1\frac{1}{2}$ in. Contra Wheel is bolted to the 57-teeth Gear Wheel, both of which are free to revolve on the main central shaft, this shaft not only turning the main boom, but also passing motion to the Contra Wheel via the $\frac{1}{2}$ in. Pinion train shown. The 25-teeth Pinions meshing with the Contra Wheel pass on the motion to the two separate wheels in the correct phase to give the desired locus of travel for each passenger car.

Very strong Ferris Wheels of large diameters can be built from standard Meccano parts if the enthusiast is in a position to command a large collection of parts. Axle Rods joined by Couplings provide spokes which can build up a 6 ft. diameter wheel of elegant proportions. By using hub cheeks made of 3 in. Sprocket Wheels, to which $3\frac{1}{2}$ in. Gear Rings are bolted in spaced pairs, a 32-spoke hub is quite easily constructed. The Axle Rods forming wheel spokes are fitted with Strip Couplings which are, in turn, fastened by Meccano Hinges to the peripheral holes of the Gear Ring. This hinge arrangement allows all of the spokes to be doubled up by using two hinges at one hub anchoring point and allowing for one spoke to go straight out to the rim of the Ferris wheel, or to be slightly angled to give a 'dished' construction, while the inside spoke from the same hinge root goes across at a greater angle to meet the wheel rim on the far side. This gives very strong bracing to the wheel and is the method employed on demonstration models

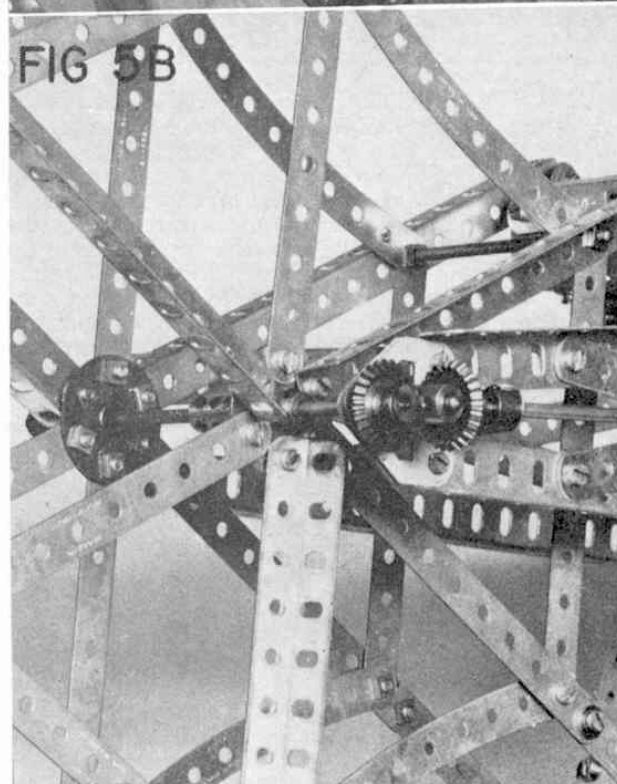
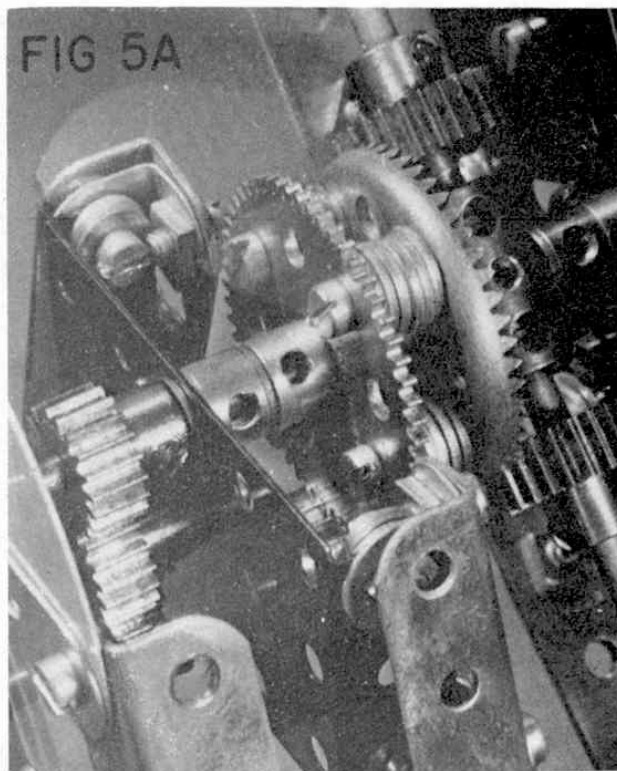

Upper: Fig. 5a. A simple, but effective epicyclic drive for contra-rotating Double Ferris Wheels.

Lower: Fig. 5b. The Bevel drive to the individual wheels on the rotating boom of a Double Ferris Wheel. This drive is taken from the $\frac{3}{8}$ in. Pinions shown in Fig. 5a.

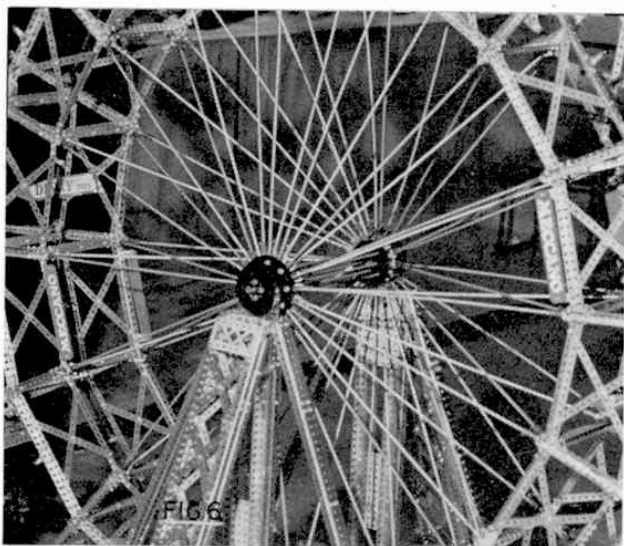

Fig. 6. Giant Ferris Wheels of 6 ft. diameter and more can be built by liberal use of Rods and Couplings. Heavy hub sections are constructed from 3 in. Sprocket Wheels and $3\frac{1}{2}$ in. Gear Rings. Note the built-up central shaft reinforced with long Screwed Rods which runs in "square" bearings as described in the text.

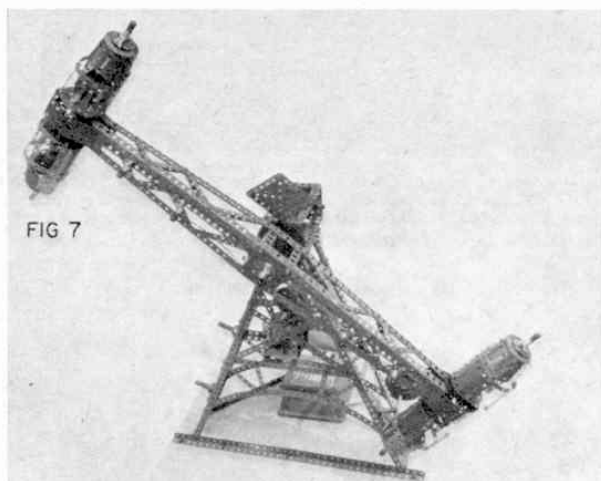

Fig. 7. Whirling "Torpedoes" make a fascinating display model with revolving aerocars driven through simple gearing.

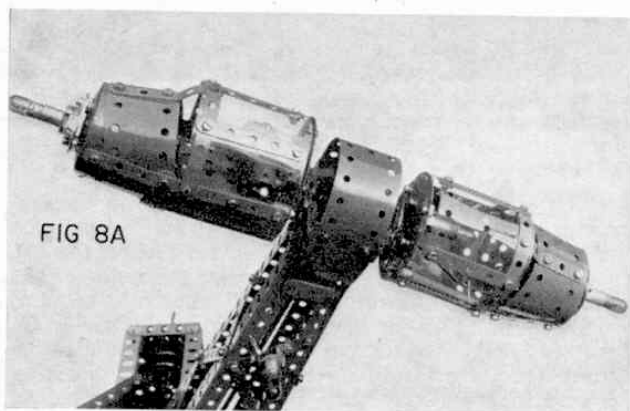

Fig. 8a. A pair of cars from the "Torpedoes" fitted back to back on the same shaft. Passenger seats and "navigation" lights add to the realism.

which have to run for long periods in exhibitions. Fig. 6 shows a portion of such a wheel.

As a diversion from the contra-rotating Double Ferris Wheel, the rotating boom has been put to good use in an even more fiendish piece of machinery in the shape of the "Torpedoes". This makes a fascinating Meccano model and requires quite simple gearing. The general arrangement of the passenger cars is shown at the boom end in Fig. 8a. Apart from rotation of the main boom, each passenger car revolves on its own axis, thus imparting a helix, or screw-form locus in a circular orbit to the passenger. This type of machinery can have the boom supported between large 'A' frames but the overhang, or cantilever form shown is quite common and is often designed in this manner so that the vertical plane in which the boom rotates can also be given a tilting motion just to add to the thrills.

While the section of the model illustrated in Fig. 9 is confined to vertical plane rotation, the cantilever or over-hung central shaft must be of substantial proportions. It is, in fact, made from long Screwed Rods and Wheel Discs, the Rods themselves passing right through a large bearing at the front of the model. This means that the shaft on which the boom is carried is almost the diameter of a Wheel Disc—some $1\frac{1}{2}$ in. diameter, although its construction is in cage form. The important part is the front end bearing which really carries all the weight of the rotating structure. This is simply a square box made from 1×1 in. Angle Brackets mounted in a framework of short Angle Girders with Nuts and Bolts selectively placed in the corners of the assembly, where they will not foul the large-diameter compound axle. By placing several thicknesses of Wheel Discs together on the Screwed Rods at this point, a large rolling surface is rotating inside of a 'square' bearing—unorthodox, but quite strong and efficient at low speed, so long as the bearing is packed with grease. Motor car grease is quite suitable, but oil must be avoided. Long Screwed Rods pass right through the eight holes available in the 3 in. Sprockets and into a thick sandwich of 8-hole Wheel Discs at each end of the main axle assembly. A 'square' bearing is mounted at the top of each massive 'A' frame and the support given is quite adequate for the heavy wheel revolving at the low speed of a fairground model.

In the case of the cage shaft used for the over-hanging boom of the "Torpedoes", only one of these 'square' bearings is used, i.e. at the front, where the main weight is carried. Running through the centre of the cage shaft is a fixed Axle Rod secured in a Bush Wheel bolted to a $2\frac{1}{2}$ in. square Plate at the rear of the model. This allows a pair of 8-hole Wheel Discs at the rear end of the cage shaft to rotate on a "dead" centre and at the same time to be held in place literally by a pair of Collars, thus positioning the other Wheel Discs at the other end of the cage in the correct lateral position inside the front 'square' bearing. The fixed centre Axle Rod runs right through into the centre structure of the rotating boom where it holds a fixed $1\frac{1}{2}$ in. Contra Wheel. A pair of $\frac{1}{2}$ in. Pinions run round the fixed Contra Wheel in epicyclic motion to pass on rotation to the aerocars or torpedoes through the long Axle Rods in the arms of the boom. Final drive to the cars is by Pinion and small Contra Wheel, as shown in Fig. 8b.

Traditionally, the central feature of all fairgrounds for more than a hundred years is the Roundabout, Carousel or Gallopers and these machines offer an excellent subject for Meccano Modelling. Fig. 10

shows just one of the hundreds of examples of which the Meccano system is capable and the model illustrated is built as far as possible on the lines of basic prototypes. Meccano models have appeared from time to time employing a heavy base turntable and this is basically wrong as the showman could never transport such a heavy turntable across country. Instead, for the early types of travelling fairs, a pivot truck formed the centre of a set of gallopers. The truck carried the steam engine, to drive the "ride", as well as the smoke stack and the central "mast", or pivot, on which a heavy crown wheel and bevel gearing was mounted. The truck wheels and frame were heavily shored and wedged with timber to give a stable centre pivot and the sections of the roundabout were suspended from 'spider' arms rigged to a stout centre mast through which the exhaust gases from the steam engine were vented.

Although modern gallopers are fitted with electric motors and electrically-driven "steam" organs, traditionally they still follow the centre truck design. Fig. 11 illustrates the heart of a Meccano roundabout capable of driving 24 gallopers. The centre support is an octagonal pillar made from Angle Girders and Flexible Plates on which a Circular Girder is mounted. A simple ring roller race made from Curved Strips carries eight $\frac{1}{2}$ in. Pulleys, over which a second Circular Girder runs on a self-centring path. This second Circular Girder is reinforced with short Strips and Flexible Plates to form an octagonal 'skirt' which revolves outside the central octagonal pillar. Bolted to the top Circular Girder are eight 1×1 in. Angle Brackets carrying free-running $\frac{1}{2}$ in. Pinions on Short Threaded Pins fixed in their horizontal lugs, the vertical lugs providing a thrust bearing for $\frac{3}{4}$ in. Contrate Wheels in direct mesh with the Pinions. As the roller race carrying the $\frac{1}{2}$ in. Pulleys is "hollow", a $3\frac{1}{2}$ in. Gear Ring may be secured rigidly at the top of the central pillar by a series of Reversed Angle Brackets.

The object now is to get the whole superstructure revolving about the fixed gear ring so that the eight $\frac{1}{2}$ in. Pinions will run round the ring and pass on their motion to the Contrate Wheels. Both in the large-scale machine and the Meccano model, the superstructure has very considerable inertia, i.e. resistance to motion when in the stopped position, and, as the drive must be transmitted from the centre of the roundabout, considerable torque must be supplied. This asks a great deal from a Meccano-size Axle Rod, but the hollow centre bearing lends itself to the 'cage' axle design already described. If a single Axle Rod is used for the central drive, adequate means must be provided for securing driving gears etc. to the Rod. It must also be suitably geared by providing a large Gear Wheel of $2\frac{1}{2}$ in. or $3\frac{1}{2}$ in. diameter at its lower end and this should be reinforced with a Sprocket Wheel with a large boss to give a total of four Set Screws gripping the Axle, the Sprocket Wheel being bolted directly to the large Gear Wheel. At the upper end of the central Axle Rod, two Face Plates are provided, careful fitting of which is very important. The lower Face Plate carries eight $\frac{1}{2}$ in. Angle Brackets to form inner bearings for the 3 in. Axle Rods carrying the Contrate Wheels, and the height of this Face Plate is adjusted to give a slight tilt to the 3 in. Rods for easing the meshing between Contrates, Pinions and Gear Ring. It is then locked into place with two Set Screws. The upper Face Plate carries eight $7\frac{1}{2}$ in. Perforated Strips (only four shown in Fig. 11 for clarity) which are slightly "sprung" by long Bolts

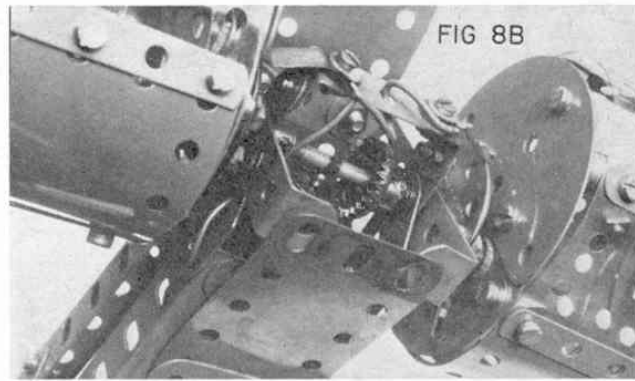

Fig. 8b. Close up view of the Contrate Wheel between the Torpedo's passenger cars with flexible cover plate removed. This gear receives a drive from a $\frac{1}{2}$ in. Pinion fitted to a long Axle Rod running to a $1\frac{1}{2}$ in. Contrate locked to a stationary Rod at the centre of the rotating boom.

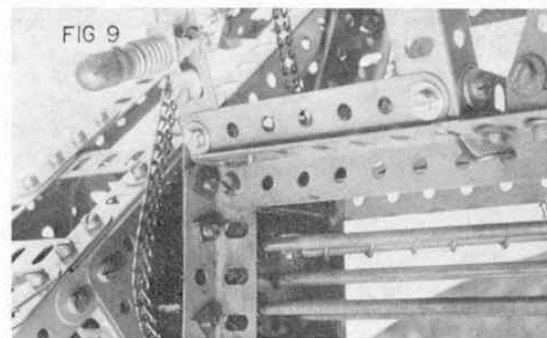

Fig. 9. The 'cage' shaft built from Screwed Rods and stacked Wheel Discs which supports the overhanging rotating boom for the "Torpedoes" in the 'square' bearing mentioned in the text.

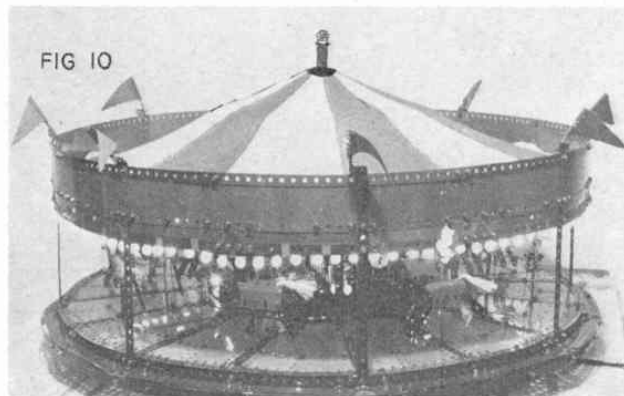

Fig. 10. The ever popular Roundabout, Carousel, or Gallopers—a challenging Meccano subject. Canopy, flags and chimney details again add to the realism.

at their extremities to support the rotating superstructure. However, as these suspension arms pass out through gaps between the Contrate Gears, the top Face Plate must be staggered between the holes of the lower Face Plate and must also be locked to it to form a solid hub. This is done by means of four $\frac{1}{2}$ in. Reversed Angle Brackets. We now have four Set Screws (or long Grub Screws) available for securing the hub to the Axle Rod. By this method, standard parts provide all the grip required without the necessity of filing flats on Axle Rods.

Continued on page 517