

JUNE 1925

MECCANO

MAGAZINE

PRICE
3^D
VOL. X
N° 6



SWISS
MOUNTAIN
RAILWAYS
(See Page 266)

“Miss America”

The World's best value in Steam Model Launches

A BOY'S DELIGHT

Here's a tophole little launch which just buzzes through the water under her own steam. Thousands of boys are already having hours of delight with them on yacht pond or calm river. It is a three-guinea model for 12/6—beautifully finished, strong and well made.

**GOES 20 MINUTES
AT ONE FILLING**

There is a real little engine and the new safety lamp raises a head of steam in very few minutes. A safety valve is fitted to the boiler and the oscillating cylinder turns the little twin bladed propeller to drive the boat 20 minutes at one filling.

**NOTHING LIKE IT FOR
PRICE ANYWHERE**

“Miss America” is 2 ft. 6 ins. long, and has a 3½ ins. beam. She is finished off in three brilliant colours of enamel, and made to ride the water gracefully and easily. A tiller is provided so the boat can be steered, and a filler, lamp, and full instructions are supplied with each boat.

12/6 Complete
Postage abroad
9d. extra.

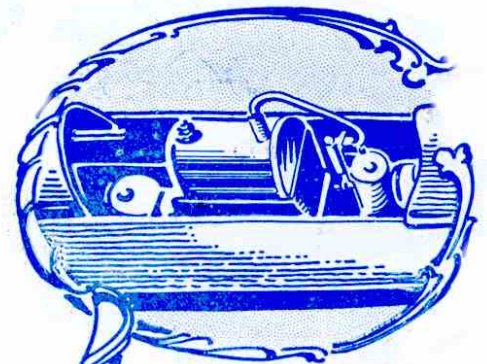

Free to Meccano Readers

A short pamphlet giving full details of the launch will be sent to any reader who sends a post-card for one to Department 960.

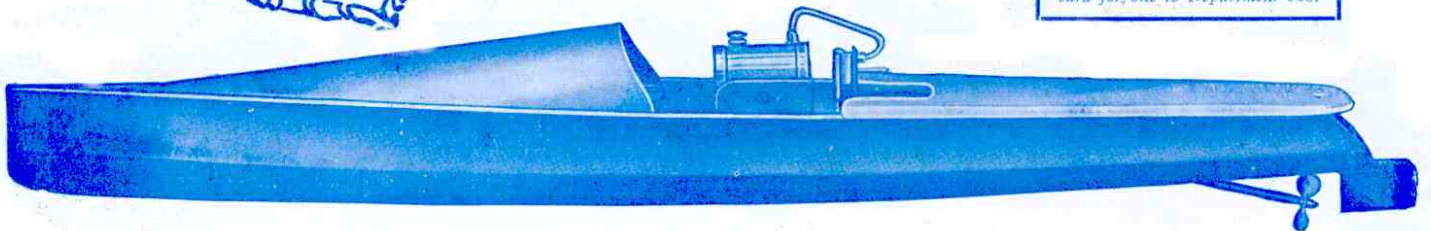

**WHERE
YOU CAN
BUY THEM**

Hobbies Ltd. (Miss America Department), Dereham, Norfolk

Or from Hobbies Branches at London, Glasgow, Manchester, Birmingham, Leeds, Southampton, Brighton or Sheffield. From most good stores and sports houses and the usual Hobbies Agencies. Also at 45, Colborne St., Toronto, Canada.

EDITORIAL OFFICE

Binns Road.

LIVERPOOL

Vol. X, No. 6



PUBLISHED

IN THE INTERESTS

OF BOYS

June 1925

With the Editor

Our Cover

Our cover this month shows a view on the Rigi Railway, one of the famous mountain railways of Switzerland. The electric coach is seen climbing a narrow track that runs along the edge of a precipice, as it winds its way up the mountain. Swiss Mountain Railways are described in a special article in this month's issue by Mr. H. J. Shepstone, F.R.G.S., the well-known author and traveller, whom we welcome as a new contributor to our pages. Mr. Shepstone has promised us several other interesting articles in the near future, including an account of the building of the Sennar Dam across the Nile. The construction of this gigantic work is a particular triumph for engineers because not only was the work carried out in the face of great difficulties, but the engineers literally had to race with Nature so as to get the dam completed before the annual floods of the Nile set in.

Next Month

The July issue will include the first instalment of an article comparing Swiss, French, and English railways. This article has been specially written for us by Mr. H. E. Underwood, who lives in Geneva. Mr. Underwood, who has been a member of the Meccano Guild for many years, has contributed interesting news items to the "M.M." for some time past, and he is now acting as our special correspondent at Geneva. He is particularly interested in railways and has promised to send us some splendid articles dealing with Swiss Railways and engineering works. I feel sure that my readers will look forward to these features, which will be published as opportunity permits.

For Our Cycling Readers

Our contributor "Rover," next month commences a special serial article describing a tour in Somerset and Devon. Although it may not be possible for a large number of our readers to go over the same ground, I feel sure that all cyclists will be interested in reading the new series. They are written in a somewhat different style from that which "Rover" has hitherto adopted and they contain a good deal of helpful instructions to cyclists generally, as well as some reading in lighter vein.

Cycling tours are very similar no-matter in what part of the country they are made, the only differences being the scenery, the nature of the road, and the incidents on route. "Rover" is a confirmed cyclist and has averaged 5,000 miles every year for many years. He thinks there is nothing like cycling to keep one fit! I hope that his enthusiasm for cycling will be infectious and that a large number of my readers will be persuaded to get out into the country on tour during the holidays this summer.

A "Fishy" Subject

This month I am commencing a special series of articles on Aquariums and, as a result, many readers will no doubt be tempted to set up a tank or a bell-jar and to stock it with interesting specimens. I feel sure that these articles will be appreciated. No doubt many who already have aquariums—or even who keep the humble stickleback or tadpole in a jam-jar!—will learn with surprise that there is such a thing as cruelty to fishes, and that it is as easy to be kind to creatures that live in water as to those that live on land. No doubt a good deal of pain is inflicted unknowingly upon the inhabitants of an aquarium, but after reading what our contributor has to say on the subject there should be no excuse for any form of "cruelty to fishes."

The Railway Centenary

As most of my readers know, this year is the Centenary of the steam locomotive, and special celebrations are being held in the north of England to commemorate this anniversary. Although the first train on the Stockton and Darlington Railway ran on 27th September 1825, the centenary celebrations are being held in July next at the particular request of the international Railway Congress, which represents the railways of the world. The Congress meets in different countries every year, and for 1925 the meeting was to have been held in Madrid. Owing to the reports of the centenary of British Railways, however, the Congress Committee suggested that if the centenary celebrations could be held in July they would hold their session in London. For this reason it has been decided to celebrate the birth of the railway systems of the world on the site of the original Stockton and Darlington Railway on the 2nd and 3rd July next, instead of holding the celebrations on the actual anniversary of the opening of the railway.

A special Railway Centenary number of the "M.M." will be published in September, and in addition to splendid articles on the history of the locomotive, modern locomotives, and other railway features, it will contain a full description of the Centenary Celebrations. A special representative is being sent to Darlington so that the events may be fully described and illustrated. Further particulars will be published later.

A Famous Author's Centenary

Speaking of centenaries, I read that the centenary of R. M. Ballantyne, the famous author of boys' stories, has recently been celebrated in Edinburgh. Robert M. Ballantyne was born on the 24th April, 1825, and when sixteen years of age received an appointment with the Hudson Bay Fur Co. Although his salary was only £20 a year, we imagine that a good number of our readers would have envied him, for his work lay among the traders and Red Indians in North America. The life was too severe, however, and so affected his health that he had to return to Scotland after six years of adventure.

In 1855, William Nelson, the famous Edinburgh publisher, suggested he should write a book for boys dealing with his experiences and adventures. Next year "The Young Fur Traders" was published and meeting with great success, was followed by two other books, which dealt with adventures in different parts of the world. The scenes were laid in countries that Ballantyne had never seen, with the result that in his third book "Coral Island" he made at least one great blunder. On this mistake being pointed out to him he determined never to write another book without first "obtaining information from the fountain head." With this maxim in mind he went to stay at Ramsgate and made friends with Jarman, the local coxswain, before writing "The Life-boat." He visited the Bell Rock before writing "The Lighthouse" and for his splendid book "Fighting the Flames," he served with the London Salvage Corps as an amateur fireman.

I hope that any of my readers who have not read Ballantyne's books will do so without delay, for they include some of the finest boys' stories that have ever been written. In this connection I wonder if any reader will be able to point out the blunder that appears in "Coral Island." I shall award a cheque for a guinea to the sender of the first correct solution received before 31st August. Mark your envelopes "Coral Island" and do not forget to include your name and address.

Swiss Mountain Railways

Track-laying in Cloudland

By H. J. Shepstone, F.R.G.S.

THE Alps have been the scene of many battles-royal between skilled engineers and the towering peaks with their everlasting snows.

One of these battles is now in progress on the Aiguille du Midi, the companion peak of Mont Blanc. The engineers are endeavouring to throw a cableway to the summit of this famous peak. Operations were commenced as far back as 1909, and by the time the Great War broke out and put a stop to the operations a height of 4,099 ft. had been gained. A strenuous attempt is now being made to carry through the original scheme, that is to construct an aerial line capable of carrying passengers to the summit of the Aiguille du Midi—12,608 ft. above sea level. The cables on which the cars will run, swinging in the air as it were, are being carried up the mountain side on steel towers varying in height from 38 ft. to 108 ft. Each of these cars will be designed to carry twenty passengers and the motive power will be electricity.

The Avalanche Danger

The engineers have undertaken to reach an altitude of 9,080 ft. next year, but after that progress will prove exceptionally difficult. The work is extremely risky in many respects, but above all there is the danger of avalanches which are very frequent on the higher reaches of this peak. Geologists who have studied this mountain tell us that these avalanches frequently contain as much as 150,000 cubic yards of snow, stone and earth!

This is by no means the first attempt to construct a passenger cableway up the steep sides of a great mountain. The Kohlerer Mountain Railway in the Austrian Tyrol, for instance, has been in constant operation for some years. In this case, however, the mountain is only 4,000 ft. high and has only two stations, one at the base and the other at the summit. Shortly before the war an aerial line was built to the edge of the Wetterhorn, its object being to raise passengers some 2,000 ft. to the Upper Glacier. Owing to the war this project failed to pay its way and to-day its cables and

machinery are disused and covered in rust.

Snowdon Rack Railway

Whether these aerial lines will supersede the rack railways for scaling dizzy heights is doubtful. Rack railways are now in successful operation in almost all parts of the world where there are mountain ranges. We have an example of this system at Snowdon, where a little rack railway climbs about 2,000 ft. in just over four miles. There was a disastrous accident on this line shortly after it was opened and for a time tourists

were very shy of it. To-day, however, the accident is forgotten and the line is in great demand as a saver of time and bodily fatigue by those who are anxious to reach the highest point in England and Wales.

As regards difficulty of construction and altitude obtained, the Snowdon line is a mere toy compared to the wonderful rack railways that carry passengers up Pilatus, Rigi, Zermatt, Jungfrau and many other mountains in the Swiss Alps.

Conquest of Pilatus

Take, for instance, the Pilatus Railway, which, although it only attains an altitude of just under 7,000 ft., is nevertheless one of the most remarkable of the whole group. This rugged, serrated mountain, called Pilatus from the legend that the spirit of Pontius Pilate is condemned to roam its heights for ever in solitary contemplation of his sins, looks down upon the beautiful shores of Lake Lucerne. It is not by any means the loftiest

of the Alpine peaks, but its great sides and naked rocks, its terrible precipices and its cliffs which rise so grandly into the air made the scaling of it a daring feat on the part of the engineer.

Pilatus is ascended to-day by the iron horse by means of a series of short tunnels and steep outside tracks. The gradient in some places is as much as one foot in every two. The Italian workmen who built the road frequently had to work while suspended at the end of ropes 100 ft. long. Sections of the track had to be hauled up by ropes and then fastened to convenient



The Kohlerer Mountain Aerial Railway

rocks until they could be spiked into position. The work in fact was both dangerous and exhausting.

The wildest part of the road is reached at the point where it enters the rugged escarpment of the Esel.

Here it passes round the fantastic blocks of the Mattalp under the very edge of the enormous mass of the Esel, whence a panoramic view is had of the Matterhorn. From there, describing a sharp curve, the line boldly mounts the ridge that connects the two summits. At this point the

line lies at an altitude of 6,230 ft. above sea level, and it seems to cling to the very edge of the wind-swept, grim, grey peak of the Esel as it mounts slowly upward. Below, the Bernese Alps, lakes, towns and villages can be seen in every direction. Men working on this part of the line had to labour in a most unfriendly climate while toiling against engineering difficulties that were almost insuperable.

A Narrow Escape from Death

An incident that occurred during the building of the railway up the Rigi provides a good example of the dangers of this kind of work. During the operations some workmen loosened from the mountain side a gigantic block of stone weighing over 20 tons, and this went crashing down the narrow road, threatening death and destruction to anything in its path. Five workmen saw the huge stone falling and dashed away into shelter. They were not a second too soon, for just as they reached safety the great block thundered past them! During the construction of the railway to Zermatt one hundred tons of snow from the mountain fell upon the toilers, burying them so deeply that it took a gang of experienced men many hours to dig them out.

Gales spring up very suddenly on these mountains, and as may be imagined the force of the wind on an exposed slope is terrific. For this reason men who are employed at work close to the edge of steep precipices are always roped, and this precaution has been the means of saving many lives. When a great wind has sprung up men have been blown over the face of the cliffs, there

to dangle in mid-air until their comrades pulled them up, safe but bruised and bleeding from cuts received from the jagged points of the rocks. Without ropes these men would have been hurled to a terrible death.

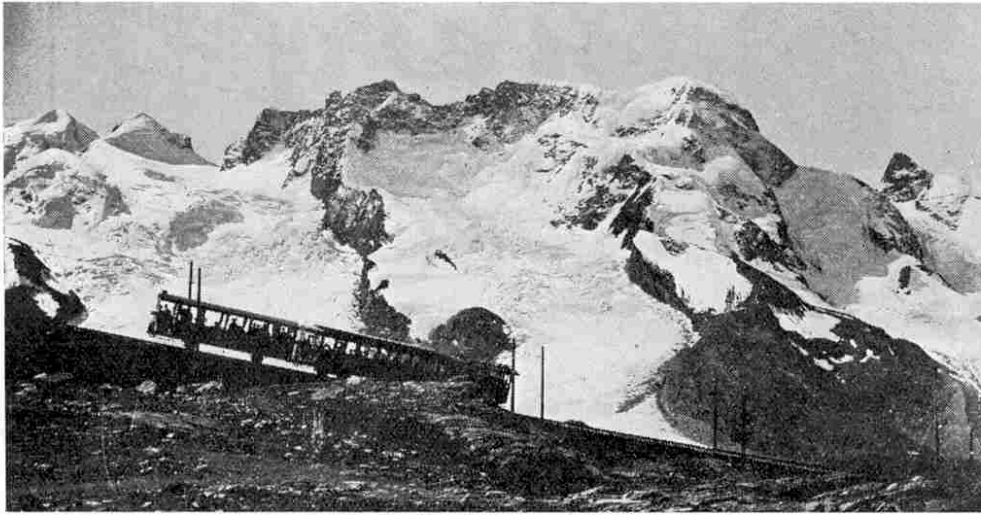

The Zermatt-Gornergrat Railway

By means of the railway, however, one can ascend in comfort to a height of 11,340 ft., that is about 2,330 ft. below the summit. From this point it is quite probable that a lift will be constructed to carry passengers up the remaining portion of the mountain.

A Wonderful Lift

As I write, the engineers are busy erecting a wonderful lift up the last section of the Jungfrau. Until fairly recently it took two or three days' climbing, including some glacier work, to gain the summit of this peak which towers 13,670 ft. into the air.

The Jungfrau Railway is a daring piece of work. It starts at the Little Scheidegg, 6,770 ft. above sea level, and climbs up in the open to Eiger Glacier station, 7,620 ft. high. Here one can step out and explore the glacier and even in midsummer indulge in tobogganning, as the writer did during the heat wave in July last year. From this point the railway plunges into a succession of tunnels between which the traveller gets glimpses of splendid prospects, round the southern face of the Eiger and then across a rocky neck to Eismeer and along the ledges to the Jungfrauoch station—cut in the solid rock—to a point 11,340 ft. above sea level—the highest railway station in Europe.

The construction of this remarkable mountain railway presented enormous difficulties. Five years were spent in surveying the route owing to the extreme difficulty of finding stations for the instruments. As the railway progressed upward only the hardest and strongest men could endure the fatiguing work. Oxygen is scarce at such a height and the workmen soon became exhausted. After two hours' toil long periods of rest had to be taken before the men could start work again.

The rarified state of the atmosphere at high altitudes is a serious hindrance to mountaineers, especially in such undertakings as the climbing of Mount Everest.

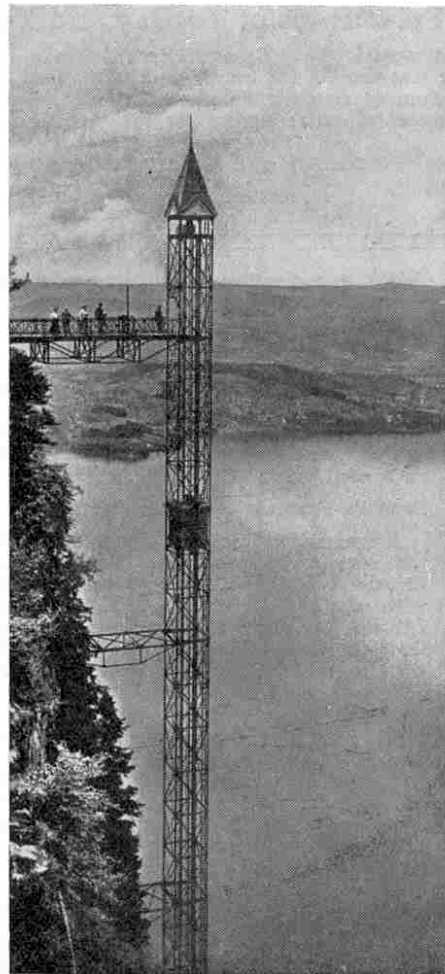

This Elevator, on the Burgenstock Mountain Railway, has a perpendicular rise of 500 ft. up the face of the mountain



Lives of Famous Engineers

XVII
Isambard K. Brunel
and the
"GREAT EASTERN"

LAST month we gave an account of the work of I. K. Brunel as a railway engineer, and this month we must turn to his equally great achievements in steam navigation.

The use of steam in the direct voyage across the Atlantic made by the American ship "*Savannah*," in 1819, drew general attention to the possibilities of the steam engine for purposes of navigation. Little advance in this direction was made, however, until 1835. In that year at a meeting of the Board of the Great Western Railway Company, one of the directors spoke of what he considered to be the "enormous length" of the proposed railway from London to Bristol. Brunel immediately exclaimed, "Why not make it longer and have a steamboat to go from Bristol to New York and call it the "*Great Western*?"

The suggestion was treated as a joke, but afterwards some of the directors discussed the matter with Brunel and ultimately became quite enthusiastic about his scheme. It was not long before a company was formed in Bristol, called The Great Western Steamship Company, and the construction of a ship, the "*Great Western*," was commenced, mainly under the direction of Brunel.

A Trans-Atlantic Controversy

About this time a serious controversy arose in regard to the possibility of successful trans-Atlantic navigation by steam. At a meeting of the British Association in Bristol in 1836 a Doctor Lardner gave an address on "Trans-Atlantic Steam Navigation," in which he made the following remarkable statement:—"Let them take a vessel of 1,600 tons provided with 400 horse power engines. They must take 2½ tons for each horse power, the vessel must have 1,348 tons of coal, and to that add 400 tons, and the vessel must carry a burden of 1,748 tons. He thought that it would be a waste of time, under all the circumstances, to say much more to convince them of the inexpediency of attempting a direct voyage to New York, for in this case 2,080 miles was the longest run a steamer could encounter; at the end of that distance she would require a relay of coals."

Launch of "Great Western"

This statement was widely circulated and made a deep impression, but in spite of all adverse criticism the construction of the "*Great Western*" was proceeded with and she was launched on 19th July 1837. While she was anchored in the Thames she was crowded with visitors who were astonished at her size.

Her engines having been installed, great efforts were made to get the ship to

coal she had taken on board. She found that the "*Sirius*" had arrived before her, but the latter vessel had left Cork eight hours before the "*Great Western*" left Bristol, and had only arrived at New York a few hours before her. Another point of importance was that while the "*Great Western*" had nearly 200 tons of coal left, the "*Sirius*" had not only consumed all her coal but also almost every article on board that would burn, including—according to rumour—a child's doll!

The "*Great Western*" commenced her return voyage with 68 passengers and made the trip in 14 days. From that time she ran regularly between Bristol and New York until the end of 1846. In the following year she was sold to the West India Mail Steam Packet Company. She was broken up in 1857 and Brunel was among those who went to take farewell of her before she finally disappeared.

The principal dimensions of the "*Great Western*" were as follows:—Extreme length 233 ft.; breadth (including paddle boxes) 59 ft. 8 in.; engines 450 h.p.; diameter of paddle wheels 28 ft. 9 in.; total tonnage 1,321 tons.

"Great Britain" Laid Down

The directors of the Great Western Steamship Company, encouraged by the success of the "*Great Western*," decided to lay down a second ship, and further, they determined that the new vessel should be the largest afloat and should be constructed according to the very latest theories. At first it was intended that the new ship should be built of wood, but afterwards the company decided that she should be built of iron. This decision met with almost general condemnation by the public, but the directors of the company persevered. Brunel's second vessel, the "*Great Britain*," was therefore laid down.

By this time the superiority of the screw to paddles was gradually being demonstrated and already several small vessels had been fitted with screws and had proved very successful. So far, however, no attempt had been made to build a screw steamer large enough for ocean voyages. The Great Western Company had intended that the "*Great Britain*" should be a paddle steamer, but they soon became convinced of the superiority of the screw

Giant Steamships of To-Day and Yesterday

Brunel's last vessel, the "*Great Eastern*," was a failure largely because she was too big for her day. The advance that has been made in steamship construction since that time is well shown by the following comparative figures for the "*Great Eastern*" and the "*Majestic*":—

	"Great Western"	"Great Eastern"	"Majestic"
Length	263 ft.	693 ft.	956 ft.
Breadth	59 ft. 8 ins.	83 ft.	100 ft.
Gross Tonnage	1,321	18,915	56,551

Bristol to commence her voyage across the Atlantic before the departure of the "*Sirius*," a vessel bought by the St. Georges Steam Packet Company in order to anticipate the "*Great Western*." The latter vessel started for Bristol on 31st March 1838, but in about a couple of hours a serious fire broke out in her engine room and the vessel was immediately run ashore on a mud bank.

Brunel's Remarkable Escape

A remarkable incident occurred during the extinguishing of this fire. Captain Claxton was at work in the engine room with a fire hose when something heavy fell on him from above. On recovering from the blow he looked to see what had hit him, and found a man lying insensible on the floor with his head covered to the ears with water. Captain Claxton called for a rope, the almost lifeless body was hauled on deck, and it was then seen that the man who had fallen was Brunel himself! He had a very narrow escape from death, but after two or three days he had largely recovered from his injuries.

The fire having been subdued, the ship resumed her voyage to Bristol, arriving there on 2nd April. She started on her first voyage to New York on 8th April with seven passengers on board and arrived at New York on 23rd April, having consumed three-fourths of the

and without hesitation they ordered the design of the vessel to be altered so that a screw could be fitted.

Building Difficulties

The building of this vessel was attended with great difficulties. Her total length was 322 ft. and her beam 51 ft. Her total depth from the underside of the upper deck to the keel was 31 ft. 4 in., and her tonnage was 3,500 tons. At that time no shipbuilder had any experience upon which to draw for the construction of such a vessel, and ship-builders generally were not at all keen on commencing the construction of iron ships. In addition there was a very general belief that a vessel of the size of the "Great Britain" could not be built of iron. The directors were unable to find a contractor for the vessel and were therefore obliged to instal their own plant for building the ship and her engines also. She was constructed under the supervision of Paterson of Bristol, as was also the "Great Western."

The "Great Britain" was launched in 1843 after various more or less serious difficulties in regard to getting her afloat. She sailed for London in January 1845 and although she experienced bad weather she made an average speed of $12\frac{1}{2}$ knots. Her arrival at Blackwall caused intense excitement and thousands of people flocked to see her. She remained five months at Blackwall, during which time she was visited by Queen Victoria, and she then left for Liverpool with about 80 passengers on board.

On 26th July, 1845 she left the Mersey on her first trans-Atlantic voyage and arrived at New York on 10th August having made the passage in 14 days 21 hours. On a subsequent voyage she broke one of the blades of her propeller and got home under canvas after 18 days of very rough weather. She was fitted with a new screw and various improvements were made to increase the supply of steam from her boilers, and early in 1846 she again commenced her Atlantic crossings. In the following September she ran aground in Dundrum Bay on the coast of Ireland and was not refloated until 11 months later. She was so strongly constructed, however, that she was little the worse for this long ordeal. Ultimately she was brought to Liverpool and subsequently placed in the Australian trade.

Brunel and the Screw Propeller

Soon after Brunel had taken the bold step of recommending the adoption of the screw propeller in the "Great Britain" he was invited by the Admiralty to take charge of certain experiments regarding the screw that were about to be made. These experiments were carried out on a fairly extensive scale and were so successful that the Admiralty ordered a number of

vessels to be fitted with the screw, and from that time the paddle wheel was gradually abandoned. Brunel thus had the satisfaction of knowing that he had been mainly instrumental in introducing the screw propeller into the Mercantile Marine, and also in securing its adoption in the Navy.

"Great Eastern" Planned

In 1851 Brunel again became connected with the construction of steamships, in the

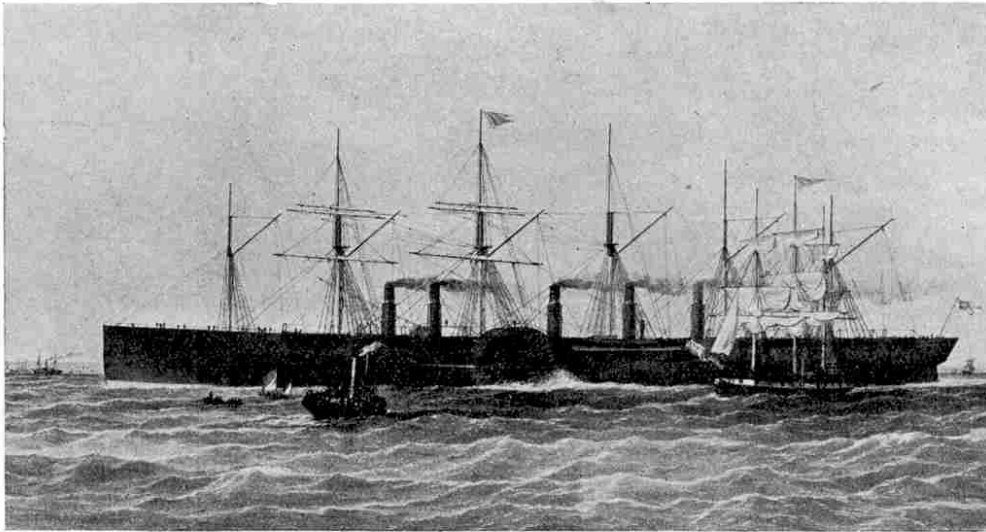

Courtesy of]

The "Great Eastern"

[T. H. Parker

capacity of engineer to the Australian Mail Company. He advised the directors, in order to carry out their contract for the conveyance of mails to Australia, to build ships of from 5,000 to 6,000 tons, in order that they need only touch for coal at the Cape. Two ships were built under Brunel's direction by Mr. J. Scott Russell. These vessels, the "Victoria" and the "Adelaide," were a financial failure, largely on account of the fact that they could not carry enough fuel. This failure led Brunel to attempt to design a vessel large enough to carry her own coal for the voyage. In 1851 the Eastern Navigation Company was formed and decided to build a giant steamer in accordance with Brunel's views. This steamer was the famous and ill-fated "Great Eastern." The lines of the vessel were designed by Scott Russell, who also built the hull, and the general details of construction were settled by Brunel and Russell.

The proposal to build such an enormous ship was received by the public with the greatest enthusiasm and excitement, and all kinds of wild and absurd rumours were floating about in regard to the actual dimensions and estimated speed of the ships.

The Vessel's Dimensions

The "Great Eastern" was provided with both paddle wheels and a screw propeller. She was built of iron with an inner skin from the keel to the water line and was thus a double-hulled vessel. Her chief dimensions were as follows:—Extreme length 693 ft.; breadth 83 ft.; depth 58 ft.; gross tonnage 18,915 tons. Her paddle engines were of 1,000 nominal horse power and weighed 836 tons. The four cylinders were 74 in. in diameter with a stroke of 14 ft. Each paddle wheel was operated by a complete double-

cylinder engine and could be revolved without the other wheel if necessary. Steam was supplied at 24 lb. pressure from four double-ended tubular boilers each $17\frac{1}{2}$ ft. long, 17 ft. 9 in. wide and 13 ft. 9 in. high. Each boiler weighed 50 tons and contained about 40 tons of water. The engines for the screw propeller were of 1,800 nominal horse power and weighed 500 tons. They were supplied with steam at 25 lb. pressure from six double-ended tubular boilers.

The propeller was a four-bladed cast iron screw of 24 ft. diameter and 44 ft. pitch, weighing 36 tons. The vessel's speed under paddle wheels alone was about seven knots and under screw alone about nine knots. Using both screw and paddles her calculated speed was 15 knots.

Launching Troubles

The launching of the "Great Eastern" was fixed for 3rd November, 1857 but on that occasion the great ship moved only a few feet and then stuck fast, and it was not until 31st

January, 1858 that she actually took the water. Her launch was attended with enormous difficulties and dangers, very largely due to the fact that she was launched broadside on to the river. In this matter Brunel certainly made a great mistake, and one which added £120,000 to the cost of the vessel and practically ruined the company.

"Great Eastern's" Career

The "Great Eastern's" bad luck began with her first trial in September 1859, for an explosion occurred which resulted in the death of six men and injuries to several others. Her first voyage was across the Atlantic. She left Southampton on 17th June, 1860 with 36 passengers and arrived at New York on 28th June. Her appearance at New York caused intense excitement and we are told that practically the whole city turned out to see her. On this trip the ship's best day's run was 333 miles and her maximum speed about $14\frac{1}{2}$ knots. On the return trip she carried 212 passengers and a considerable amount of cargo, and made the trip in 9 days 11 hours.

In 1861 she successfully carried over 2,000 troops to Quebec and returned to Liverpool with about 500 passengers. On her next voyage, however, she encountered a great gale in which her steering gear was put out of action, and she was for a time in serious danger of being lost. In 1865 she was employed on laying the Atlantic cables and she continued on this work at intervals until 1886. This cable laying was the most successful work accomplished by the "Great Eastern" and next month her share in this gigantic undertaking will be described in our article on "The Atlantic Cable."

In 1886 the vessel was bought by a firm

(Continued on page 286)

Famous Locos under Test

G.W.R. "Castle" Locos and L.N.E.R. "Pacifics"

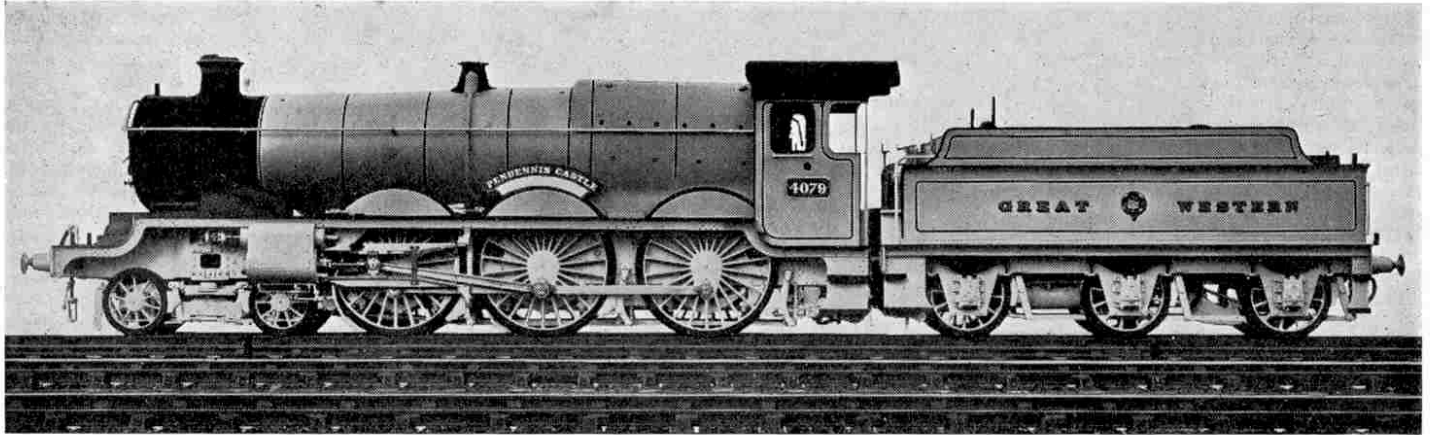

Photo courtesy]

"The Pendennis Castle"

[G.W.R.]

ONE of the most interesting recent events in the railway world is the exchange of locomotives between the G.W.R. and L.N.E.R., by which locomotives of the respective companies carried out a series of trials on the other company's line. The trials were arranged in order to enable the engineers of the two companies to obtain technical information that will be of considerable value and which, no doubt, will not be without some influence in future design.

The 1909 and 1910 Trials

This is by no means the first occasion on which comparative trials of a similar nature have been held. Two that readily occur to the writer are those of 1909, arranged by the L. & N.W., G.N. and Caledonian Railways, and those held from 15th—27th August 1910 between L. & N.W. and G.W. locos.

For these latter trials the G.W. sent their 4-6-0 loco No. 4005, "Polar Star" to the L. & N.W.R. who ran it between Euston and Crewe, train and train with their 4-6-0 loco No. 1455 "Herefordshire." During the week each loco hauled the 12.10 p.m. from Euston, with an average of 17½ coaches, three times, and the 10 a.m. train twice. The procedure was reversed, in the second week of the trials, the 10 a.m. being hauled three times and the 12.10 p.m. twice.

The L. & N.W. sent their loco No.

1471 "Worcestershire" to the G.W. who worked it with No. 4003 "Lode Star" as a comparison. On the Monday of the trials No. 1471 worked the 9 a.m. from Paddington to Bristol and returned with the 5.5 p.m. On Tuesday it hauled the 11 a.m. via Bath and returned with the 5.54 p.m. On Wednesday it took the 10.30 a.m. to Plymouth and returned 8.30 a.m. Tuesday, and on Friday it took the 11.50 a.m. to Plymouth, returning next day with the 9.16 a.m. train. In order to make a better comparison, a G.W. (No. 4003) ran on the same services alternately with the L.N.E.R. No. 1471, and the programmes were repeated during the second week, in the reverse order.

The Recent Trials. "Castles" v. "Pacifics"

The recent trials, which commenced on Monday, 27th April, were between G.W.R. and L.N.E.R. locos and each railway company selected one of their most powerful express passenger locomotives. In both cases these were similar to the locos exhibited at the British Empire

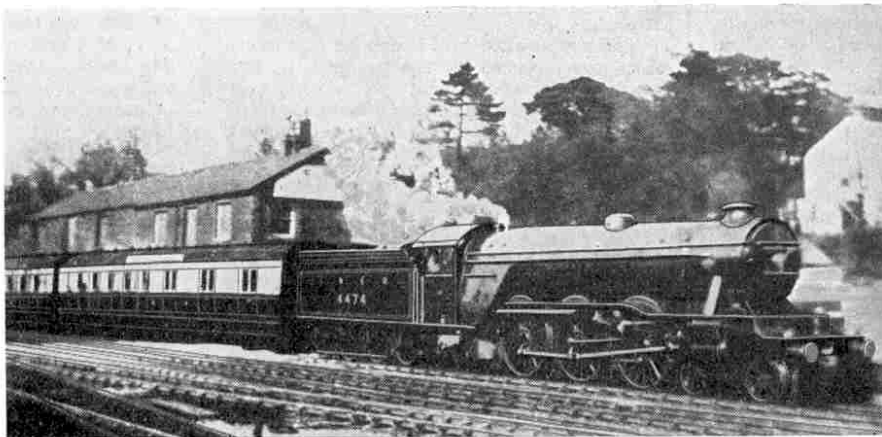

Photo]

A reader's photo of L.N.E.R. 4-6-0 No. 4474 entering Exeter (St. David's) Station the week before the Trials, during a preliminary run

[G. A. Hallett]

Exhibition at Wembley last year, where, no doubt, many of our readers will remember seeing the G.W.R. "Caerphilly Castle" and the L.N.E.R. "Flying Scotsman." Although these famous locos were not used in the trials, the locos actually used were of the same type and similar in every respect.

The L.N.E.R. selected for the trial one of their Doncaster-built "Pacific" type locos, No. 4474, which the G.W.R. set to haul the Cornish Riviera Express between Paddington and Plymouth. The loco was worked down to Plymouth on Monday, Wednesday, and Friday, and returned to Paddington with the "up" Limited express on Tuesday, Thursday, and Saturday.

The G.W.R. worked one of their latest locos of the "Castle" class No. 4074, "*Caldicot Castle*," in conjunction with the L.N.E.R. loco on the Limited Express—that is to say, No. 4074 worked the "down" train when the L.N.E.R. was working the "up," and vice versa.

For the tests on the L.N.E.R. line the G.W.R. selected No. 4079 "*Pendennis Castle*," which on Monday, Wednesday, and Friday worked the 10.10 a.m. Leeds Express between King's Cross and Grantham. It returned to London the same day hauling the 12.30 p.m. express from Harrogate, leaving Grantham at 2.7 p.m. On Tuesday, Thursday, and Saturday, the "*Pendennis Castle*" worked the 1.30 p.m. Leeds Express from King's Cross to Doncaster, returning to London on the same day with the 4.45 p.m. from Harrogate and leaving Doncaster at 6.21 p.m.

Competing Locos Use Standard Coal

One of the points on which comparative information was required was details of the amount of coal and water consumed by the two locos under identical running conditions. To make the comparison as fair as possible, each loco burnt the coal used as the standard for express work on the other company's line. That is to say, the L.N.E.R. loco. ran through the trials on Welsh coal, and the G.W.R. "*Pendennis Castle*" used South Yorkshire coal.

In order to give the competing locos every chance of working up to their normal capabilities, they were manned by the owning companies' crews, and the actual trials were preceded by a week's preliminary running, so that the respective drivers might get accustomed to the "foreign road."

Our Keen Readers

The trials have excited considerable public interest and day by day reports of the varying performances were published in the press. In passing it is interesting to note the keen interest of readers of the "*M.M.*" in the trials, for during the weeks in which the trials and the preliminary runs were held, we received numerous letters from enthusiasts who had seen either the G.W.R. "*Pendennis Castle*" or the L.N.E.R. No. 4474 at some part of their route. Several photographs were also sent to us. The one reproduced on the previous page—showing the L.N.E.R. loco hauling the G.W.

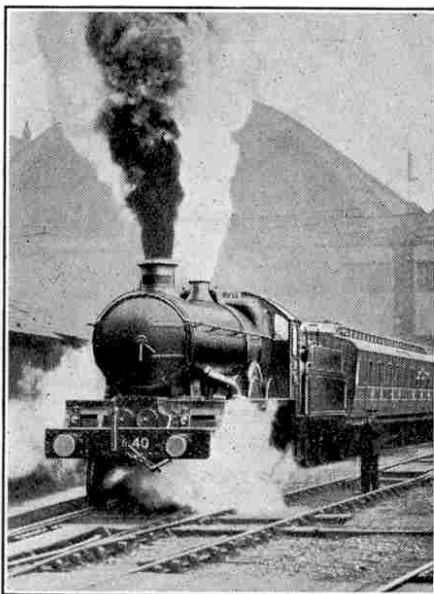

G.W.R. "*Pendennis Castle*" leaving King's Cross, with the 10-10 a.m. Leeds express

train into Exeter station on the 20th April—was in our hands as quickly as two days later, a very creditable performance, especially when we remember that the "snap" was taken by an amateur with a small hand camera.

"Castles" and "Pacifics" Compared

In view of the excellent performances put up by both locos under trial, the further particulars and dimensions which we append should provide interesting comparisons between the rival types.

In size, the L.N.E.R. "*Flying Scotsman*" class exceeds the G.W.R. "Castle" locos, since the latter rely on a small boiler with a high steam pressure, as opposed to the large boiler with a lower pressure of the L.N.E.R. Engines. Loco No. 4474 used in the trials weighs 30 tons more than its rival, while its tender carries, in addition to 8 tons of coal;

a water supply exceeding that of the "*Pendennis Castle*" by 1,500 gallons. Consequently the former is probably capable of a greater sustained effort, but as regards actual speed and power there seems little to choose between the two.

"No. 4474" belongs to the famous L.N.E.R. fleet of "Pacifics" (4-6-2). The loco is fitted with a superheater having a heating surface of 525 sq. ft., which, with the 168 boiler tubes and firebox, brings the total heating surface to 3,455 sq. ft. The size of its boiler may be imagined from the fact that during its run to Plymouth it consumed thirty gallons of water for every mile covered, and another 2,500 gallons were scooped into its tender whilst running, from the troughs between the rails.

The steam working pressure is 180 lbs. per square inch, and there are three cylinders, each 20" x 26", all driving the centre pair of coupled wheels. The diameter of the wheels of the leading bogie is 38", of the coupled drivers 80" and of the trailing wheels 44".

The boiler is 19' in length and has a maximum diameter of 6' 5", and the smokebox is 5' 11" in length by 6' in width. In working order the engine with tender weighs 148 tons 15 cwt., 60 tons of which represents the adhesive weight, since that is the load supported by the six driving wheels. At 85% of the boiler pressure the tractive effort equals 29,835 lbs.,

and therefore the ratio is said to be 4.5. This means that every 4½ lbs. of the adhesive weight represents 1 lb. tractive effort.

Details of "Castle" Locos

The G.W. "Castle" class numbers amongst its members one of the best-known locos in the world—the "*Caerphilly Castle*." The fame of this loco rests

(Continued on page 287)

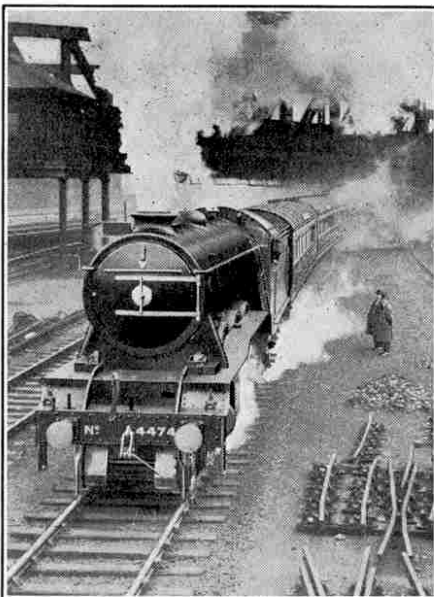

L.N.E.R. No. 4474 leaving Paddington with the Cornish-Riviera express

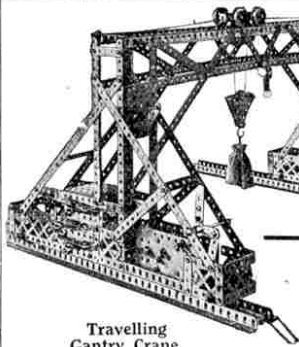

Travelling Gantry Crane

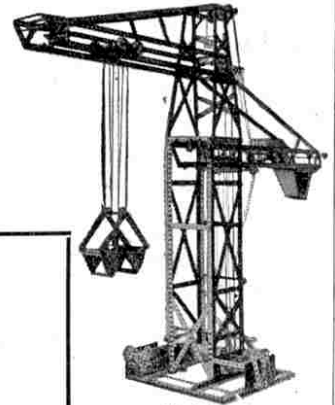

High-Speed Ship-Coaler

MECCANO

ENGINEERING FOR BOYS

Meccano this year is heaps more fun than it has ever been before. Many new parts have been added recently, and this, of course, means new and better models.

There is no limit to the number of models any boy can build with a Meccano Outfit. The hundreds shown in the Instruction Manuals are just suggestions and no boy ever stops when he has built them—he goes on building new models that he invents himself.

That's why Meccano is such splendid fun. The Crane you build to-day is a Tower to-morrow, a Motor Chassis the next day and so on. You can build a new model every day for years, if you wish! They will be real models, too, all sturdy and strong because they are built of steel. Meccano parts are exactly similar to the parts used by real engineers, only smaller. That's why Meccano Cranes lift and swing heavy loads, Meccano clocks keep perfect time, Meccano motor-cars run, and Meccano Looms weave real fabrics.

Meccano models are easy to build—you only require a spanner and screw-driver and these are provided in every Outfit.

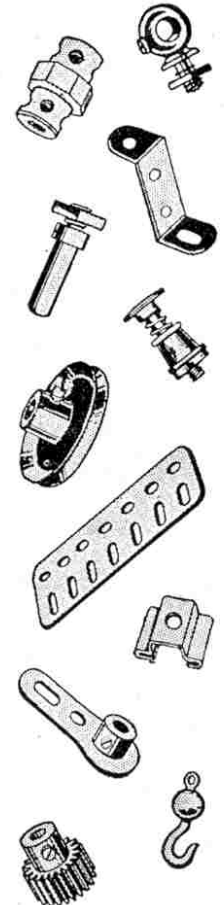
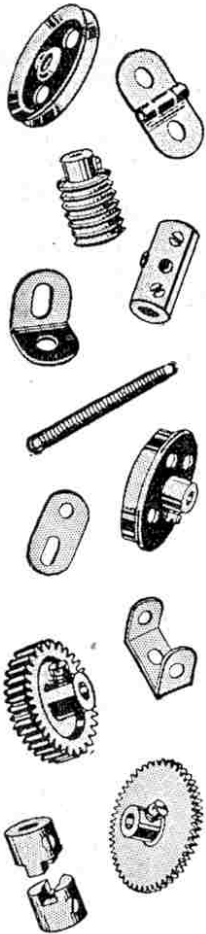

COMPLETE OUTFITS	
No. 00	3/6
No. 0	5/-
No. 1	8/6
No. 2	15/-
No. 3	22/6
No. 4	40/-
No. 5 (in well-made carton)	55/-
No. 5 (in superior oak cabinet with lock and key)	85/-
No. 6 (in well-made carton)	105/-
No. 6 (in superior oak cabinet with lock and key)	140/-
No. 7 (in superior oak cabinet with lock and key)	370/-

ACCESSORY OUTFITS	
No. 00a	1/6
No. 0a	4/-
No. 1a	7/6
No. 2a	8/6
No. 3a	18/6
No. 4a	15/-
No. 5a (in well-made carton)	50/-
No. 5a (in superior oak cabinet with lock and key)	80/-
No. 6a (in superior oak cabinet with lock and key)	210/-
Electrical Outfit	42/-

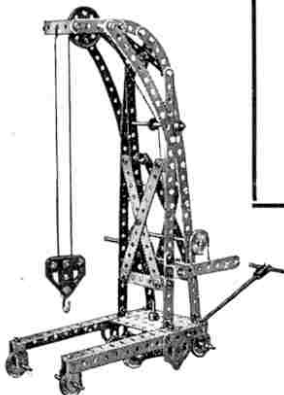

Platform Crane

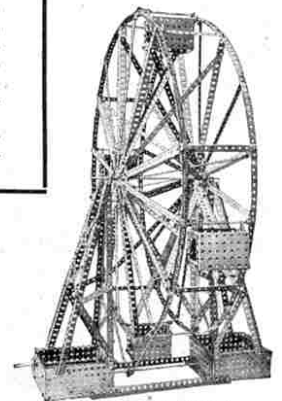
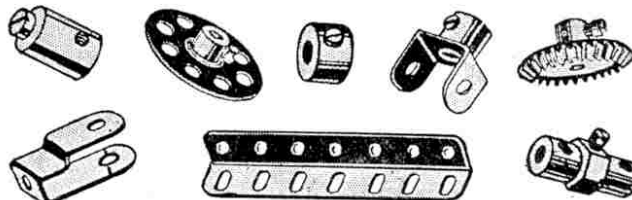

Big Wheel

A NEW MECCANO MODEL

Model No. 709. Stiff-Leg Derrick

MOST of our readers will probably recognise an old friend in the Meccano Stiff-Leg Derrick, but this model has been recently revised to such an extent, and consequently greatly improved in both appearance and operation, that we have decided to include it in these pages, under the "New Meccano Model" heading.

The Stiff-Leg Derrick is one of the most interesting models to build and is constructed on simple but carefully-planned lines. We venture to say that when completed the model will repay the study of anyone interested in engineering.

Scores of Derricks of this type may be seen every week in various districts in London and almost every other city and town in the country where reconstruction work is in progress. At any hour of the day people will be found gazing at these cranes, which are often perched aloft on great triangular wooden structures. The spectators are fascinated in watching the jib of the Derrick swing busily to and fro, hoisting girders or huge blocks of stone, and adding every few minutes to the strength of the building that is rising around it. Perhaps one of the causes that hold the little crowd on the pavement spellbound is their

admiration for the builders who nonchalantly proceed with their tasks around the crane, as though quite unaware that at times nothing but a plank of wood is between them and the ground, hundreds of feet below.

A close inspection of a Stiff-Leg Derrick shows that the strongest parts of the supporting structure are at the base of the jib—where it must withstand the compressive force exerted by the weight, or thrust, of the jib—and at the outer ends of the tie-members supporting the upper pivot of the rotating jib frame. In the latter case the force to be overcome is that of tension, exerted by the pull of the jib and its load.

Construction of the Model

The base of the Meccano Model is formed of 18½" Angle Girders (1) bolted to a 24½" Girder (2) and held rigid by a 12½" Girder (2A). The side members (3) are constructed from 24½" Angle Girders extended at their lower ends by 2½" Girders overlapped three holes. 2½" Strips (6, Fig. A) bolted to the tops of the Girders (3)

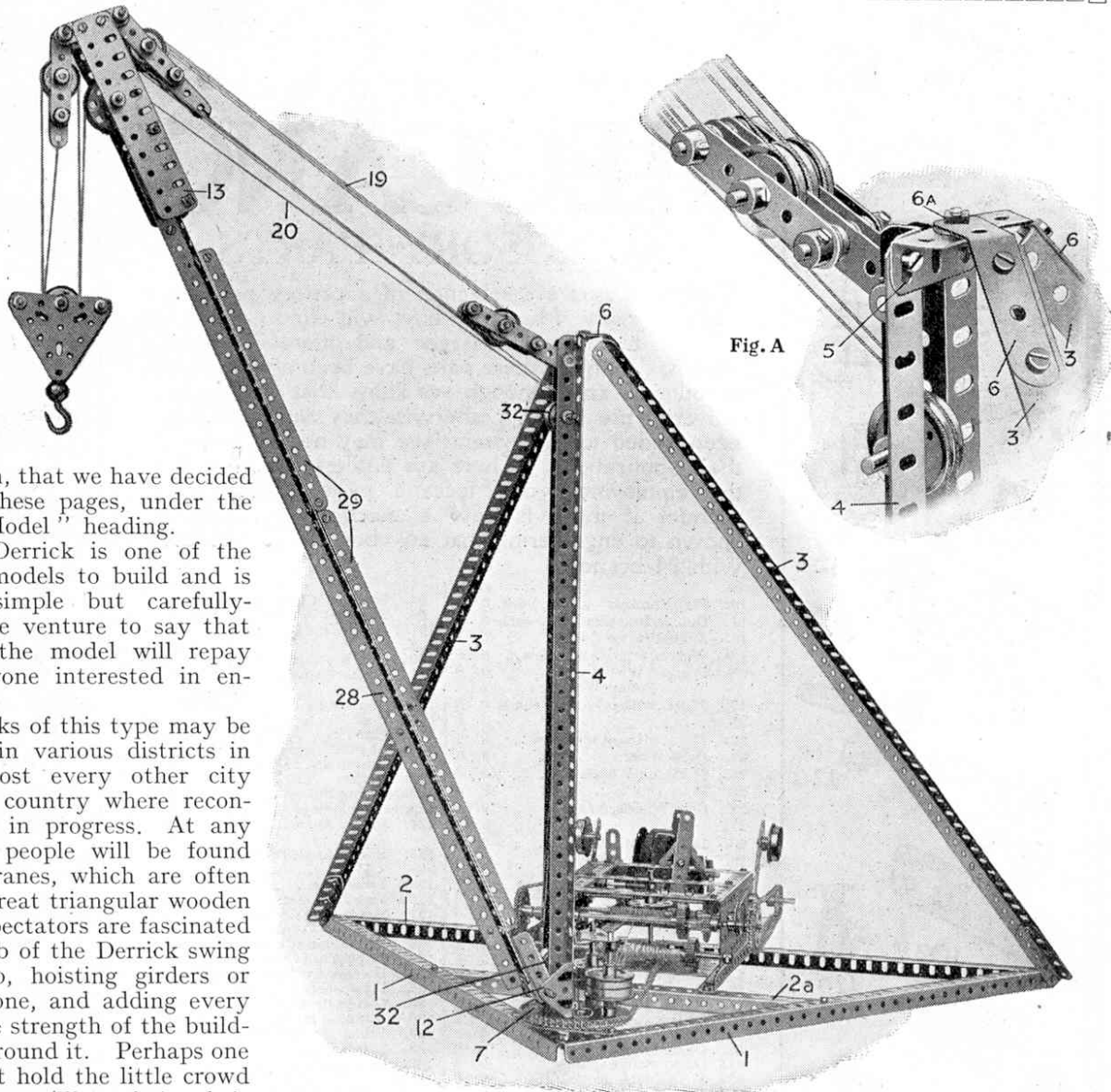

Fig. A

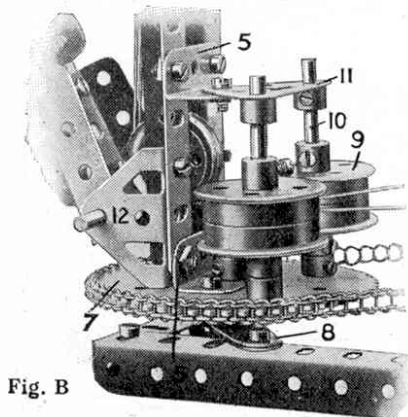
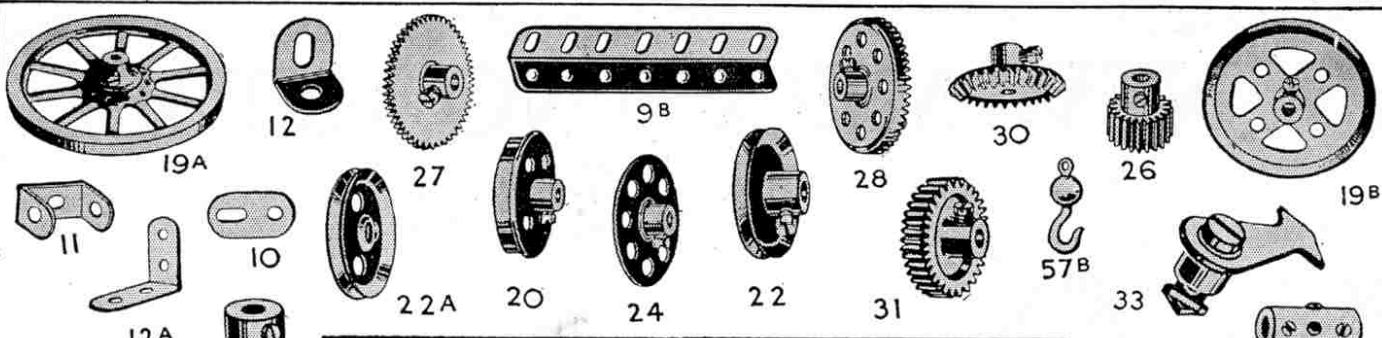

Fig. B



MECCANO

ACCESSORY PARTS

WE illustrate a selection of accessory parts that every Meccano boy will find useful in building the larger and more interesting models. Many of these parts have been only recently introduced, and although we know that they have a universal use (were it otherwise they would not have been added to the system) we may not yet know all their applications. There are endless possibilities in the employment of Meccano parts; indeed, we wonder if there is now a mechanical movement known to engineering that any boy cannot duplicate with Meccano.

	s.	d.		s.	d.
10. Flat Brackets ...	1/2 doz.	0 2	94. Sprocket Chain per length	0 6	
11. Double Brackets ...	each	0 1	96. Sprocket Wheels, 1" each	0 3	
12a. Angle Brackets, 1" x 1"	"	0 1	101. Healds, for Looms ...	doz.	0 9
19A. Wheels, 3", with set screw	"	0 8	108. Architraves ...	each	0 2
20. Flanged Wheels	"	0 6	109. Face Plates, 2 1/2" diam.	"	0 4
Pulley Wheels:			113. Girder Frames ...	"	0 2
19B. 3" dia., with set screw	each	0 8	114. Hinges ...	per pair	0 4
22. 1" " "	"	0 4	115. Threaded Pins ...	each	0 2
22A. 1" " without set screw	"	0 2	116. Fork Pieces ...	"	0 3
24. Bush Wheels ...	"	0 6	118. Hub Discs, 5 1/2" diam.	"	1 3
25. 3/4" Pinion Wheels ...	"	0 6	119. Channel Segments (8 to circle), 1 1/2" diam.	"	0 4
26. 1/2" " "	"	0 4	120. Buffers ...	"	0 2
27. Gear Wheels, 50 teeth	"	0 9	120A. Spring Buffers ...	per pair	0 8
27A. " " 57	"	0 9	123. Cone Pulleys ...	each	1 3
28. 1 1/2" Contrate Wheels ...	"	0 9	124. Revsd. Angle Brackets, 1" ...	1/2 doz.	0 10
29. 3/4" " "	"	0 6	125. Revsd. Angle Brackets, 1 1/2" ...	"	0 6
30. Bevel Gears ...	"	0 10	126. Trunnions ...	each	0 3
31. 1" Gear Wheels, 38 teeth	"	1 0	126A. Flat Trunnions ...	"	0 2
32. Worm Wheels ...	"	0 6	127. Simple Bell Cranks ...	"	0 3
33. Pawls (complete) ...	"	0 4	128. Boss Bell Cranks ...	"	0 4
43. Springs ...	"	0 2	129. Rack Segments, 3" diam.	"	0 6
44. Cranked Bent Strips ...	"	0 1	130. Triple Throw Eccentrics ...	1 3	
45. Double Bent Strips ...	"	0 1	131. Dredger Buckets ...	"	0 2
50. Eye Pieces ...	"	0 2	132. Flywheels, 2 1/2" diam.	"	2 3
57B. Hooks (loaded) ...	"	0 5	133. Corner Brackets ...	"	0 3
59. Collars and Set Screws	"	0 2	136. Handrail Supports ...	"	0 3
62. Cranks ...	"	0 3	137. Wheel Flanges ...	"	0 4
63. Couplings ...	"	0 6	138. Ship's Funnels ...	"	0 4
63A. Octagonal Couplings	"	0 8	139. Flanged Brackets, Right, ...	"	0 2
63B. Strip Couplings ...	"	0 8	139A. " Left, ...	"	0 2
63C. Threaded Couplings ...	"	0 6	140. Universal Couplings ...	"	0 9
64. Threaded Bosses ...	"	0 2	144. Dog Clutch ...	"	0 6

You may obtain Meccano Parts from your Dealer

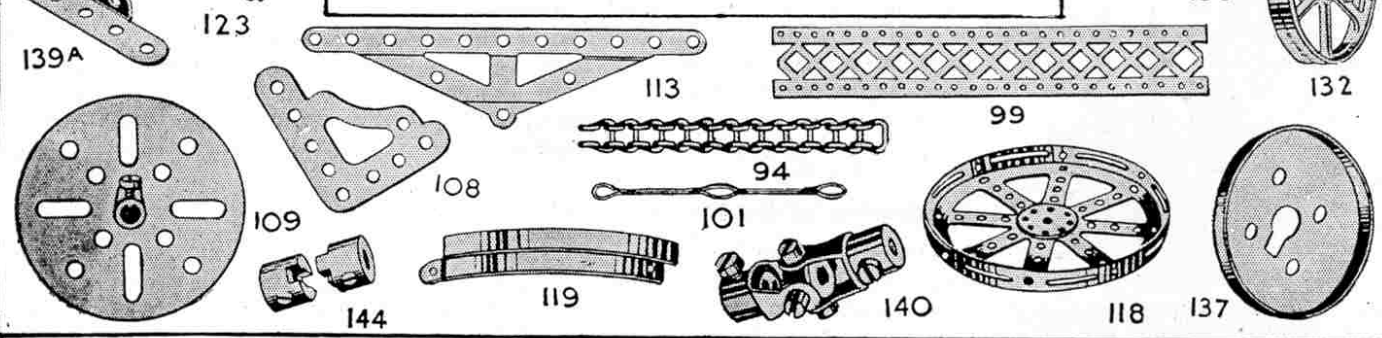

are slightly bent, as shown, and meeting together form a bearing for the bolt (6A), about which the upright member (4) pivots. The latter consists of 18½" Angle Girders, bolted together at each extremity by 1½" Girders (5), while a third 1½" Girder is bolted in the fifth holes from their lower ends (Fig. B). The lowest of these 1½" Girders is secured to a 3" Sprocket Wheel (7), which forms the swivelling base of the jib. The pivot is a 1½" Rod passed through the centre hole of the 1½" Girder and through the boss of the Sprocket Wheel and carried in a bearing (8) built up from two 2½" Strips bolted across the base Girders (1). Two Collars should be placed on this Rod, one above the Sprocket (7) and one below the Strips (8).

Two Flanged Wheels butted together forming guide pulleys (9) are carried on 2½" Rods (10), the upper ends of which are journalled in a Corner Bracket (11), secured to the 1½" Girder (5), while their lower ends engage holes in the Sprocket (7).

The jib is built up from two 24½" Angle Girders (28) bolted together in the form of a T and strengthened by pairs of 12½" and 7½" Angle Girders (29) similarly bolted together and secured along the upper sides of the Girders (28). A 2½" Rod, about which the jib pivots, is journalled through Trunnions (12, Fig. B) and through the end holes of 2" Girders bolted in the first and third holes from the end of the 24½" Girders (28). The head of the jib (Fig. D) is formed by two 5½" Flat Girders (13) secured to 2½" Angle Girders, bolted in the first and fourth holes of the Girders (28).

The Three Motions

The construction of the various pulley-blocks (Figs. A & D) may be followed from the illustrations, but care should be taken in spacing the strips with Washers in order to allow for free-running of the pulleys, or "sheaves."

The Motor and Gear-box are carried on 12½" Angle Girders (15, Fig. C) secured to the base Girder (2) and the cross stay Girder (2A); a 5½" x 3½" Flat Plate forms a base for the Motor and large Flanged Plates form the sides of the Gear-box.

There are three motions in the Crane, namely, swinging and luffing the jib, and hoisting—all of which are driven from the motor and controlled by suitable levers.

The jib is raised or lowered by means of the cord (19) winding on the Rod (18, Fig. C). The drive from the

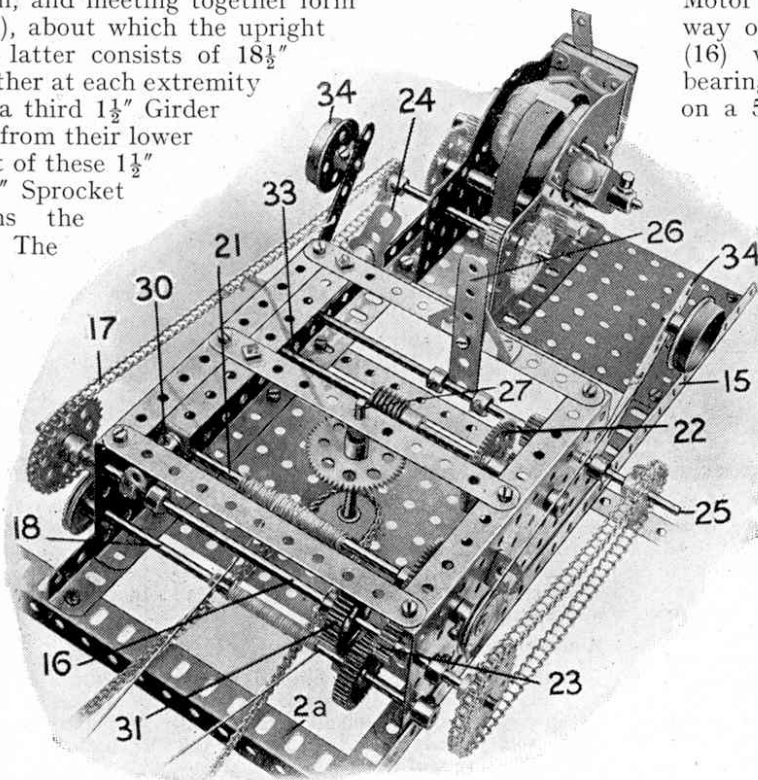

Fig. C

Motor is led to this Rod (18) by way of chain gear (17) and Rod (16) which is slideable in its bearings. A Crank (24) is mounted on a 5" Rod journalled in a 4½" Double Angle Strip and carrying a Coupling (30); a 1" Rod secured to the latter engages between two Collars on the Rod (16). On pulling the Crank (24) over to the right, the Rod (16) slides in its bearings, so bringing the 1" Gear Wheel (31) into engagement with a similar Gear secured to the shaft (18). This operates the cord (19), which, after passing round 1" guide pulleys (32) in the vertical member (4), is led round one of the sheaves of the pulley block pivoted at the rear of the jib-head, thence back again round one of the three pulleys situated at the head of the upright (4, Fig. A), and so on round all the six pulleys; finally its end is secured to the "tail" of the pulley block at the jib-head.

Rotating and Hoisting

The hoisting-block is operated by the cord (20) winding on a rod (21, Fig. C) which also carries a 57-toothed Gear Wheel. On moving the lever (24) over to the right, a ½" Pinion (23) is brought into mesh with this Gear Wheel, so connecting the hoisting mechanism with the drive from the Motor. The cord (20) is led over the pulleys in the vertical member in a similar manner to the cord (19) before passing over a 1½" Pulley in the jib-head; it next engages alternately the sheaves of the hoisting-block and of the second fixed block in the jib-head, being finally secured to the latter.

When the lever (24) is in a central position both the gears (31 and 23) are out of engagement; the Motor therefore is allowed to run freely.

The rotation of the jib is effected as follows: a Rod (25) driven by Sprocket Chain from the Rod (16) may be moved to and fro in its bearings on operation of a lever (26), and this movement is employed to engage or disengage a ½" Pinion with a 57-toothed Gear Wheel (22) on a secondary shaft (33). The latter carries a Worm Wheel gearing with another 57-toothed Gear Wheel on a vertical Rod (27) and a 1" Sprocket Wheel on this Rod rotates by means of a Sprocket Chain the 3" Sprocket

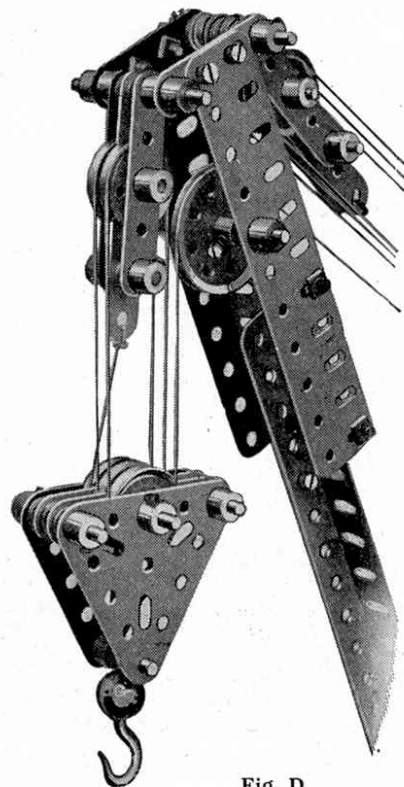

Fig. D

(Continued on page 320)



The Story of Metals

I. LEAD.

AS in the case of most of the other metals, the early history of lead is wrapped in mystery. The metal has certainly been in use from a very remote period, but it is probable that its discovery occurred some time after that of copper. There is evidence that the Assyrians, Egyptians, and other ancient peoples used the metal, and it is referred to in the Bible by Moses:—"Only the gold and the silver, the brass, the iron, the tin and the lead—everything that may abide the fire ye shall make it go through the fire and it shall be clean."

Lead was mined in large quantities by the Greeks and Romans. The mines of Laurium in Attica, which were reopened by a French company in 1863, were flourishing in the fifth century B.C. Large amounts of ore were taken by the Romans from mines in the south-east of Spain which were opened in the third century B.C. by Hannibal. We know also that the Romans carried on extensive mining operations along the Rhine and in various parts of England.

The old alchemists were keenly interested in lead. They regarded it as the oldest of all metals and named it after Saturn, the father of the Gods. They used lead very largely as the basis of their efforts to bring about the transmutation of metals, hoping to discover the "Philosopher's Stone" which, by a touch, should transform the base metal into gold. Unfortunately for their hopes the "Philosopher's Stone" was never discovered, although modern chemical investigations show that these ancient experimenters were nearer success than they realised.

Lead Ores

Lead is found in various parts of the world. The United States produce about a third of the total output, and next in importance come Spain, Germany, Mexico, and Australia. A considerable amount of the metal is produced also in Burmah.

The most important lead ore is "Galena," crystals of which are very familiar to-day as used

in detectors for wireless sets. Galena is a combination of lead and sulphur. The only other ore of real commercial importance is "Cerussite" or natural lead carbonate.

Mining, Crushing and Concentrating

In the United States the largest amount of lead is mined in Missouri. The ore was discovered about 1700 and first worked some twenty years later. In present-day operations a vein of the metal is sought for by boring into the earth and bringing up samples of the rock. When the vein is struck, shafts are sunk from which tunnels are driven in various directions, following the course of the vein.

The ore-bearing rock is brought to the surface in big lumps, which are passed

through a series of revolving crushers, emerging as fine as sand.

The crushed material is then spread out on a sort of table that moves backward and forward with a quick jerking motion, causing the material to be impelled forward. The table has a slight tilt downward and is fitted lengthways with a series of low ledges or "riffles." The material is fed along the table with water, and on reaching the riffles the lighter particles, which contain practically no lead, are pushed over and so pass off the table at the side. The heavier lead-bearing particles are not able to surmount the riffles and so they work gradually down the table to the end. This process, which is called "concentrating," removes the greater part of the worthless material, and the material that remains contains a very high percentage of metal.

Smelting in the Blast Furnace

The concentrated ore is now ready for the smelter. In some cases the sulphur in galena can be separated from the lead by causing it to combine with oxygen. This is effected by treating the ore in an ore-hearth, which consists essentially of a small low fire-place surrounded by three walls, and having a tuyere at the back.

Frequently, however, the ore contains other impurities that cannot be eliminated in this manner, and smelting in a blast furnace is necessary. The ore is first roasted to remove the greater part of the sulphur and is then fed in at the top of the blast furnace along with the fuel, generally coke, and the "fluxing" materials, which are usually sand, iron ore and limestone. An intense heat is obtained by an air blast in exactly the same manner as in the smelting of iron. When the proper moment arrives the lead is drawn off at the bottom of the furnace.

Refining

The lead produced in the blast furnace contains small quantities of silver, copper, antimony and other metals,

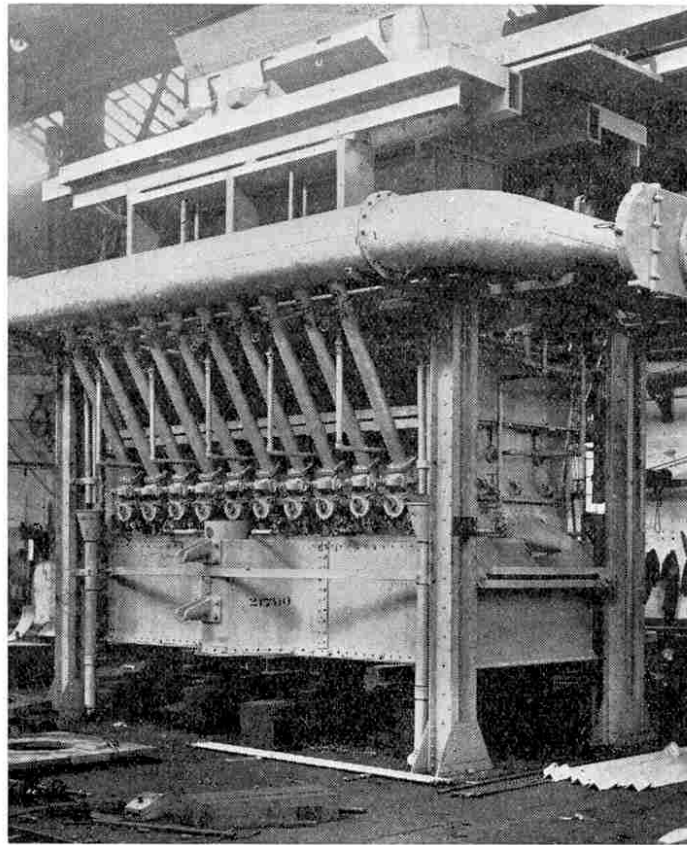

Courtesy]

[Fraser & Chalmers' Engineering Works

Lead Smelting Furnace

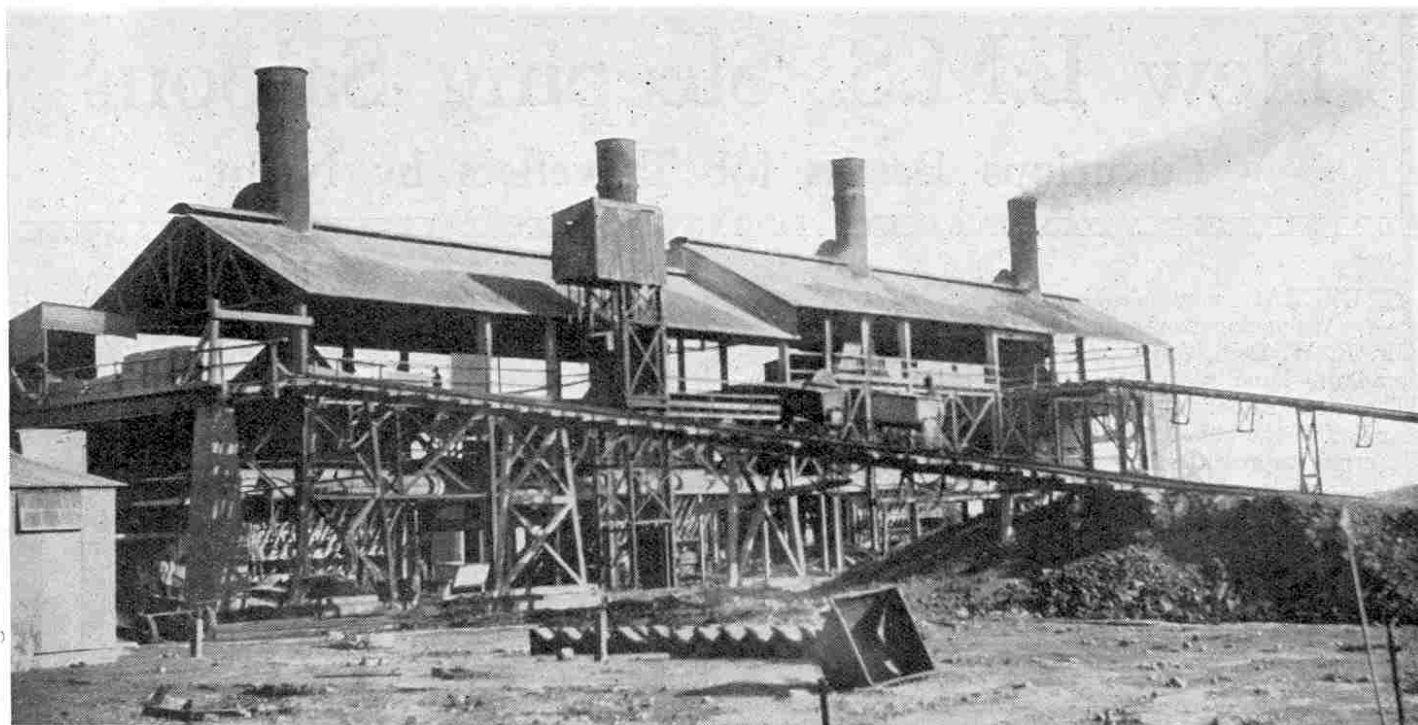

Courtesy]

South African Smelting Plant

[Fraser & Chalmers' Engineering Works

and these must be removed by some process of refining.

The most important impurity in lead is silver, and most lead ores contain sufficient silver to make its recovery profitable. The removal of the silver is known as "desilverization," and it is most often effected by what is known as the "Parkes" process.

The first step is to remove the copper by a process called "liquation." This process depends upon the fact that copper solidifies at a higher temperature than lead. The molten lead is gradually reduced in temperature until the point is reached at which the copper compounds solidify, and these are then skimmed out. The lead, still molten, is now drawn off into a reverberatory furnace to undergo the process known as "softening." It still contains a certain amount of copper, but what is more important it contains also arsenic and antimony, which are very harmful even in small quantities. In the reverberatory furnace the lead is raised to a very high temperature and is thoroughly stirred. The arsenic and antimony present thus come in contact with the current of air in the furnace and are oxidised and skimmed off as dross.

Recovery of Silver and Gold

At this stage the lead still contains its silver and also certain quantities of gold and copper, and in order to separate the metal from these impurities it is run off into cast iron vessels known as "kettles." Small quantities of zinc are now thoroughly stirred into the molten lead, the exact amount of zinc added being determined by the amount of silver and gold in the lead. The zinc unites with the silver and gold to form an alloy which, being lighter than the lead, comes to the surface. The temperature of the molten mass is then lowered and as the alloy solidifies before the lead it is easily removed. This alloy contains practically all the silver, gold and copper and some of the zinc, and the lead is now pure except for a small

quantity of zinc which is removed by further treatment in a reverberatory furnace. The refined lead is then cast into "pigs" weighing from 70 lb. to 100 lb. each.

Another method of desilverization, formerly in extensive use, is the "Pattinson" process. This process is based upon the fact that if lead is melted and then slowly cooled, the crystals that separate out are much poorer in silver than the original lead, while the liquid remainder is correspondingly richer in silver.

An Interesting Process

In its original form the Pattinson process is carried out in a set of from eight to fifteen cast iron spherical "kettles," each holding from six to fifteen tons of lead. The kettles are built close together in a row and each has a separate fire-place. The lead to be treated is placed in the central kettle and melted down, and then the fire below is withdrawn and transferred to a neighbouring kettle, the molten mass being continuously stirred while it slowly cools. Crystals separate out and are removed by means of a long-handled skimmer and transferred to the next kettle on the right. This process is continued until two-thirds of the whole contents of the central kettle have been removed in the form of crystals. The liquid remainder is then ladled into the next kettle on the left.

The kettle on the right is now two-thirds full of crystals, and to it is added one-third of lead containing the same proportion of silver. The kettle on the left is one-third full of molten lead, and to it is added two-thirds of lead containing a corresponding amount of silver. These two kettles are now heated, and then cooling, crystallizing and ladling out are carried on just as in the case of the original kettle. The latter thus receives crystals from the kettle on the left and liquid lead from the kettle on the right. The process is continued, with the final result that the amount of silver decreases in the kettles to the right up to

the last one, while it increases correspondingly in the kettles to the left. In this manner a large amount of lead low in silver is produced, together with a small amount of lead very rich in silver.

There is also a variation of the Pattinson process in which only two melting pots and a crystallizer are used. The stirring is done by means of a jet of steam, and instead of ladling out the crystals the liquid lead is drawn off.

In some cases an electrolytic method of desilverizing is employed. The anodes consist of the lead to be refined, while the cathodes are made of pure lead. A special lead solution, is used as the electrolyte, and as the current passes pure lead is taken from the anodes and deposited upon the already pure cathodes.

"Cupellation"

The amount of gold and silver in lead may be determined by an interesting process known as "cupellation." The sample of lead to be tested is placed in a small cup or "cupel" made of bone-ash, which is a very porous substance. The cup is then heated to a very high temperature, which has the effect of oxidizing the lead, but not the silver and gold. The oxidized lead either sinks into the pores of the cup or passes away as fumes, while the silver and gold remain in the form of a tiny button. This button is weighed, and its two metals are then separated by treating it with nitric acid so as to change the metallic silver into silver nitrate. The gold remaining is then weighed, and the difference between its weight and that of the whole button gives the weight of the silver.

Lead Pipes Laid 1,800 Years Ago

Lead is bluish-grey in colour, and a freshly cut surface shows a bright lustre which quickly tarnishes on exposure to air. It is so soft that it can be easily scratched with the finger nail and it readily marks paper with a grey streak.

(Continued on page 287)

New L.M.S. Sleeping Saloons

Luxurious Berths for Travellers by Night

SEVERAL new sleeping saloons—built at the Wolverton works of the L.M.S. to the design of Mr. R. W. Reid, C.B.E., Carriage and Wagon Superintendent—have recently been placed in commission. The new saloons are in general arrangement very similar to the old standard L.N.W.R. type, but various internal improvements have been made, adding many luxurious touches, which will, no doubt, be highly appreciated by passengers travelling at night.

The principal dimensions of the saloons are:—Length of Vehicle over Buffers, 71 ft. 8 in. Length of Vehicle over Body, 68 ft. 1 in. Width of Waist, 9 ft. 0 in.

Reducing Vibration

Special attention has been given to the springing, to ensure smooth riding. Each saloon is mounted on two six-wheeled bogies, and is supported on an all-steel underframe with fixed truss.

To reduce vibration and noise to a minimum, india-rubber body blocks are fixed between the body and the underframe, and hair felt is inserted between the double floors.

The coaches are equipped with vacuum brakes, electric lighting and steam heating. There is also electric communication between each berth and the attendant, the control switches for lighting being placed in the latter's compartment.

Each coach contains twelve single berths and an attendant's compartment and lavatory, with a vestibule entrance at each end. Communicating doors are placed between six of the single berths so that, if necessary, two single berths may be converted to a double berth.

Interior Decorations

The structural framing of the saloon bodies is of oak and teak, panelled with canvassed and blocked Honduras mahogany. The interior finishing of the berths and corridor consists of mahogany framing and finely veneered mahogany panelling. The ceilings and all above the cornice moulding

throughout the saloon are finished with three-ply birch, painted and enamelled white.

White-corded net racks, supported on brass brackets finished oxidised silver, are fixed above the beds. These racks have been designed to give the maximum storage for light articles.

In each berth a self-contained mahogany lavatory cabinet is arranged, and in the upper part of the cabinet are fixed a folding table and a folding wash basin, with hot and cold water. The whole of the fittings are silver plated.

Above the cabinet a mirror, a brush and comb rack, a water-bottle, a glass holder and an electric lamp are fixed. The metal fittings are neatly designed and finished in oxidised silver.

Rolling Shutter Excludes Draughts

A folding mahogany table is fitted on one side of the cabinet in the berths, and accommodates a tea tray.

A drop light, with perforated sheet copper in the top, is arranged on the coach side of the berth. A noteworthy feature is a rolling shutter arranged over these drop lights. In the "up" position this shutter is hidden behind a hood, but when the shutter is down absolute privacy and a general appearance of warmth and cosiness are obtained. This shutter does away with blinds and curtains and excludes all draughts.

Vertical Westinghouse five-column radiators are fixed in front of the side windows, and arranged so that the passenger can control the warmth of the berth either at the radiator or when in bed.

The berths are ventilated with hemispherical vents in the roof, drop light grilles fixed in the corridor partition above the cornice, and by small electrically-driven fans.

Passengers Control Lamps

Each berth is illuminated by a lamp over the mirror and one over the head of the bed. The latter is fitted with a satin-finished globe,



Photo courtesy]

[L.M.S.]

Corridor of New L.M.S. Sleeping Saloon

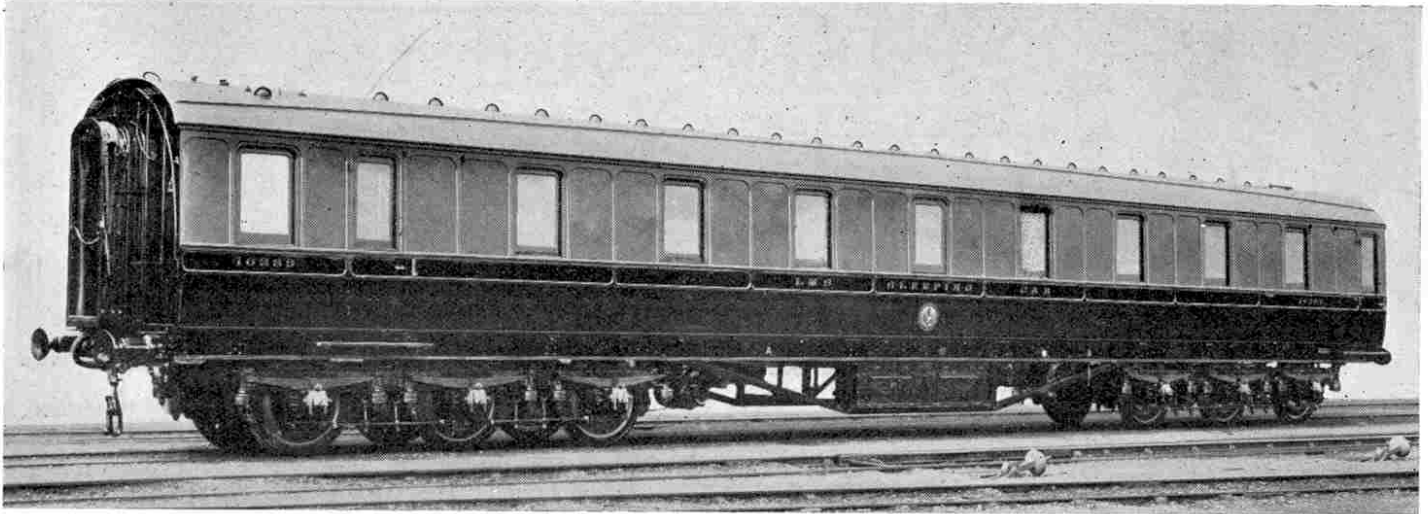

Photo courtesy]

One of the L.M.S. First Class Sleeping Saloons, built for the London-Scotland Service

[L.M.S.]

for use as an ordinary lamp, and a small blue glass globe enclosing a night lamp. The switches controlling the lamps are fixed near the head of the bed so that each passenger may regulate the amount of light to suit his own convenience.

The floors of the berths are covered with inlaid linoleum with loose rugs on the top. The windows in the corridors are all of the drop type and a postal box and a fire extinguisher are placed in convenient positions.

Sleeping saloons are attached to all the night express trains of the London Midland and Scottish Railway working between London and Stranraer, Edinburgh, Glasgow, Perth, Dundee, Aberdeen, Oban and Inverness, and there is little doubt that the new vehicles will be greatly appreciated by passengers making the night journey to Scotland by way of the West Coast and Midland routes. Ten of these luxurious saloons have been put into service and we understand that it is not intended to build any more at present.

Locomotive Exchanges

Some Interesting Results of Railway Grouping

By Gerald W. Spink

ONE of the most interesting sequels to the concentration of British railways in four great groups is the series of locomotive exchanges thereby brought about. Even before the railways were grouped interchange of engines was by no means unknown, but since the grouping the number of exchanges has increased tremendously.

Let us start from the South, working northwards, and consider some of the new developments. The "Harrogate Pullman Express" runs non-stop as far as Leeds, on the metals of the late Great Northern Railway, but the engine used is generally one belonging to the late Great Central Railway, and among such locomotives noted on this train have been "Lloyd George," "Earl Haig," and "Lord Faringdon," all veritable giants. Then the "Sheffield Pullman," which is really a Great Central train, though it starts from King's Cross instead of Marylebone by special arrangement, is frequently hauled by a G.N. "Atlantic" engine. Again, between London and Birmingham, on the late L.N.W.R., Midland engines are working frequently. The appearance of a Midland engine at Euston must have seemed very strange at first!

Further north the L.N.W. engines have been running in competition with Midland locomotives on the difficult section between Leeds and Carlisle, and it is to the credit of both companies that each type of engine showed great merit. Between Crewe and Carlisle, on the L.N.W.R., Lancashire and Yorkshire engines

have been working some of the heavy England-Scotland trains with very successful results.

On the East Coast Route, North Eastern engines frequently make their appearance as far south as London itself, and until recently a North Eastern locomotive was responsible for performing a non-stop run of over 100 miles between Grantham (G.N.R.) and Darlington (N.E.R.), two towns which, for the first time in railway history, have received uninterrupted rail communication. Formerly G.N. locomotives were never permitted north of York (with the exception of one which occasionally went as far as Thirsk by special permission), but now fifteen of the new "Pacifics" of G.N. design—like the one exhibited at Wembley—are actually stationed at Newcastle, for hauling heavy trains to and from Edinburgh. Again, North British "Atlantics" have been working as far south as Newcastle on the main line, a thing unknown before 1921.

To balance this, North Eastern engines have taken their turns on the N.B. line between Edinburgh and Glasgow. Some new engines built to the designs of the former Great Central Railway are now doing the bulk of the heavy fast traffic between the two great Scottish towns, and a few of the same class are also running to Perth. It is indeed a far cry from Marylebone to Perth, yet in the year 1925 it is possible to see a G.C. engine at Perth. The very thought of such an occurrence would have been considered ridiculous ten years ago!

(Continued on page 281)



Dick's visit to MECCANOLAND

Where dwell the Happy Boys

(Continued)

"NOW," said Mr. Hornby, "you are beginning to see why boys become so enthusiastic over Meccano, and why, after all these years, there is no waning in my own enthusiasm. It is always teaching me something new, educating me and making me a better man and a better citizen."

What Meccano Taught Mr. Hornby

"It has taught me, and is going to teach you, the principles of weaving. Through the Meccanograph it has taught me the fascinations of design-making. It has taught me how a motor car gear box operates and how that intricate piece of mechanism, the differential, plays its important part in every motor car on the road to-day.

"Through Meccano I have learned the secret of how clocks keep time; how coal and ore are raised from the mines; how rope and twine are manufactured; how a marine engine works, and a host of other things—in fact it teaches me something new every day.

The Worth of a Meccano Boy

"I believe a keen Meccano boy has twice as much useful knowledge as any other boy. He is more likely to get a good job, and is more likely to succeed in any work he undertakes. He is a thinker, accustomed to take the initiative, always trying new schemes and inventions; and because he is nimble and dexterous with his fingers, he will often get through a job before another boy has started to think about it.

"A Meccano boy knows what accuracy and thoroughness mean, through handling accurate parts that have to be put together accurately. He learns to take great care of all the parts, and to keep them in an orderly manner; and, mind you, all these habits of orderliness, accuracy, and thoroughness that he acquires in his play-hours become fixed habits with him all through his life, and vitally affect his career.

"One of the best-known men in this country once told me that he bought Meccano Outfits for his boys because he believed Meccano would be worth £10,000 to them when they became men."

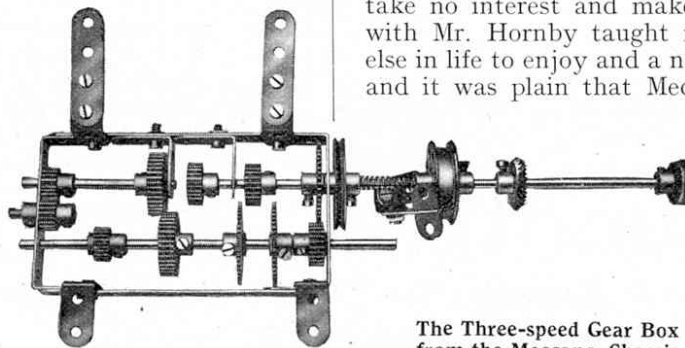

The Three-speed Gear Box
from the Meccano Chassis

While Mr. Hornby was talking, my thoughts turned to Dick's future. I could see many years of Meccano happiness and fun before him, and I could clearly see something even better than that. I could see him growing up into an alert, thinking man, not afraid to experiment and break new ground; with thoughts and ideas well ordered, skilled with his hands, and with a knowledge of machines and mechanical movements such as few but Meccano boys acquire.

Dick had worried me for some time past to get him a Meccano Outfit, but I had been foolish enough to take no interest and make no investigation. My talk with Mr. Hornby taught me that here was something else in life to enjoy and a new duty to perform, however, and it was plain that Meccano was going to be "one of the family" in future.

"If you can wrench Dick away from the Loom," said Mr. Hornby, laughing, "I'll tell you one or two things about the business side of Meccano."

Dick, however, was unwrenchable! He seemed to have forgotten that Meccano made other models as well as Looms, or that there was anything else in life except weaving fancy-coloured materials; so we had to leave him to it.

Running a World-Wide Business

"Running a world-wide business is not easy," said Mr. Hornby, "but it is extremely interesting! Every month I receive letters from boys in nearly every town in every civilised country in the world, and if I myself could reply to each one in his own language I should be a linguistic wonder. But we do reply to them in their own language—our foreign correspondents take charge of that. We see that every letter is replied to and that all the little difficulties are straightened out.

"You might say that Meccano is an international toy. It talks boy-language in any country, and is at home anywhere. All our instruction books, catalogues and leaflets describing Meccano are printed in 16 different languages, even including Chinese! The translation of this Manual into Chinese was about the most difficult linguistic problem we have had to tackle, but we were fortunate enough to secure the services of an educated Chinese who is not only a perfect Chinese and English scholar but also a skilled engineer.



The Meccano Manual in Chinese

"Here is a copy of the Chinese Manual," continued Mr. Hornby, handing one over to me. "I don't think you will find any mistakes in it," he said, with a twinkle in his eye, "but if you do I hope you will point them out." I gave him my word of honour that I would!

"Some day I should like to take you and Dick over our factory and show you all the various Meccano parts being made."

At this Dick was all ears, and left the Loom immediately to join in the conversation.

"How about going over now; couldn't we start at once?"

Mr. Hornby laughed at the boy's eagerness. "No, Dick," he said, "I don't think we could fix it up on such short notice. You will require to spend at least a whole day if you are to see all the different processes. Better leave it for your father and me to arrange."

"We take as great an interest in our employees as we do in Meccano boys, and we see that they work under first-rate conditions. Take, for instance, the Packing Department, where all the Meccano parts are packed into the Outfits. This room covers an area of over 26,350 square feet. There is not a finer or healthier workroom anywhere, and all the other departments are just as good."

"Our people appreciate the thought and care we devote to their welfare, and there is no more skilful or more efficient staff of men and girls in any factory in the world. We use high-grade machines only—the best the world produces. They are all operated at high speed and afford us the utmost limit of rapid production."

"When I tell you that in a year we manufacture over 40 millions each of the little nuts and bolts that every Meccano boy uses and knows so well, and that every nut and bolt must be separately tested and put together by hand in order to ensure accuracy in accordance with our general guarantee, you will realise that there is no time to be lost if Meccano boys are not to be kept waiting!"

The Big Meccano Factory

"The Meccano factory is the biggest factory in the world for the production of a single toy, and we are extending our business so rapidly that in a very short time it will be double its present size. We make also the Hornby Clockwork Trains, and this side of the business, which is growing very rapidly, has a story of its own that some day I may tell you."

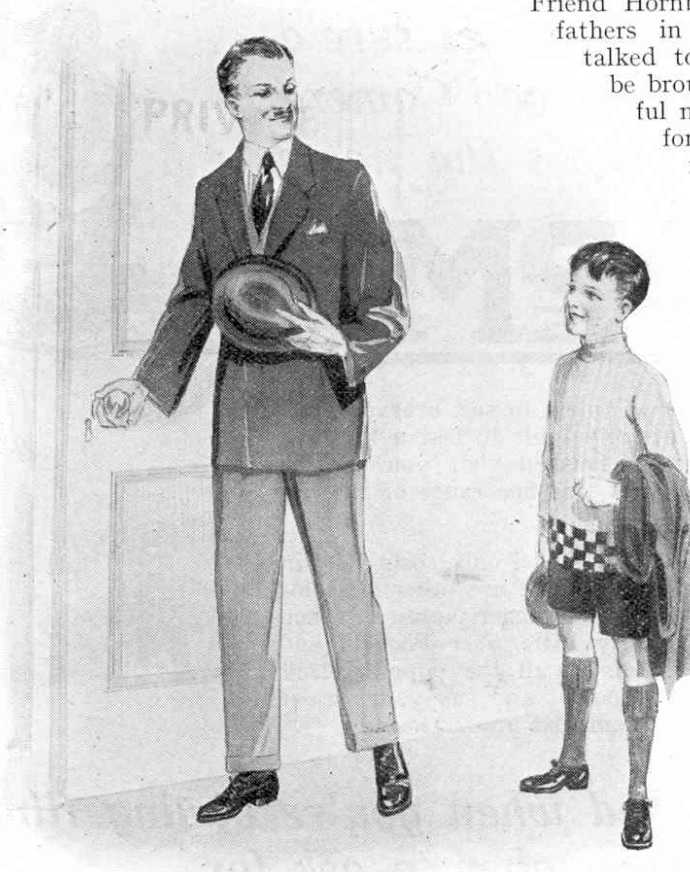

Dick and I left Mr. Hornby's Office reluctantly

Dick and I left Mr. Hornby's office reluctantly. We lingered again in the model-room as we passed through it, and said to each other what a delight it would be if we could take home an armful of the models that gleamed like silver in the sunshine that flooded the room. As we walked along the street we talked of Meccano reverently, as of a new and wonderful friend who had come into our lives, never to leave us, to be our companion and source of joy for many a long evening to come.

Friend Hornby! If you could talk to all fathers in this great country as you talked to me; if only parents could be brought to realise what a wonderful medium they have in your toy for developing and strengthening the minds of their children—for bringing out initiative and inventiveness; for filling their brains with keen, ambitious and wholesome thoughts—what a nation of supermen our future rulers and workers would be.

THE END.

Exchange of Locos—

(Continued from page 279)

Caledonian Locos come South

Caledonian engines are now often to be seen on the metals of the G. & S.W.R., all the more so because certain Euston-Scotland trains are diverted from the Caledonian route between Carlisle and the north, and run into Glasgow via Dumfries and Kilmarnock, quite an interesting innovation! This may have happened very occasionally in pre-group days when some accident on the one line made diversion of traffic necessary if

delay to passengers was to be avoided. Some Midland engines are to be sent for work in Scotland, and during the competition between L.N.W. & Midland locomotives (between Leeds and Carlisle) to which reference has been made, a Caledonian engine also took part. Leeds people must have been surprised to see a blue Caledonian engine so far south, though it is quite possible that the engine used had been repainted in the new L.M.S. colour—chocolate red as in the old Midland line.

Exchange of Coaches

Railway coaches have also been exchanged. Passengers from Edinburgh to the South (via Newcastle) may find themselves in Great Eastern Coaches, while in the London district of the late Great Central Railway carriages from the North British line have been seen. Several coaches from the Caledonian Company are being used in England, and these have been marked with a cross to prevent their use on certain sections where their dimensions would render them unsafe. Many similar interchanges of loco and carriage stock might be mentioned, but the above are perhaps the most important.

*Boys!—You can be sure a
Camera is a good Camera
when it bears the name*

APM

There is an Apem Camera to suit everyone and each model is strongly built to last a life-time and so beautifully finished that you can be proud to own one of this fine range of British-Made Cameras.

The ever-popular Box Model only costs 13/6 in the $3\frac{1}{4}'' \times 2\frac{1}{4}''$ size and there are other sizes for those who prefer to take bigger pictures. Then there are the dainty little Vest Pockets and other folding models in all the popular sizes. Send for the free booklet and ask your Dealer to show you the Apem that interests you.

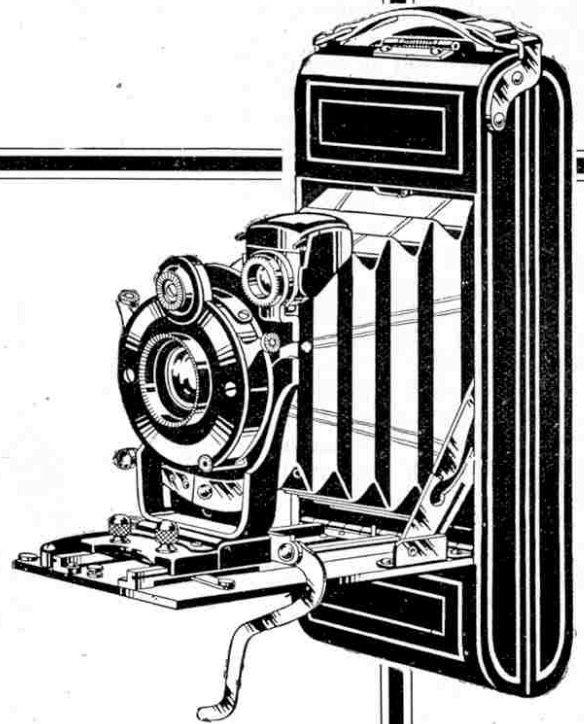

*And when you're buying films
remember to ask for*

RAJAR
GUARANTEED

Their extraordinary speed gives you perfect 'Snaps' even in dull weather and you have

"The Equivalent of a Faster Lens"

STANDARD SIZES TO FIT ALL MAKES OF FILM CAMERAS

FREE BOOKLETS

Have you had your copy of the 64-page book "Sunshine Pictures" or the Rajar Booklet—"Equal to a Faster Lens"? If not, send a P.C. to-day. The booklets are FREE to "M.M." readers.



Amalgamated Photographic Manufacturers Ltd.
SOHO SQUARE, LONDON, W.1