

BRAID THE MECCANO WAY

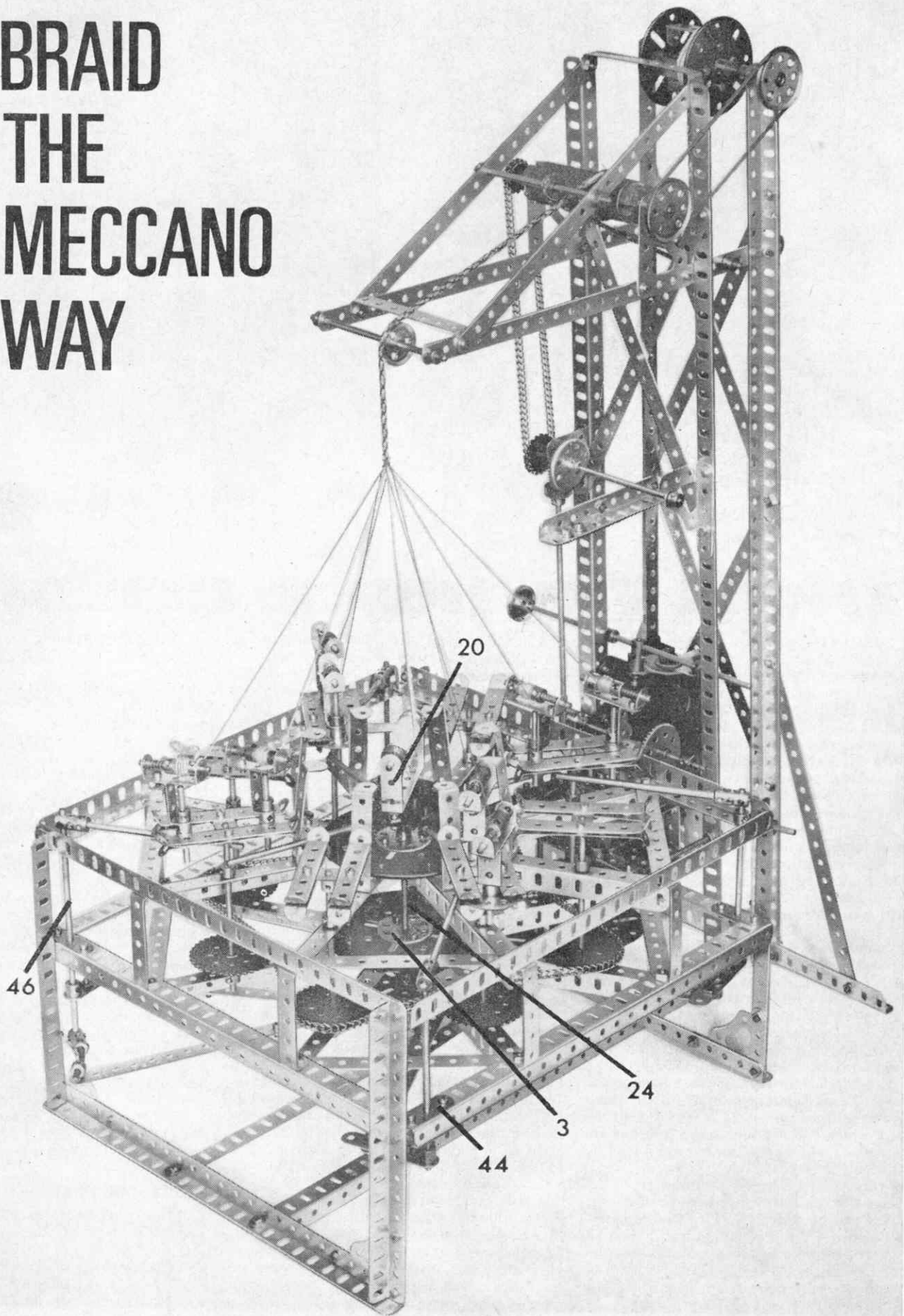

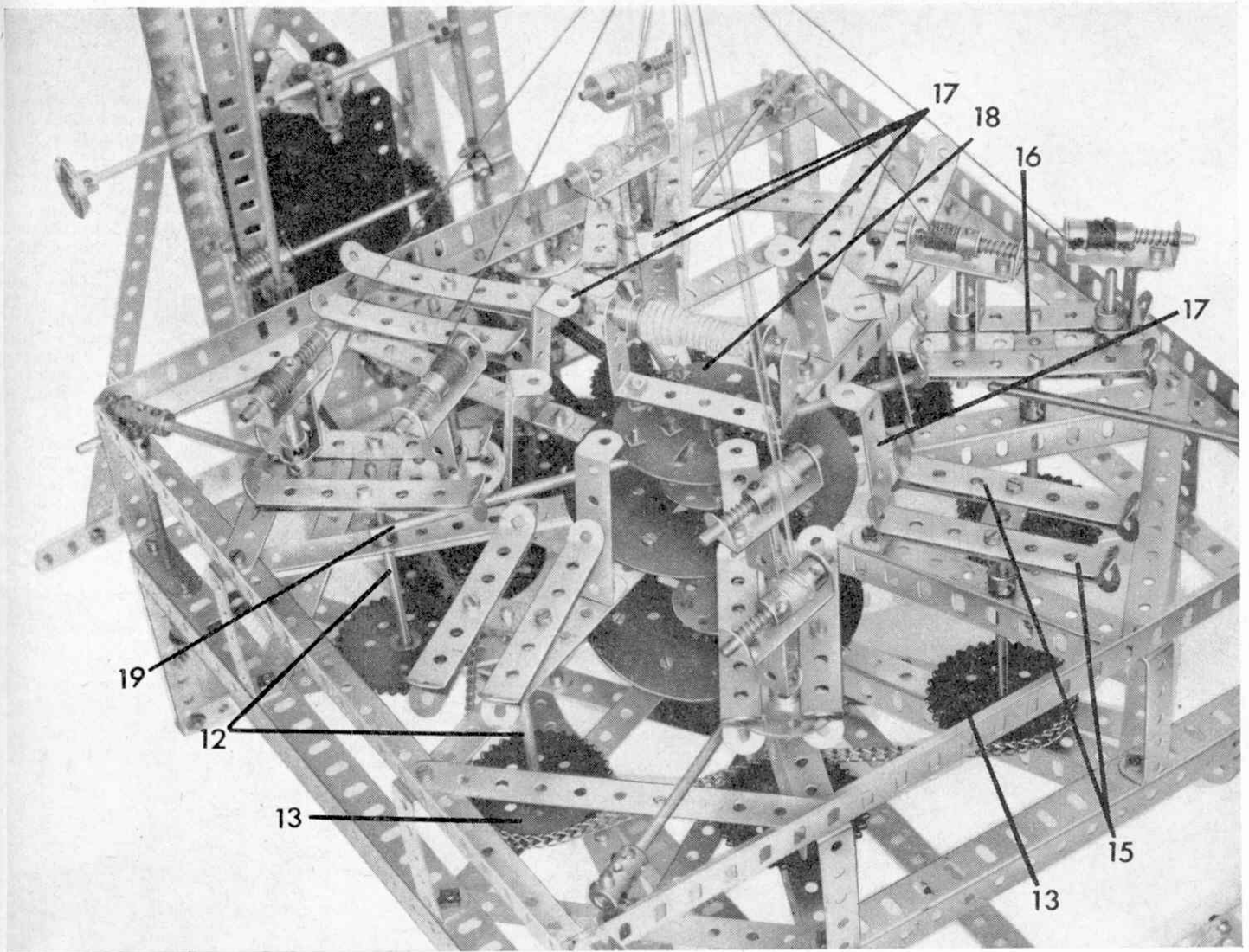

ONE of the most popular large models we have featured in the M.M. recently proved to be the Loom that appeared in the July issue. I believe that this was because it actually wove material and, therefore, I am expanding the theme this month with a working Braiding Machine. The model in question, however, is rather complicated, both in design and operation, and so it is necessary for me to go into great detail. Unfortunately, I don't have enough space in this issue to give all the building instructions required to complete the fine details, and so we will cover as much as possible here, finishing the machine next month.

As you probably know, braiding machines are used for weaving a covering on such things as shoe-laces, some kinds of electric flex, elastic, etc. They are fascinating things to watch in operation, performing all sorts of complex movements. The model described below reproduces all these movements, but I must stress that, because of the complexity of these movements, enormous care must be taken with their setting, and the construction of the moving parts involved. To help follow the

instructions, I have split the model into easily-identified sections, as follows:

Main framework

Two identical units are each obtained by bolting eight 5½ in. Angle Girders 1 to a 4 in. Circular Plate 2, to the centre of which a Wheel Disc 3 is fixed. Great care must be taken to see that the corresponding Angle Girders in the two units lie exactly one above the other. Rods will later be journaled in these Girders, and it is essential that the Rods will be perfectly vertical.

Using 12½ in. Angle Girders, two 'squares' 4 and 5 are built up and are connected together at the corners by four 7½ in. Angle Girders 6, with their elongated-holed flanges pointing outward. The upper square is secured through the top hole of Girders 6, while the lower square is fixed through the seventh hole of the Girders. At two sides, the lower ends of Girders 6 are joined by 12½ in. Angle Girders 7 and 8, Corner Gussets 9 being included to increase rigidity. It is essential that the completed structure is rigid and exactly level.

A 5¼ in. Strip 10 is now bolted

across each corner of both squares at the same time securing six 2½ in. by ½ in. Double Angle Strips 11 between the two squares, two Double Angle Strips along each of three sides. The securing Bolts also fix Girders 1 to the squares.

Seven 4½ in. Rods 12, each carrying a 2 in. Sprocket Wheel 13 are journaled in seven sets of Angle Girders 1, being held in place by Collars. A 6½ in. Rod 14 also carrying a 2 in. Sprocket Wheel, is journaled in the eighth set of Girders. Note that Rods 12 must protrude upwards as far as possible, with Rod 14 protruding a similar distance. A length of new Sprocket Chain is now passed alternately around the outside of one Sprocket Wheel and around the inside of the next, and so on until all eight Wheels have been dealt with, when the ends of the Chain are joined to form an endless belt which should be fairly taut but free-running.

Carrier slides

Eight identical carrier slides are each built up by bolting four 3½ in. Strips 15 to the arms of a Double Arm Crank 16, overlaid by a 1½ in. Strip 16, two to the

upper sides and two to the lower sides of the arms. The ends of Strips 15 are bent to form a sharp 'V' that acts as the 'lead in' for the thread carriers. The completed slides are mounted on Rods 12 and 14, but their position on the Rods is highly critical, therefore great care must be exercised. Each Strip 15 must run exactly parallel to the 5½ in. Angle Girder 1 above which it is mounted, and each end of each slide must be at exactly the same height as the corresponding ends of the adjacent slides at each side. When Rod 11 is turned the ends of adjacent slides must meet exactly without quite touching each other. If they do touch, this means that the ends of Strips 15 have not been sufficiently bent.

Bolted to each upper Angle Girder 1 is a 2½ in. by ½ in. Double Angle Strip 17, its lugs pointing outwards, which is bent inward slightly. This will help to hold the thread carriers in the slides when the model is in motion.

Inside transferring levers

Tightly fixed to the underside of a Face Plate 18 are eight Handrail Supports 20, arranged

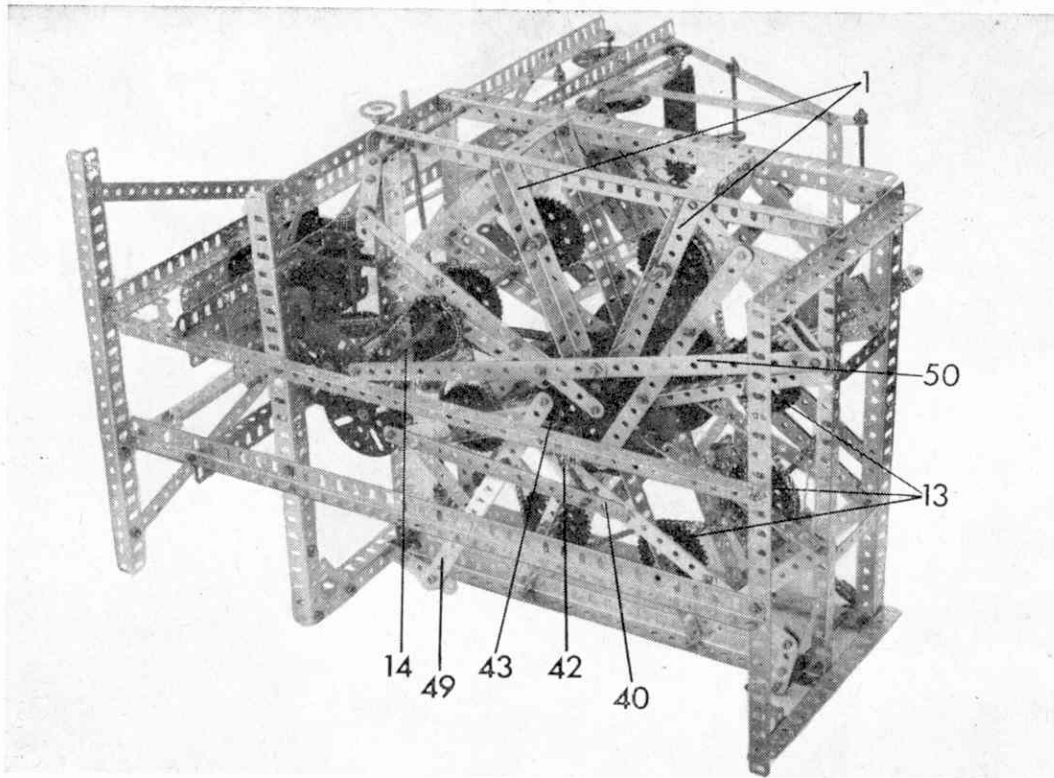

in four pairs with the shanks of the Supports passing through the circular holes in the Face Plate. Four $4\frac{1}{2}$ in. Rods 20 are mounted one in each pair of Handrail Supports, being positioned exactly at right angles, both to each other and to the edge of the Face Plate. A $2\frac{1}{2}$ in. by $1\frac{1}{2}$ in. Double Angle Strip 20 is now fixed to the top of the Face Plate by $\frac{1}{2}$ in. Bolts, with three Nuts positioning it so that it lies just above the boss of the Face Plate. Journalled in the lugs of the Double Angle Strip is a 3 in. Rod held in place by two $\frac{1}{2}$ in. Pulleys 21 and 22. This Rod forms the drum carrying the central or 'insertion' cord 23 around which the braiding will be performed. It is braked by a $2\frac{1}{2}$ in. Driving Band wrapped around one of the Pulleys and fastened to one lug of the Double Angle Strip. A $6\frac{1}{2}$ in. Rod 24 is journalled in Wheel Discs 3 bolted to Circular Plates 2, being held in place by Collars. Faceplate 18 is fixed on the top of the Rod and should lie a distance of one inch above the upper Circular Plate.

A $4\frac{1}{2}$ in. Strip 25 is bolted to the centre of one of the $12\frac{1}{2}$ in. Angle Girders used in square 5 to form a strong bearing for a 4 in. Rod 26 journalled in this Strip and the corresponding

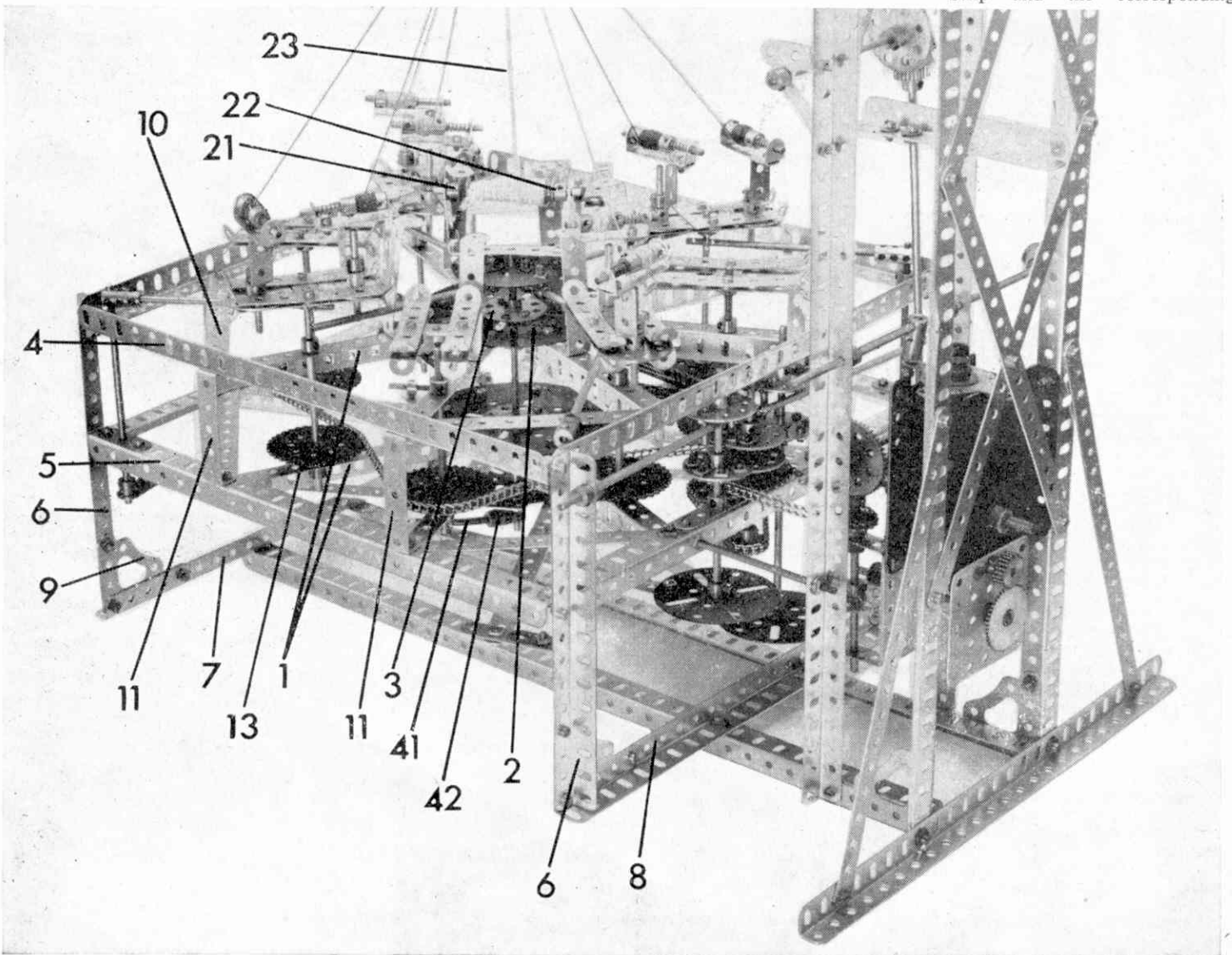

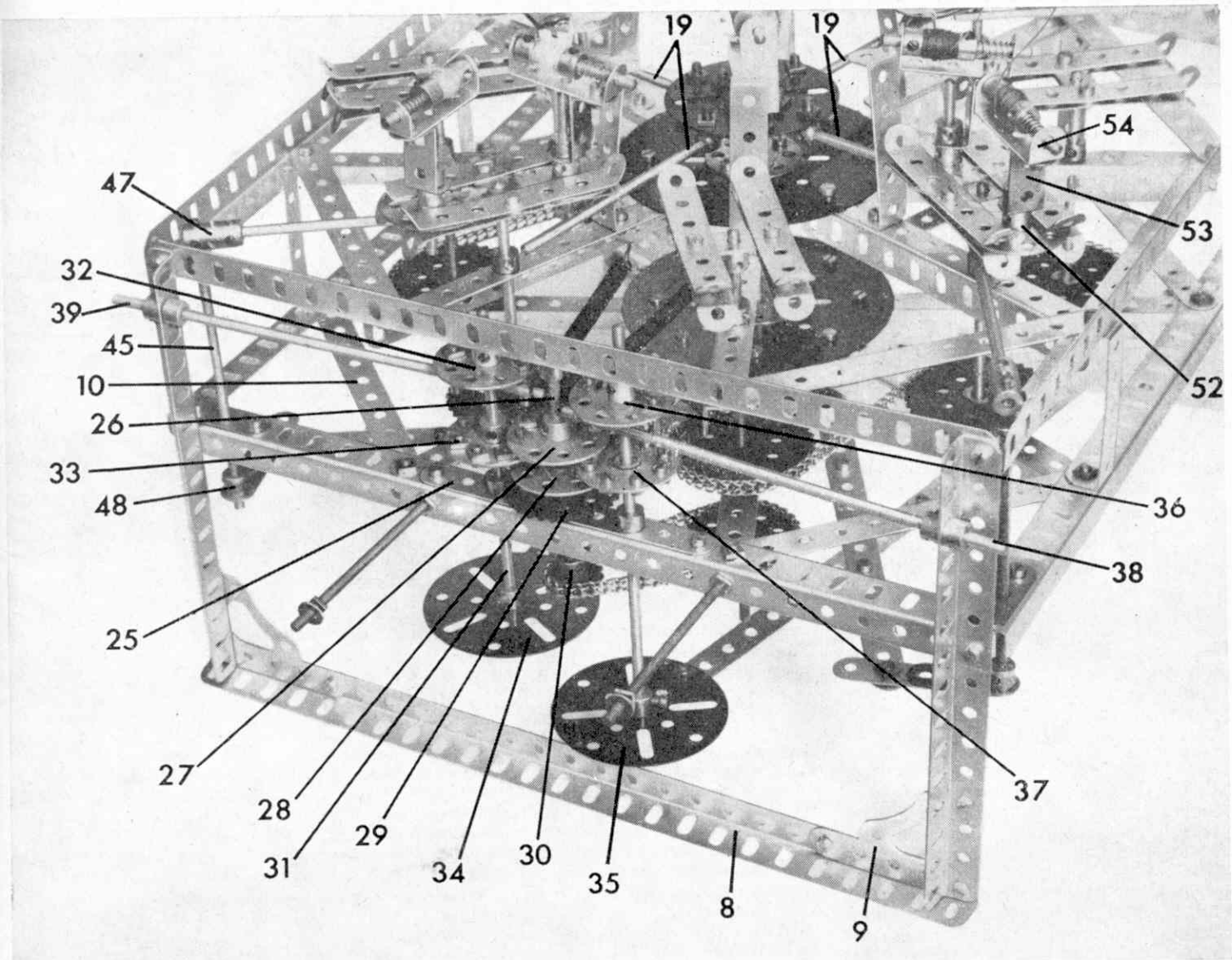

12½ in. Angle Girders. This Rod carries, between the Angle Girders, a Collar, two eight-hole Bush Wheels 27 and 28 and a 1½ in. Sprocket Wheel 29, this Sprocket Wheel and the Collar holding the Rod in place. Bush Wheels 27 and 28 each carry four Bolts, in adjacent holes, held in place by Nuts. It is advisable, incidentally, to secure the Bush Wheels on the Rod with two Grub Screws in each boss. A ¾ in. Sprocket Wheel 30 is added to the lower end of the Rod.

Also journalled in Strip 25 and the corresponding Angle Girders is a 5 in. Rod 31 held in place by Collars. Mounted on this Rod, between the Girders, are two eight-hole Bush Wheels 32 and 33, while a Face Plate 34 is fixed on the lower end of the Rod. Fixed in diametrically opposite holes of Bush Wheel 32 are two Threaded Pins, pointing downwards, whereas eight Bolts are fixed by Nuts in the eight holes in the face of Bush Wheel 33. A 6½ in. Rod, also carrying a Face Plate 35 and two Bush Wheels 36 and 37 with Threaded Pins and Bolts, is itself journalled in Strip 25 and the corresponding Angle Girders. As shown, Bush Wheels 33 and 37 are arranged

so that they lie between Bush Wheels 27 and 28 on Rod 26. When this Rod is revolved the heads of the Bolts fixed in Bush Wheel 27 engage with the heads of the Bolts in Bush Wheel 37, while the Bolts in Bush Wheels 28 and 33 also engage with each other. Two 6½ in. Rods 38 and 39 are loosely held in elongated holes of nearby Angle Girders 6 by Collars, and are held tight against the Threaded Pins in Bush Wheels 32 and 36 by Tension Springs anchored to two Angle Girders 1 by Hooks.

Lock-nutted to Face Plate 34 is a 7½ in. Strip 40 through the third hole from the opposite end of which a Collar is fixed by a Bolt passed into one transverse tapped bore. A Flexible Coupling Unit 41 is held in this Collar and its other end secured in a Coupling 42 mounted on the lower end of Rod 24. Before this Coupling is added, however, a Face Plate 43 is loosely mounted on the Rod. The whole arrangement must be so adjusted that the Flexible Coupling Unit is bent an equal distance in either direction as the revolving action of Face Plate 34 moves Strip 40 to and fro. Note that Rod 38 should rest on both Threaded

Pins in Bush Wheel 32 when Strip 40 is at the maximum limit of its throw in either direction. This will keep the transfer levers in contact with 2½ in. by ½ in. Double Angle Strips 17.

Outside transferring levers

At each corner of the lower square a 1½ in. Strip 44 is bolted. These provide extended bearings for three 5 in. Rods 45 and a 6 in. Rod 46, journalled in the Strips and the corresponding Angle Girders, and held in place by Collars. A Coupling 47, carrying a 4½ in. Rod in its longitudinal bore is mounted on the top of each of these Rods, while a Crank 48 extended by a 2½ in. Strip, is secured on the lower end. Lock-nutted to the 2½ in. Strip is an 8 in. compound strip 49, obtained from two 5½ in. Strips, the other end of which is lock-nutted to Face Plate 43. Note that the strips 49 are lock-nutted through the second holes in the 2½ in. Strips. A 13 in. compound strip 50, obtained from two 7½ in. Strips, is now lock-nutted to Face Plate 35, and is fixed to Rod 46 in the same way as Strip 40 is fixed to Rod

24, i.e. by a Collar, Flexible Coupling Unit and Coupling. Sprocket Wheel 30 is connected by Chain to a 1½ in. Sprocket Wheel 51 secured on Rod 14.

Carrier heads

Eight units, known as 'Carrier Heads', which carry the actual braiding thread, are required, and each is identical in construction. A Bush Wheel 52 is mounted about a half-inch from the end of a 2 in. Rod. A 1 in. by ½ in. Reversed Angle Bracket 53 is then added and is held loosely against the boss of the Bush Wheel by a Collar. Bolted to the upper lug of the Reversed Angle Bracket is a 1½ in. by ½ in. Double Angle Strip 54, in the lugs of which a 2 in. Rod is journalled. Two Collars and a Compression Spring are mounted on this Rod as shown to form a drum.

The carrier heads complete the most difficult sections of the model and, I'm afraid, are the last parts that we have room for this month. Next month I will describe construction of the take-up framework, the method of drive and how to prepare the model for braiding.—Spanner.

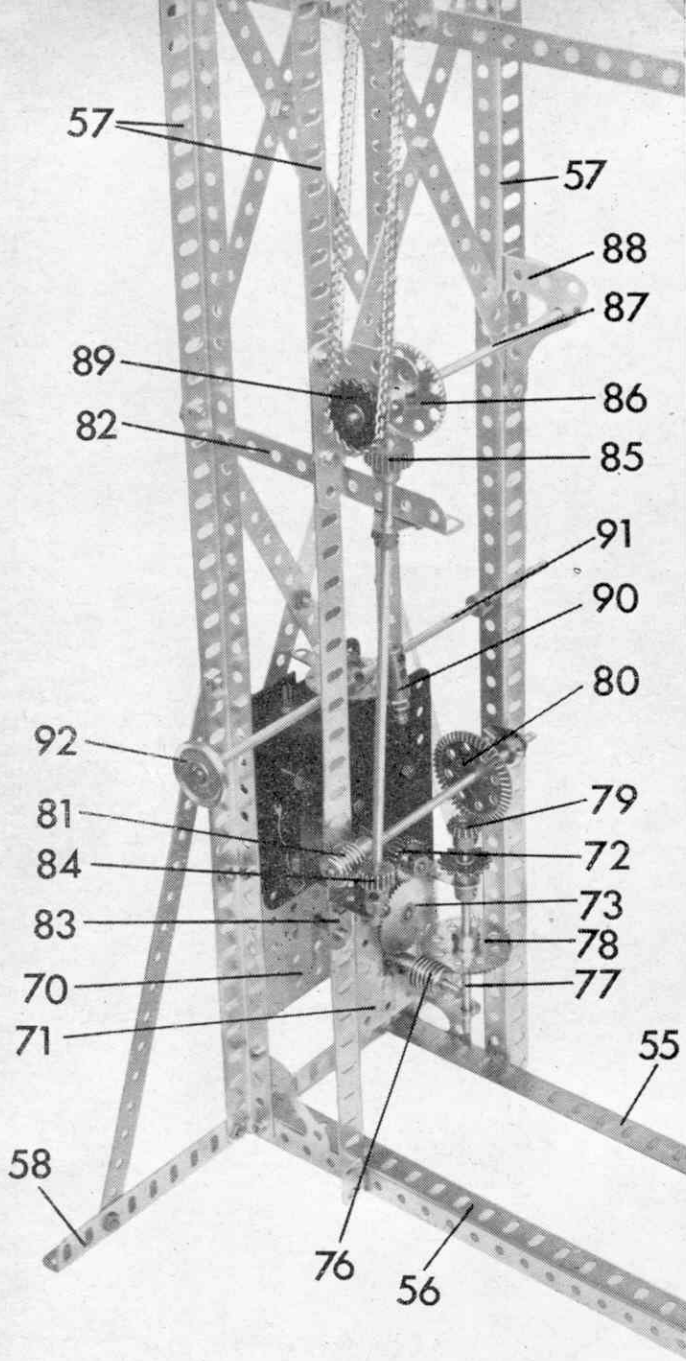

The lower portion of the take-up framework, including the Motor and drive gearing

A view showing the upper portion of the take-up framework

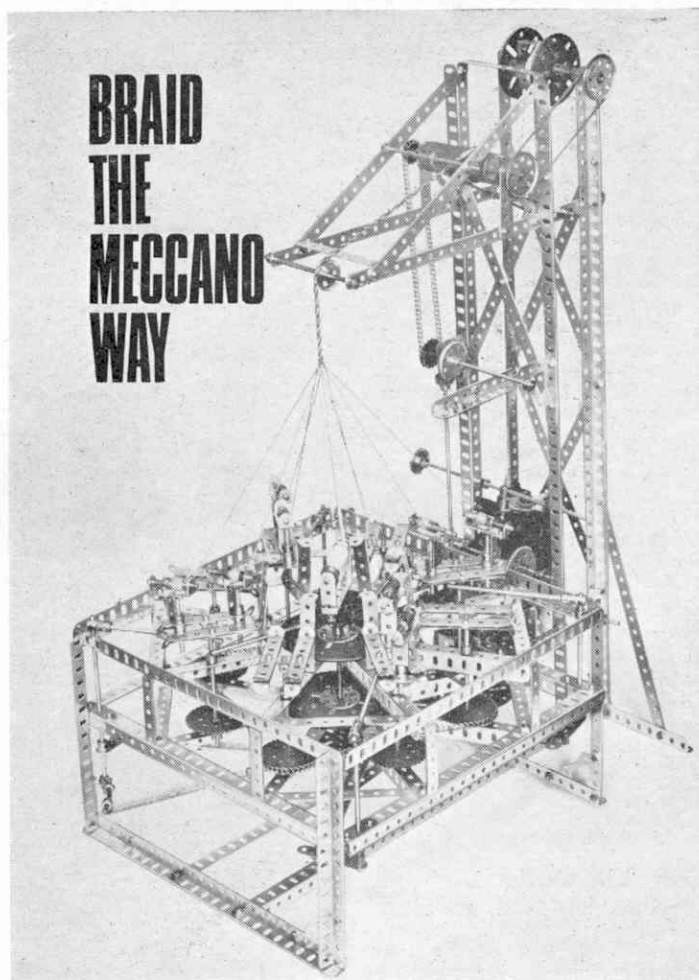
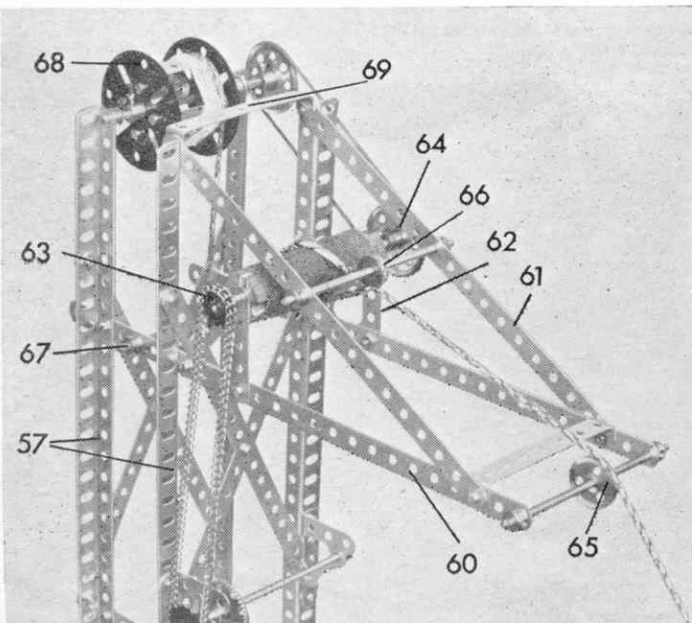

IN the first part of the building instructions for the Meccano Braiding Machine featured last month, I described construction of the main framework, the thread carriers, their slides and the transferring mechanism which moves the carriers from one slide to another. All that remains to be built is the take-up framework, incorporating the Motor and the main drive gearing for both the take-up mechanism and the braiding operation mechanism. Before beginning this, however, it is advisable to set the timing of the various movements involved in the actual braiding operation. The correct timing of these movements is absolutely essential for the success of the model, therefore great care must be exercised.

Taking the section of the model completed last month, rotate Sprocket Wheel 30 in a clockwise direction until all the carrier slides are facing the centre of the model. By turning a further distance of one tooth, studded Bush Wheel 27 should engage with studded Bush Wheel 37. Just before adjacent carrier slides are in line with each other, the outside transferring levers held in Couplings 47 should begin to move taking the thread carriers or 'carrier heads' across from one carrier slide to the other when the 'Vs' in the slides are exactly opposite each other (see diagrams 1 and 2). With the Sprocket Wheel being further rotated the 'spring' in the Flexible Coupling Unit should cause the transferring levers to follow the carrier heads until they are right 'home' in the slides.

When the third Bolt in Bush Wheel 27 is engaging with Bush Wheel 37, the first Bolt in Bush Wheel 28 should engage with the Bolts in Bush Wheel 33. This will give the correct timing for the inside transferring levers. Remember that the carrier heads must move only when the respective slides are opposite each other and note that the outside transferring levers must bear against Rods 10 and 11 after each movement. It is advisable to oil the carrier heads and slides to reduce the danger of the heads binding in the slides.

Take-up Framework

Two 18½ in. Angle Girders 55 and 56 are now bolted as shown between Angle Girders 8, then four 24½ in. Angle Girders 57 are secured to these at right angles, with Corner Gussets again providing rigidity. Secured between the outer two Angle Girders 57 is a 12½ in. Angle Girder 58, braced by 9½ in. Strips, while Angle Girders 57 are themselves braced, generally, by various 9½ in. Strips, as shown. Inner Girders 57 are connected to square 5 by two 3½ in. Screwed Rods 59. Bolted towards the top of Angle Girders 57 are two 12½ in. Strips 60, also braced by 9½ in. Strips 61. Two Corner Gussets 62 are fixed to Strips 60 to provide bearings for a Wood Roller which should be covered with sand paper. Mounted on the axle of the Roller at opposite ends are a ½ in. Sprocket Wheel 63 and a 1½ in. Pulley 64.

A 4½ in. Rod carrying a 1 in.

loose Pulley 65 is journalled in the end holes of Strips 60, while a similar Rod carrying a $\frac{1}{2}$ in. loose Pulley 66 is journalled in Strips 61, both being held in place by Collars. Another $4\frac{1}{2}$ in. Rod 67, carrying a $\frac{1}{2}$ in. loose Pulley is journalled in Strips 60 between Angle Girders 57. A drum is now built up from two Face Plates 68, joined by four $1\frac{1}{2}$ in. by $\frac{1}{2}$ in. Double Angle Strips, and is mounted on a 5 in. Rod, held by Collars in the upper end holes of outside Girders 57. A second $1\frac{1}{2}$ in. Pulley is fixed on the end of this Rod and is connected to Pulley 64 by a Driving Band. The upper ends of inner Girders 57, by the way, are joined by a $3\frac{1}{2}$ in. Double Angle Strip 69.

Power Unit

An E15R Electric Motor is mounted on two Angle Girders 57, its sideplates having first been extended by two $2\frac{1}{2}$ in. by $2\frac{1}{2}$ in. Flat Plates 70 and 71. Secured on the Motor output shaft is a $\frac{1}{4}$ in. Pinion 72 that meshes with a 50-teeth Gear 73 on a $2\frac{1}{2}$ in. Rod, journalled in the Motor sideplates. A second $\frac{1}{4}$ in. Pinion 74 on the other end of this Rod engages with a second 50-teeth Gear 75 on a $3\frac{1}{2}$ in. Rod, mounted in Flat Plates 70 and 71 and held by a Collar. A Worm 76 is fixed on the inside end of this Rod. Bolted along one edge of Flat Plate 71 is a $2\frac{1}{2}$ in. by 1 in. Double Angle Strip, the lugs of which provide bearings for a 4 in. Rod 77. Secured on this Rod are a 57-teeth Gear 78, in mesh with Worm 76, a Collar, a $\frac{3}{4}$ in. Sprocket Wheel and a $\frac{1}{2}$ in. Bevel Gear 79. In mesh with Bevel Gear 79 is a $1\frac{1}{2}$ in. Bevel Gear 80 on a 5 in. Rod which is journalled in two Fish-plates bolted to Girder 57. A Collar and a Worm 81 hold the Rod in place. The $\frac{1}{2}$ in. Sprocket Wheel on Rod 77 is connected by Chain to Sprocket Wheel 29.

Bolted to two side Girders 57 is a $4\frac{1}{2}$ in. Angle Girder 82, to which a 1 in. Triangular Plate is fixed. A 1 in. by 1 in. Angle Bracket 83 is bolted to inside Girder 57, on the same side, then an 8 in. Rod is journalled in this and in the apex hole of the Triangular Plate, Collars holding it in position. A $\frac{1}{2}$ in. Pinion 84 on the Rod engages with Worm 81, while a $\frac{3}{4}$ in. Pinion 85, fixed on its upper end, engages with a $1\frac{1}{2}$ in. Conrate Wheel 86, mounted on a 5 in. Rod 87. This Rod is held by Collars in left-hand and right-hand Flanged Brackets 88, bolted to Girders 57. Also mounted on the Rod is a 1 in. Sprocket Wheel 89 that is connected by Chain to Sprocket Wheel 63.

A start stop lever for the Motor is obtained by loosely fixing a Threaded Coupling 90 to one arm of the Motor switch by a Nut and Bolt. An 8 in. Rod 91 is then passed through inside Girders 57 and is fixed in the upper transverse smooth bore of the Threaded Coupling. A 1 in. Pulley with boss 92 is mounted on the end of the Rod. It is very important that the model should operate in one direction only—the Sprocket Chain connecting Sprocket Wheels 13 should move clockwise. Collars are, therefore, added to Rod 91 to provide "stops" preventing the Motor from being reversed by mistake.

Braiding Preparation

Providing that all the building instructions have been followed, you should now have a complete braiding machine, but without the necessary cord and thread. A fairly thick central cord is required, and this can be provided by heavy string. The outside threads, however, should be pretty fine and we recommend Sylko No. 20.

To prepare the model, the central drum composed of the 3 in. Rod, carrying Pulleys 21 and 22, is wound with the thick cord, while each of the small drums in the carrier heads are wound with fine thread. All eight fine threads, together with the central cord, are now taken over Pulley 65, over and around the Wood Roller, over and around the

$\frac{1}{2}$ in. Pulley 66, under and around the Pulley on Rod 67 to be finally attached to the axle of the take-up drum 68.

When the model is in operation you will see that the eight carrier heads work in two groups of four, each group moving only when one of the two square patterns (see diagrams 1 and 2) are formed by the carrier slides. The sides of the pattern shown in diagram 1 should be parallel to the respective $12\frac{1}{2}$ in. Angle Girders in the main framework while the sides of the pattern shown in diagram 2 should be at angles of 45 degrees to the framework Girders. I must again stress that exact positioning of the slides is essential, therefore, I suggest that you make frequent checks with this in mind.

by Spanner

Parts required:-

2 of No. 1	1 of No. 15b	240 of No. 37a	8 of No. 95
10 of No. 1a	2 of No. 16	194 of No. 37b	2 of No. 95a
3 of No. 1b	1 of No. 16a	12 of No. 38	1 of No. 96
24 of No. 2	1 of No. 16b	2 of No. 43	3 of No. 96a
1 of No. 2a	16 of No. 17	1 of No. 46	1 of No. 106
32 of No. 3	2 of No. 21	1 of No. 47	10 of No. 180
4 of No. 5	1 of No. 22	12 of No. 48	4 of No. 109
12 of No. 6a	1 of No. 22a	14 of No. 48a	2 of No. 111a
4 of No. 7	2 of No. 23	2 of No. 48b	2 of No. 111c
2 of No. 7a	2 of No. 23a	2 of No. 57d	4 of No. 115
11 of No. 8	14 of No. 24	78 of No. 59	8 of No. 120b
4 of No. 8b	2 of No. 24a	4 of No. 62	8 of No. 124
16 of No. 9	3 of No. 25	8 of No. 62b	1 of No. 133a
1 of No. 9a	1 of No. 26	5 of No. 63	8 of No. 136
3 of No. 10	2 of No. 27	1 of No. 63c	1 of No. 139
1 of No. 12a	1 of No. 27a	24 of No. 69	1 of No. 139a
1 of No. 13a	1 of No. 28	16 of No. 69c	2 of No. 146a
6 of No. 14	1 of No. 30a	2 of No. 72	2 of No. 175
6 of No. 15	1 of No. 30c	2 of No. 80a	1 of No. 186
19 of No. 15a	2 of No. 32	2 of No. 94	1 of No. 186c
			1 E15R Electric Motor

A rear view of the Braiding Machine showing the method of securing the take-up framework to the main framework. Most of the numbers appearing on the picture were referred to in last month's article

These diagrams show the two main patterns formed by the carrier slides when the model is in operation. As slides X and Y are forming the pattern shown in diagram 1, the carrier heads A and B must be in the positions shown. At the moment the correct pattern is formed carrier heads B in slides X are moved by the transferring levers to slides Y, as shown in diagram 2. When the pattern shown in diagram 2 is formed by the carrier slides, carrier heads A in slides X are moved into slides Y, then the cycle is repeated

